

AWK-4131A Series Quick Installation Guide

Moxa AirWorks

Version 6.1, January 2021

Technical Support Contact Information
www.moxa.com/support

MOXA®

© 2021 Moxa Inc. All rights reserved.

P/N: 1802041310025



Table of Contents

Overview	- 3 -
Hardware Setup	- 3 -
Package Checklist	- 3 -
Panel Layout of the AWK-4131A	- 4 -
Mounting Dimensions	- 5 -
Attaching Antennas	- 5 -
Wall Mounting	- 6 -
DIN-Rail Mounting (Optional)	- 7 -
To Install	- 7 -
To Release	- 7 -
Deployment Precautions	- 8 -
Wiring Requirements	- 8 -
Grounding the AWK-4131A	- 8 -
Installations with Cable-Extended Antennas for Outdoor Applications	- 8 -
Wiring the Redundant Power Inputs	- 9 -
Wiring the Digital Inputs and Relay Contact (Digital Output) ...	- 10 -
Communication Connections	- 10 -
10/100BaseT(X) Ethernet Port Connection	- 10 -
1000BaseT Ethernet Port Connection	- 11 -
RS-232 Connection	- 11 -
Waterproofing the RJ45 Plug	- 12 -
LED Indicators	- 13 -
Specifications	- 14 -
Software Setup	- 15 -
How to Access the AWK	- 15 -
First-Time Quick Configuration	- 16 -
Point-to-Multipoint Scenario (AP/Client Mode)	- 16 -
Point-to-Point Scenario (Master/slave mode)	- 18 -

Overview

The AWK-4131A IP68 outdoor industrial AP/bridge/client meets the growing need for faster data transmission speeds by supporting 802.11n technology and allowing 2X2 MIMO communication with a net data rate of up to 300 Mbps. The AWK-4131A is compliant with industrial standards and approvals covering operating temperature, power input voltage, surge, ESD, and vibration. The two redundant DC power inputs increase the reliability of the power supply, and the AWK-4131A can be powered via PoE to make deployment easier. The AWK-4131A can operate on either the 2.4 or 5 GHz bands and is backwards compatible with existing 802.11a/b/g deployments to future-proof your investments in wireless networks.

Notes for the Reader



WARNING

Indicates that death or personal injury may occur if proper precautions are not taken.



ATTENTION

Indicates that possible damage to this product or your property may result if proper precautions are not taken.

NOTE Highlights important information related to this product.

Hardware Setup

This section covers the hardware setup of the AWK-4131A.

Package Checklist

Moxa's AWK-4131A is shipped with the following items. If any of these items are missing or damaged, please contact your customer service representative for assistance.

- AWK-4131A wireless AP/bridge/client
- 2 2.4/5 GHz antennas: ANT-WDB-ANM-0306
- Wall-mounting kit (includes 2 supports)
- Field-installable power plug
- Field-installable RJ45 plug
- Metal cap to cover RJ45 connector
- Metal cap to cover M12 female connector
- Transparent plastic sticks for field-installable plugs
- Quick installation guide (printed)
- Warranty card

NOTE The above items come with the AWK-4131A standard version. The package contents for customized versions may be different.

Panel Layout of the AWK-4131A

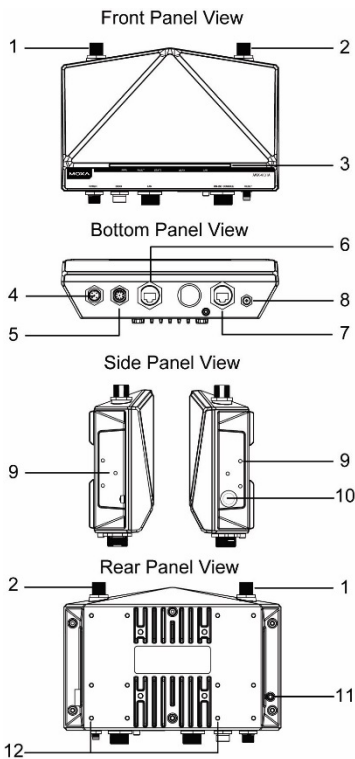

1. Antenna A port
2. Antenna B port
3. LEDs for PWR, FAULT, STATE, WLAN, and LAN
4. M12 A-coded connector for PWR1 and PWR2
5. M12 8-pin connector for DI/DO
6. 10/100/1000BaseT(X) RJ45 Port
7. RS-232 console port
8. Reset button
9. Screw holes for wall mounting
10. Waterproof vent
11. Grounding screw (M4)
12. Screw holes for DIN-rail mounting



ATTENTION

Please DO NOT open or remove the vent **10**. The warranty will be invalid if the seal is removed.

All exposed connectors, including **1, 2, 4 - 8**, should be tightly covered with suitable caps when they are not in use.

Mounting Dimensions

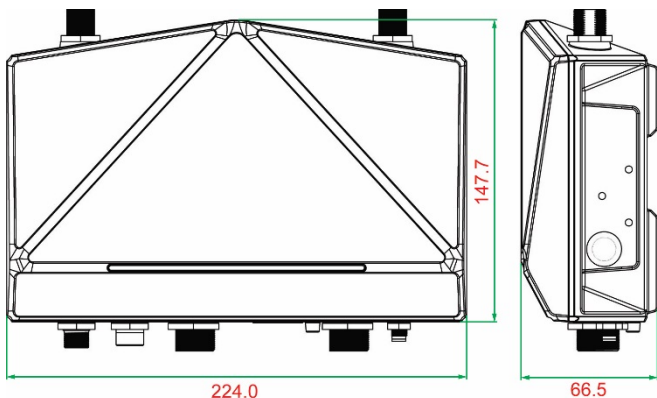

Unit = mm

Attaching Antennas

By default, the AWK-4131A comes with two dual-band omni-directional antennas. Attach the antennas as illustrated below:

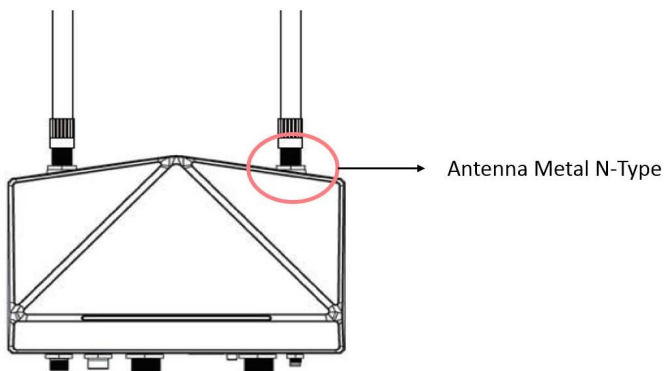

STEP 1:

Use your fingers to hold the antenna N-type connector (female) on the AWK-4131A.

STEP 2:

Screw the antenna N-type connector (male) onto the AWK-4131A device's N-type connector.



Caution

For additional stability, hold the antenna connector when you screw on an antenna to the AWK-4131A device.



ATTENTION

Use the correct antennas: Use the 2.4 GHz antenna if the AWK-4131A will operate in IEEE 802.11b/g/n. Use the 5GHz antenna for operations in IEEE802.11a/n. Make sure the antennas are installed in a safe outdoor area and are protected against lightning and surge current using surge protection systems.

Wall Mounting

In most applications, wall mount provides an easier installation. You will find it quite easy to mount AWK-4131A on the wall, as illustrated below.

STEP 1:

Attach the wall-mounting kit with M4 screws, as shown in the diagram below.

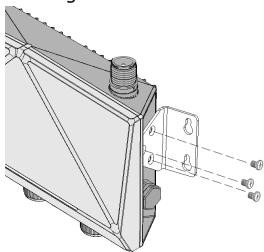

STEP 2:

Mounting the AWK-4131A on the wall requires 4 screws. Use the AWK-4131A device, with wall-mounting kit attached, as a guide to mark the correct locations of the 4 screws. The heads of the screws are recommended to be between 5.5 mm and 8.5 mm in diameter, and the shafts should not be more than 5.0 mm in diameter, as shown in the figure.

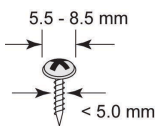

Do not drive the screws in all the way into the wall—leave a space of about 2 mm to allow room for sliding the wall-mounting kit between the wall and the screws.



ATTENTION

Test the screw head and shank size by inserting the screws into one of the keyhole shaped apertures of the wall-mounting plates before attaching the plate to the wall.

STEP 3:

Once the screws are fixed into the wall, insert the four screw heads through the large opening of the keyhole-shaped apertures on the AWK-4131A, and then slide the AWK-4131A downwards, as indicated in the illustration on the right. Tighten the four screws for added stability.

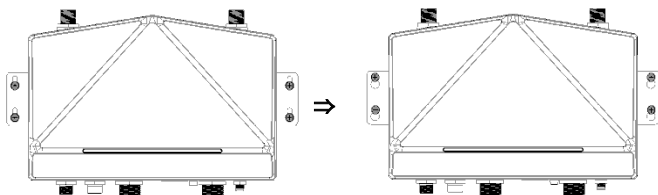



ATTENTION

To avoid environmental vibration or shock, you can consider a robust installation with four bigger screws, where the shafts are between 7.0 mm and 8.5 mm in diameter, and fix the AWK-4131A directly onto the wall and tighten the screws.

DIN-Rail Mounting (Optional)

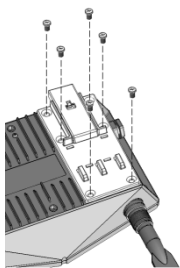

The DK-DC50131 die-cast metal kit, which can be bought separately, enables easy and robust installation for the AWK-4131A. A pair of DK-DC50131s is needed to DIN-rail mount the AWK-4131A. To install the DIN-rail mounting kits, tightly attach the two DIN-rail mounting kits on to the rear panel of the AWK-4131A using 6 screws for each kit.

To Install

STEP 1:

Use the recessed button on the spring-loaded bracket to lock it into position.

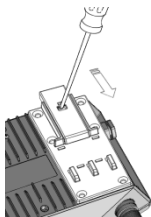

STEP 2:

Insert the top of the DIN rail into the slot just below the upper hook of the DIN-rail mounting kit. Push the AWK-4131A toward the DIN rail until the DIN-rail attachment bracket snaps into place.

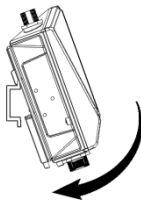

To Release

STEP 1:

Use a screw driver to pull down the two spring-loaded brackets from the bottom until they are fixed in the "release" position.

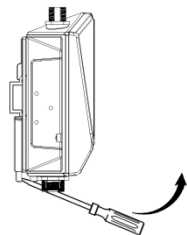

STEP 2:

Pull the AWK-4131A out and upward.

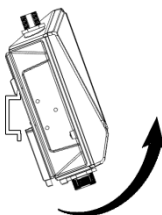

Deployment Precautions

Wiring Requirements



WARNING

Safety First!

Be sure to disconnect the power cord before installing and/or wiring your AWK-4131A.

Calculate the maximum possible current in each power wire and common wire. Observe all electrical codes dictating the maximum current allowable for each wire size. If the current goes above the maximum ratings, the wiring could overheat, causing serious damage to your equipment.

You should also pay attention to the following items:

- Use separate paths to route wiring for power and devices. If power wiring and device wiring paths must cross, make sure the wires are perpendicular at the intersection point.

NOTE Do not run signal or communications wiring and power wiring in the same wire conduit. To avoid interference, wires with different signal characteristics should be routed separately.

- You can use the type of signal transmitted through a wire to determine which wires should be kept separate. The rule of thumb is that wiring with similar electrical characteristics can be bundled together.
- Keep input wiring and output wiring separate.
- It is strongly advised that you label wiring to all devices in the system when necessary.

Grounding the AWK-4131A

Grounding and wire routing help limit the effects of noise due to electromagnetic interference (EMI). Run the ground connection from the ground screw to the grounding surface prior to connecting devices.



ATTENTION

This product is intended to be mounted to a well-grounded mounting surface, such as a metal panel. There must be no electrical potential difference between any two grounding points; otherwise, there is a risk that the device could be destroyed.

Installations with Cable-Extended Antennas for Outdoor Applications

If the antenna or the AWK device is installed outdoors or in an open-air setting, proper lightning protection is required to prevent direct lightning strikes on the AWK device. In order to prevent coupling currents from nearby lightning strikes, a lightning arrester should be installed as part of your antenna system. Ground the device, antenna, as well as the arrester properly to provide maximum outdoor protection for the device.

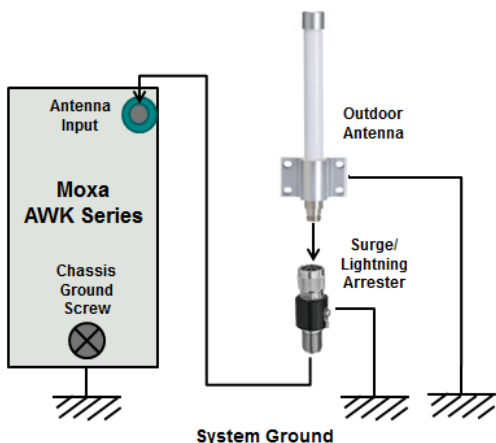

Arrester Accessories

- **SA-NMNF-01:** Surge arrester, N-type (male) to N-type (female)
- **SA-NFNF-01:** Surge arrester, N-type (female) to N-type (female)

Wiring the Redundant Power Inputs

The AWK-4131A must be connected to a Power-over-Ethernet (PoE) IEEE 802.3af compliant power source or an IEC60950 compliant limited power source. When AWK-4131A is powered via DC power, the M12 A-coded connector on the bottom panel is used for the AWK-4131A's two redundant inputs. The pin assignment is shown below:

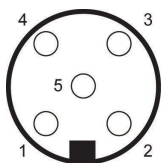

Pin	Power Input
1	V1+
2	V2+
3	V1-
4	V2-
5	GND



ATTENTION

This product is intended to be supplied by a Listed Power Unit marked "Class 2" or "LPS" and rated O/P: 7.68 W

Make sure the external power adaptor (includes power cords and plug assemblies) provided with the unit is certified and suitable for use in your country.

Before connecting the AWK-4131A to the DC power inputs, make sure the DC power source voltage is stable.

Wiring the Digital Inputs and Relay Contact (Digital Output)

The AWK-4131A has two sets of digital input—DI1 and DI2. Each DI comprises of two contacts of the 8-pin M12 connector on the AWK-4131A's bottom panel. These two digital inputs can be connected to digital-output-enabled sensors for on-site status monitoring.

The AWK-4131A also has one relay output, which consists of the two contacts. These relay contacts are used to detect user-configured events. The two wires attached to the Relay contacts form an open circuit when a user-configured event is triggered. If a user-configured event does not occur, the Relay circuit will be closed.

A field-installable plug, **M12A-8PMM-IP68**, is recommended for connecting the AWK-4131A's DIs and relay.

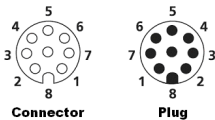
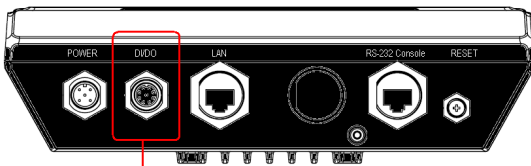

Pin	Signal
1	Relay
2	
3	DI1 I1
4	DI1 COM_1
5	DI2 I2
6	DI2 COM_2
7	Reserved
8	

Communication Connections

10/100BaseT(X) Ethernet Port Connection

The 10/100BaseT(X) ports located on the AWK-4131A's bottom panel are used to connect to Ethernet-enabled devices.

The pinouts for both MDI (NIC-type) ports and MDI-X (HUB/Switch-type) ports are shown below:

MDI Port Pinouts

Pin	Signal
1	Tx+
2	Tx-
3	Rx+
6	Rx-

MDI-X Port Pinouts

Pin	Signal
1	Rx+
2	Rx-
3	Tx+
6	Tx-

8-pin RJ45

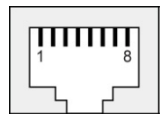

1000BaseT Ethernet Port Connection

1000BaseT data is transmitted on differential TRD+/- signal pairs over copper wires.

MDI/MDI-X Port Pinouts

Pin	Signal
1	TRD(0)+
2	TRD(0)-
3	TRD(1)+
4	TRD(2)+
5	TRD(2)-
6	TRD(1)-
7	TRD(3)+
8	TRD(3)-

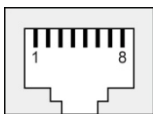

RS-232 Connection

The AWK-4131A has one RS-232 (8-pin RJ45) console port located on the bottom panel. Use either an RJ45-to-DB9 or RJ45-to-DB25 cable to connect the AWK-4131A's console port to your PC's COM port. You may then use a console terminal program to access the AWK-4131A for console configuration.

Console Pinouts for 10-pin or 8-pin RJ45

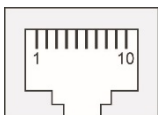

10-Pin	Description	8-Pin
1	-	-
2	DSR	1
3	RTS	2
4	GND	3
5	TxD	4
6	RxD	5
7	DCD	6
8	CTS	7
9	DTR	8
10	-	-

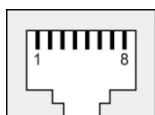

- NOTE**
1. The pin numbers for the DB9 and DB25 male connectors, and hole numbers for the DB9 and DB25 female connectors are labeled on the connector strip. However, the numbers are typically quite small, so you may need to use a magnifying glass to see the numbers clearly.
 2. The pin numbers for both the 8-pin and 10-pin RJ45 connectors (and ports) are typically not labeled on the connector strip (or port). Refer to the pinout diagram above for details.



ATTENTION

To ensure the IP68-rated connectivity, you must use a waterproof housing during any communication activities. An IP68-rated field installable plug, which is provided in AWK-4131A's accessory pack, may be needed in this case. The installation instructions are shown below.

Waterproofing the RJ45 Plug

Dimensions (unit: mm)

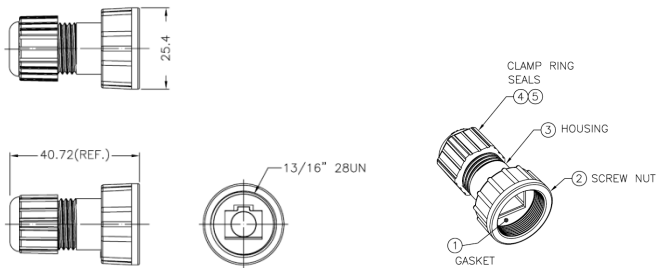

Installation

STEP 1:

Attach the gasket ① to the housing ③

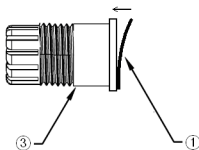

STEP 2:

Insert the cable (e.g., CAT5e) through the clamp ring ④, screw nut ②, seal ⑤ and housing ③, as follows:

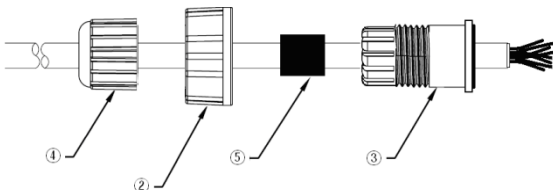

STEP 3:

Crimp the modular RJ plug to the cable. Note that the use of a snagless cover shield or a strain-relief boot is not recommended here. After you have crimped the cable, assemble the seal and the housing (③ and ⑤) as indicated below:

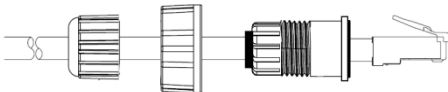

STEP 4:

Tightly screw on the clamp ring ④ to the housing and check to make sure that the plug is securely fastened.

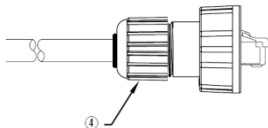

NOTE For a tighter connection, you can connect the RJ45 plug to the AWK-4131A before **STEP 4**.

LED Indicators

The front panel of the AWK-4131A contains several LED indicators. The function of each LED is described in the table below:

LED	Color	State	Description
Front Panel LED Indicators (System)			
PWR	Green	On	Power is being supplied(from power input 1 or 2, or PoE).
		Off	Power is not being supplied.
FAULT	Red	Blinking (slow at 1-second intervals)	Cannot get an IP address from the DHCP server.
		Blinking (fast at 0.5-second intervals)	IP address conflict.
		Off	No error condition exists.
STATE	Green	On	System startup is complete and the system is in operation.
		Blinking (slow at 1-second intervals)	Device has been located by the Wireless Search Utility
		Blinking (fast at 0.5-second intervals)	AeroLink Protection is enabled and is currently in "Backup" state
	Red	On	System is booting up
WLAN	Green	On	WLAN function is in client/client-router/slave mode.
		Blinking	WLAN's data communication is running in client/client-router/slave mode.
		Off	WLAN is not in operation.
	Amber	On	WLAN function is in AP/bridge mode.
		Blinking	WLAN's data communication is running in AP/master mode
		Off	WLAN is not in operation.
LAN	Green	On	LAN port's 1000 Mbps link is active .
		Blinking	Data is being transmitted at 1000 Mbps
		Off	LAN port's 1000 Mbps link is inactive .
	Amber	On	LAN port's 10/100 Mbps link is active .
		Blinking	Data is being transmitted at 10/100 Mbps
		Off	LAN port's 10/100 Mbps link is inactive .

Specifications

Input Current	0.64 A @ 12 VDC; 0.16 A @ 48 VDC
Input Voltage	12 to 48 VDC, redundant dual DC power inputs or 48 VDC Power-over-Ethernet (IEEE 802.3af compliant)
Power Consumption	7.68 W
Operating Temperature	-40 to 75°C (-40 to 167°F)
Storage Temperature	-40 to 85°C (-40 to 185°F)



ATTENTION

The AWK-4131A is **NOT** a portable mobile device and should be located 20 cm away from the human body.

The AWK-4131A is **NOT** designed for the general public. A well-trained technician is required to deploy AWK-4131As and safely establish a wireless network.



ATTENTION

This device complies with part 15 of the FCC Rules. Operation is subject to the following two conditions:

1. This device may not cause harmful interference, and
2. This device must accept any interference received, including interference that may cause undesired operation.



ATTENTION

Do not locate the antenna near overhead power lines or other electric light or power circuits, or where it can come into contact with such circuits. When installing the antenna, take extreme care not to come into contact with such circuits, because they may cause serious injury or death. For proper installation and grounding of the antenna, refer to national and local codes (for example, U.S.: NFPA 70; National Electrical Code (NEC) Article 810; Canada: Canadian Electrical Code Section 54).

NOTE For installation flexibility, either the antenna A or the antenna B may be selected for use. Make sure the antenna connection matches the antenna configured in the AWK-4131A web interface.

To protect the connectors and RF module, all radio ports should be terminated by either an antenna or a terminator. We strongly recommend using resistive terminators for terminating the unused antenna ports.

Software Setup

This section covers the software setup of the AWK-4131A.

How to Access the AWK

Before installing the AWK device (AWK), make sure that all items in the package checklist are provided in the product box. You will also need access to a notebook computer or PC equipped with an Ethernet port.

- **Step 1: Select a suitable power source and plug in the AWK.**

The AWK can be powered by DC power ranging from **12 VDC to 48 VDC** or by a **PoE PSE** via an Ethernet connection.

- **Step 2: Connect the AWK to the notebook or PC via the AWK's LAN port.**

The LED indicator on the AWK's LAN port will light up when a connection is established.

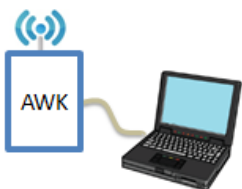

NOTE If you are using an Ethernet-to-USB adapter, follow the instructions in the user's manual provided with the adapter.

- **Step 3: Set up the computer's IP address**

Choose an IP address for the computer that is on the same subnet as the AWK. Since the AWK's default IP address is **192.168.127.253**, and the subnet mask is **255.255.255.0**, set the IP address to **192.168.127.xxx**, where xxx is between 1 and 252.

- **Step 4: Access the homepage of the AWK.**

Open your computer's web browser and type **http://192.168.127.253** in the address field to access the AWK's homepage. Log in using the following default username and password:

Default Username: **admin**

Default Password: **moxa**

Click the **Login** button to access the homepage of the AWK device.

First-Time Quick Configuration

After successfully accessing the AWK, refer to the appropriate subsection below to quickly set up a wireless network.

NOTE Ensure that there are no IP address conflicts when you configure more than one AWK on the same subnet.

Point-to-Multipoint Scenario (AP/Client Mode)

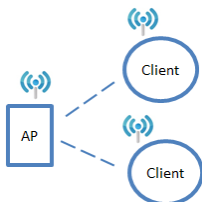

Configuring the AWK as an AP

- Step 1: Set the operation mode of the AWK to AP mode.**

Go to **Wireless LAN Setup** → **Operation Mode** and select AP.

Operation Mode

Wireless enable Enable Disable

Operation mode

NOTE The default operation mode for the AWK is AP.

- Step 2: Set up your own SSID.**

Go to **Wireless LAN Setup** → **WLAN** → **Basic WLAN Setup** and click **Edit** to set the SSID.

Basic WLAN Setup (Multiple SSID)

Status	SSID	Operation Mode	Action
Active	MOXA	AP	<input type="button" value="Edit"/>

Basic WLAN Setup

Operation mode AP

RF type B/G/N Mixed

Channel 6

Channel width 20 MHz

SSID MOXA

SSID broadcast Enable Disable

NOTE The default SSID is MOXA.

- **Step 3: Set the RF type and Channel for the AWK.**

Go to **Wireless LAN Setup** → **WLAN** → **Basic WLAN Setup**.

We recommend that you choose the RF type 5 GHz for a relative clean medium with minimum interference.

The screenshot shows the 'Basic WLAN Setup' form. The 'Operation mode' is set to 'AP'. The 'RF type' dropdown menu is open, showing options: B/G/N Mixed, 2.4GHz, B, G, B/G Mixed, G/N Mixed, B/G/N Mixed, N Only (2.4GHz), 5GHz, A, A/N Mixed, and N Only (5GHz). The 'Channel' dropdown menu is also open, showing options: 1, 6, 11, 16, 20, 24, 28, 32, 36, 40, 44, 48, 52, 56, 60, 64, 68, 72, 76, 80, 84, 88, 92, 96, 100, 104, 108, 112, 116, 120, 124, 128, 132, 136, 140, 144, 148, 152, 156, 160, 164, 168, 172, 176, 180, 184, 188, 192, 196, 200, 204, 208, 212, 216, 220, 224, 228, 232, 236, 240, 244, 248, 252, 256, 260, 264, 268, 272, 276, 280, 284, 288, 292, 296, 300, 304, 308, 312, 316, 320, 324, 328, 332, 336, 340, 344, 348, 352, 356, 360, 364, 368, 372, 376, 380, 384, 388, 392, 396, 400, 404, 408, 412, 416, 420, 424, 428, 432, 436, 440, 444, 448, 452, 456, 460, 464, 468, 472, 476, 480, 484, 488, 492, 496, 500, 504, 508, 512, 516, 520, 524, 528, 532, 536, 540, 544, 548, 552, 556, 560, 564, 568, 572, 576, 580, 584, 588, 592, 596, 600, 604, 608, 612, 616, 620, 624, 628, 632, 636, 640, 644, 648, 652, 656, 660, 664, 668, 672, 676, 680, 684, 688, 692, 696, 700, 704, 708, 712, 716, 720, 724, 728, 732, 736, 740, 744, 748, 752, 756, 760, 764, 768, 772, 776, 780, 784, 788, 792, 796, 800, 804, 808, 812, 816, 820, 824, 828, 832, 836, 840, 844, 848, 852, 856, 860, 864, 868, 872, 876, 880, 884, 888, 892, 896, 900, 904, 908, 912, 916, 920, 924, 928, 932, 936, 940, 944, 948, 952, 956, 960, 964, 968, 972, 976, 980, 984, 988, 992, 996, 1000. The '5GHz' and 'N Only (5GHz)' options are highlighted with a red box.

For the **Channel** setting, we recommend that you choose a channel other than the default channel to avoid interference.

The screenshot shows the 'Basic WLAN Setup' form. The 'Operation mode' is set to 'AP'. The 'RF type' is set to 'N Only (5GHz)'. The 'Channel' dropdown menu is open, showing options: 1, 6, 11, 16, 20, 24, 28, 32, 36, 40, 44, 48, 52, 56, 60, 64, 68, 72, 76, 80, 84, 88, 92, 96, 100, 104, 108, 112, 116, 120, 124, 128, 132, 136, 140, 144, 148, 152, 156, 160, 164, 168, 172, 176, 180, 184, 188, 192, 196, 200, 204, 208, 212, 216, 220, 224, 228, 232, 236, 240, 244, 248, 252, 256, 260, 264, 268, 272, 276, 280, 284, 288, 292, 296, 300, 304, 308, 312, 316, 320, 324, 328, 332, 336, 340, 344, 348, 352, 356, 360, 364, 368, 372, 376, 380, 384, 388, 392, 396, 400, 404, 408, 412, 416, 420, 424, 428, 432, 436, 440, 444, 448, 452, 456, 460, 464, 468, 472, 476, 480, 484, 488, 492, 496, 500, 504, 508, 512, 516, 520, 524, 528, 532, 536, 540, 544, 548, 552, 556, 560, 564, 568, 572, 576, 580, 584, 588, 592, 596, 600, 604, 608, 612, 616, 620, 624, 628, 632, 636, 640, 644, 648, 652, 656, 660, 664, 668, 672, 676, 680, 684, 688, 692, 696, 700, 704, 708, 712, 716, 720, 724, 728, 732, 736, 740, 744, 748, 752, 756, 760, 764, 768, 772, 776, 780, 784, 788, 792, 796, 800, 804, 808, 812, 816, 820, 824, 828, 832, 836, 840, 844, 848, 852, 856, 860, 864, 868, 872, 876, 880, 884, 888, 892, 896, 900, 904, 908, 912, 916, 920, 924, 928, 932, 936, 940, 944, 948, 952, 956, 960, 964, 968, 972, 976, 980, 984, 988, 992, 996, 1000. The '36' option is highlighted with a red box.

Click **Submit** to apply the changes, and restart the AWK in AP mode to complete the configuration process.

Configuring the AWK as a Client

- **Step 1: Set the operation mode of the AWK to Client mode.**

Go to **Wireless LAN Setup** → **Operation Mode**, set the operation mode to Client, and then click **Submit** to apply the change.

The screenshot shows the 'Operation Mode' form. The 'Wireless enable' option is checked. The 'Operation mode' dropdown menu is open, showing options: AP, AP, Client, Client-Router, Master, Slave, Sniffer. The 'Client' option is highlighted with a red box.

- **Step 2: Link to an existing SSID.**

Go to **Wireless LAN Setup** → **WLAN** → **Basic WLAN Setup** and click **Site Survey** to select an existing SSID, or directly enter an existing SSID in the text field.

The screenshot shows the 'Basic WLAN Setup' form. The 'Operation mode' is set to 'Client'. The 'RF type' is set to 'B/G/N Mixed'. The 'Channel width' is set to '20 MHz'. The 'SSID' text field contains 'MOXA'. The 'Site Survey' button is highlighted with a red box.

- **Step 3: Set the RF type and Channel settings for the AWK.**

On the **Wireless LAN Setup** → **WLAN** → **Basic WLAN Setup** page, edit the RF type and Channel settings.

Click **Submit** to apply the changes, and restart the AWK in client mode to complete the configuration process.

Point-to-Point Scenario (Master/slave mode)



Configuring the AWK as a Master

- **Step 1: Set the operation mode of the AWK to Master mode.**

Go to **Wireless LAN Setup** → **Operation Mode**, set the operation mode to **Master**, and then click **Submit** to apply the change.

- **Step 2: Set up your own SSID.**

Go to **Wireless LAN Setup** → **WLAN** → **Basic WLAN Setup** and click **Edit** to set the SSID.

- **Step 3: On the Wireless LAN Setup** → **WLAN** → **Basic WLAN Setup** page edit the RF type and Channel settings.

Click **Submit** to apply the changes, and restart the AWK in master mode to complete the configuration process.

Configuring the AWK as a Slave

- **Step 1: Set the operation mode of the AWK to Slave mode.**

Go to **Wireless LAN Setup** → **Operation Mode**, set the operation mode to **Slave**, and then click **Submit** to apply the change.

The screenshot shows a configuration interface for the AWK's operation mode. It includes a 'Wireless enable' section with radio buttons for 'Enable' (selected) and 'Disable'. Below this is the 'Operation mode' section with a dropdown menu. The dropdown menu is open, displaying a list of modes: 'Slave' (highlighted in blue), 'AP', 'Client', 'Client-Router', 'Master', and 'Sniffer'. A 'Submit' button is located at the bottom left of the form.

- **Step 2: Link to an existing SSID.**

Go to **Wireless LAN Setup** → **WLAN** → **Basic WLAN Setup** and click **Site Survey** to select an existing SSID, or directly enter an existing SSID in the text field.

- **Step 3: Set the RF type for the AWK.**

On the **Wireless LAN Setup** → **WLAN** → **Basic WLAN Setup** page edit the RF type setting.

Click **Submit** to apply the changes, and restart the AWK in slave mode to complete the configuration process.