

# OnCell G2111/G2151I Series User's Manual

---

**Edition 2.1, May 2017**

[www.moxa.com/product](http://www.moxa.com/product)

**MOXA<sup>®</sup>**

© 2017 Moxa Inc. All rights reserved.

# OnCell G2111/G2151I Series User's Manual

The software described in this manual is furnished under a license agreement and may be used only in accordance with the terms of that agreement.

## Copyright Notice

© 2017 Moxa Inc. All rights reserved.

## Trademarks

The MOXA logo is a registered trademark of Moxa Inc.  
All other trademarks or registered marks in this manual belong to their respective manufacturers.

## Disclaimer

Information in this document is subject to change without notice and does not represent a commitment on the part of Moxa.

Moxa provides this document as is, without warranty of any kind, either expressed or implied, including, but not limited to, its particular purpose. Moxa reserves the right to make improvements and/or changes to this manual, or to the products and/or the programs described in this manual, at any time.

Information provided in this manual is intended to be accurate and reliable. However, Moxa assumes no responsibility for its use, or for any infringements on the rights of third parties that may result from its use.

This product might include unintentional technical or typographical errors. Changes are periodically made to the information herein to correct such errors, and these changes are incorporated into new editions of the publication.

## Technical Support Contact Information

[www.moxa.com/support](http://www.moxa.com/support)

### **Moxa Americas**

Toll-free: 1-888-669-2872  
Tel: +1-714-528-6777  
Fax: +1-714-528-6778

### **Moxa Europe**

Tel: +49-89-3 70 03 99-0  
Fax: +49-89-3 70 03 99-99

### **Moxa India**

Tel: +91-80-4172-9088  
Fax: +91-80-4132-1045

### **Moxa China (Shanghai office)**

Toll-free: 800-820-5036  
Tel: +86-21-5258-9955  
Fax: +86-21-5258-5505

### **Moxa Asia-Pacific**

Tel: +886-2-8919-1230  
Fax: +886-2-8919-1231

# Table of Contents

<b>1. Introduction</b>	<b>1-1</b>
Overview	1-2
Package Checklist	1-2
Features	1-2
Specifications	1-3
Pin Assignments	1-4
<b>2. Getting Started</b>	<b>2-1</b>
Product Characteristics	2-2
Dimensions	2-2
Connecting the Hardware	2-2
Wiring Requirements	2-3
SIM Card Installation	2-3
DIN-Rail Mounting	2-4
Wall Mounting	2-5
Connecting the Antenna	2-6
Connecting to a Power Source	2-6
Connecting a Serial Device	2-7
LED Indicators	2-8
<b>3. AT Command Set</b>	<b>3-1</b>
AT Command Set Introduction	3-2
Starting Moxa Terminal Emulator	3-2
AT Command Examples	3-3
Modem Acknowledgement	3-4
Verify Signal Strength	3-4
PIN Code Management	3-5
Query the Current PIN Status	3-5
Disable the Facility Lock	3-6
Serial Line Settings	3-7
Modifying the Baudrate	3-7
Flow Control	3-8
2-wire RS-485 Communication (OnCell G2151I only)	3-9
Additional Information	3-10
<b>4. GSM/CSD Connection</b>	<b>4-1</b>
Overview	4-2
Initiating a CSD Connection	4-2
Answering a CSD Connection	4-3
<b>5. Using Short Message Services</b>	<b>5-1</b>
Sending Short Messages	5-2
Reading Short Messages	5-2
Deleting Short Messages	5-3
<b>6. GPRS Connection</b>	<b>6-1</b>
GPRS Overview	6-2
Windows GPRS Access	6-2
Installing the Modem Driver	6-3
Modem Diagnostics	6-5
Setting up the APN	6-7
Adding Windows DUN Entry	6-8
Internet Service Connection	6-14
<b>A. GPRS with the UC-7110 and UC-7112</b>	<b>A-1</b>
<b>B. Federal Communications Commission Interference Statement</b>	<b>B-1</b>

## Introduction

---

The OnCell G2111/G2151I Series of industrial GSM/GPRS modems provide an easy way to connect your remote RS-232, or RS-422/485 serial devices to GSM and GPRS mobile networks.

The following topics are covered in this chapter:

- **Overview**
- **Package Checklist**
- **Features**
- **Specifications**
- **Pin Assignments**

# Overview

The OnCell G2111/G2151I Series consists of quad-band GSM/GPRS modems that transmit data and short messages (SMS) over GSM/GPRS mobile networks. The modems do not require a high level of technical knowledge to operate and can be used to improve your communication efficiency and maintenance. All models provide standard RS-232 communication and 15 kV ESD serial line protection, ideal for attaching devices such as stand-alone controllers, PC COM ports, and multi-drop electric meters. The enclosure is IP30-rated and can be mounted on a DIN rail or on the wall. 12 to 48 VDC power input is supported to connect different types of field power sources. Status information is clearly provided through several LED indicators.

The OnCell G2111/G2151I Series includes the following models:

- OnCell G2111 industrial GSM/GPRS modem, RS-232
- OnCell G2111-T industrial GSM/GPRS modem, RS-232, wide operating temperature
- OnCell G2151I industrial GSM/GPRS modem, RS-232 and RS-422/485, 2.5 KV RMS isolation protection

# Package Checklist

## Product

- OnCell G2111/G2151I Series industrial GSM/GPRS modem

## Standard Accessories

- Document & software CD
- 0 dBi magnetic mount SMA antenna
- Terminal block adaptor for power jack connector.
- Quick installation guide (printed)
- Warranty card

**NOTE** Contact your sales representative if any of the above items are missing or damaged.

## Optional Accessories

- Power adaptor
- ANT-CQB-O-1: High-gain antenna, omni-directional, 1 dBi, SMA, rubber
- ANT-CQB-O-3-3m: High-gain antenna, 3 meters, 3 dBi/25 cm, magnetic mount, SMA
- ANT-CQB-O-5-3m: High-gain antenna, 3 meters, 5 dBi/37 cm, magnetic mount, SMA
- CBL-F9M9-150: Serial cable, 100 cm, DB9 (female) to DB9 (male), RS-232
- CBL-F9M9-20: Serial cable, 20 cm, DB9 (female) to DB9 (male), RS-232
- UPort 1110: USB-to-serial adaptor, RS-232

# Features

- Quad-band GSM/GPRS supporting 900/1800 MHz, 850/1900 MHz
- GPRS Class 10 supporting up to 14,400 bps in GSM CSD mode
- SMS (short message) support
- 15 KV ESD serial line protection
- LED indicators for signal status
- IP30 enclosure supporting DIN-rail and wall mounting
- RS-422/485 interface (OnCell G2151I only)
- 2.5 KV RMS for 1 minute isolation for all serial signals (OnCell G2151I only)

# Specifications

## Cellular Interface

**Standards:** GSM/GPRS

**Band Options:** Quad-band 850/900/1800/1900 MHz

**GPRS Multi-slot Class:** Class 10

**GPRS Terminal Device Class:** Class B

**GPRS Coding Schemes:** CS1 to CS4

**CSD Data Transmission Rate:** Up to 14,400 bps

**Tx Power:** 1 watt GSM1800/1900, 2 watts EGSM 900/GSM 850

## SIM Interface

**Number of SIMs:** 1

**SIM Control:** 3 V

## Serial Interface

**Number of Ports:** 1

**Serial Standards:**

G2111: RS-232 (DB9 female connector)

G2111-T: RS-232 (DB9 female connector)

G2151I: RS-232 (DB9 female connector), RS-422/485 (5-pin terminal block connector)

**ESD Protection:** 15 KV (G2111 only)

**Optical Isolation:** 2.5 KV (G2151I only)

## Serial Communication Parameters

**Data Bits:** 8

**Stop Bits:** 1

**Parity:** None

**Flow Control:** RTS/CTS

**Baudrate:** 300 bps to 230.4 Kbps

## Serial Signals

**RS-232:** TxD, RxD, RTS, CTS, DTR, DSR, DCD, RI, GND

**RS-422:** Tx+, Tx-, Rx+, Rx-, GND

**RS-485-4w:** Tx+, Tx-, Rx+, Rx-, GND

**RS-485-2w:** Data+, Data-, GND

## Physical Characteristics

**Housing:** ABS + PC, IP30 protected

**Weight:** 150 ± 5 g

**Dimensions:** 27 x 123 x 79 mm (1.06 x 4.84 x 3.11 in)

## Environmental Limits

**Operating Temperature:**

OnCell G2111/G2151I: -20 to 55°C (-4 to 131°F)

OnCell G2111-T: -25 to 70°C (-13 to 158°F)

**Storage Temperature:** -40 to 75°C (-40 to 167°F)

**Ambient Relative Humidity:** 5 to 95% (30°C, non-condensing)

## Power Requirements

**Input Voltage:** 12 to 48 VDC

**Power Consumption:** 12 to 48 VDC, 900 mA (max.)

## Standards and Certifications

**UL**

**EMC:** EN 55032 Class A, EN 55024, FCC Part 15 Subpart B Class A

**Radio:** FCC Part 22H, FCC Part 24E, EN 301 489-1, EN 301 489-7, EN 301 511

**Reliability**

**MTBF (mean time between failures):**

OnCell G2111/G2111-T: 925,000 hrs

OnCell G2151I: 864,000 hrs

**Warranty**

**Warranty Period:** 5 years

**Details:** See [www.moxa.com/warranty](http://www.moxa.com/warranty)

## Pin Assignments

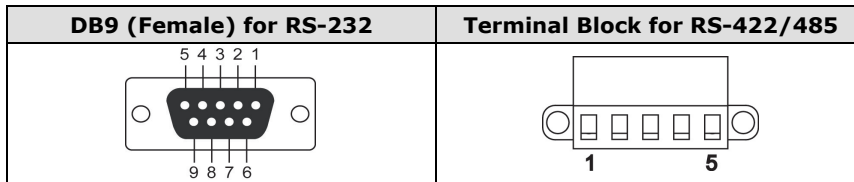

Pin	RS-232	RS-422*	RS-485-4W*	RS-485-2W*
1	DCD	TxD+	TxD+	-
2	TxD	TxD-	TxD-	-
3	RxD	RxD+	RxD+	Data + (B)
4	DSR	RxD-	RxD-	Data - (A)
5	GND	-	-	-
6	DTR	-	-	-
7	CTS	-	-	-
8	RTS	-	-	-

\*The terminal block for RS-422 and RS-485 is only available with the OnCell G2151I.

## Getting Started

---

This chapter includes instructions on how to install the OnCell G2111/G2151I Series modem.

The following topics are covered in this chapter:

- ❑ **Product Characteristics**
- ❑ **Dimensions**
- ❑ **Connecting the Hardware**
  - Wiring Requirements
  - SIM Card Installation
  - DIN-Rail Mounting
  - Wall Mounting
  - Connecting the Antenna
  - Connecting to a Power Source
  - Connecting a Serial Device
  - LED Indicators



# Product Characteristics



# Dimensions

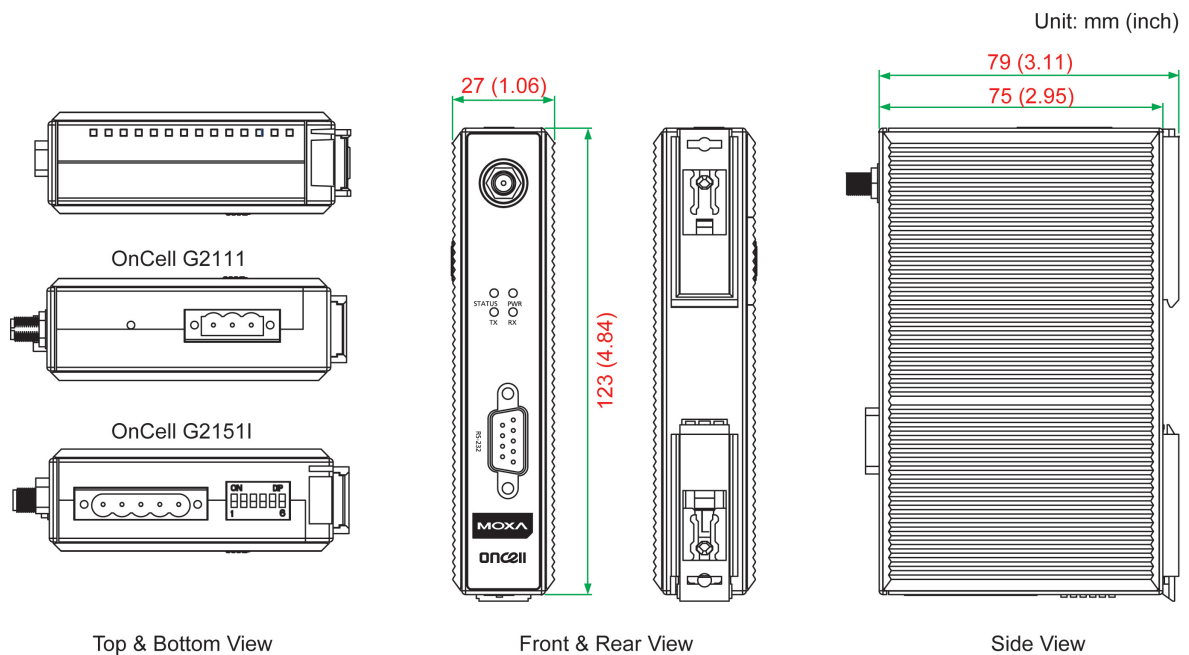

# Connecting the Hardware

This section describes how to connect the OnCell G2111/G2151I Series modem to a host PC or serial devices for initial testing and configuration.

## Wiring Requirements



### ATTENTION

#### Safety First!

Be sure to disconnect the power cord before installing and/or wiring your device.

#### Wiring Caution!

Calculate the maximum possible current in each power wire and common wire. Observe all electrical codes dictating the maximum current allowable for each wire size. If the current goes above the maximum ratings, the wiring could overheat, causing serious damage to your equipment.

#### Temperature Caution!

Be careful when handling the device. When plugged in, the device's internal components generate heat and the casing may feel hot to the touch.

You should also pay attention to the following guidelines:

- Use separate paths to route wiring for power and devices. If power wiring and device wiring paths must cross, make sure the wires are perpendicular at the intersection point.

**NOTE:** Do not run signal or communication wiring and power wiring in the same wire conduit. To avoid interference, wires with different signal characteristics should be routed separately.

- Use the type of signal transmitted through a wire to determine which wires should be kept separate. Generally, if different wires share similar electrical characteristics, they can be bundled together.
- Keep input wiring and output wiring separate.
- If possible, it is recommended that all device wiring be clearly labeled.

## SIM Card Installation

In order to protect the SIM card, the SIM card slot is located inside the casing. You will need to unscrew and remove the outer cover before installing or removing the SIM card.

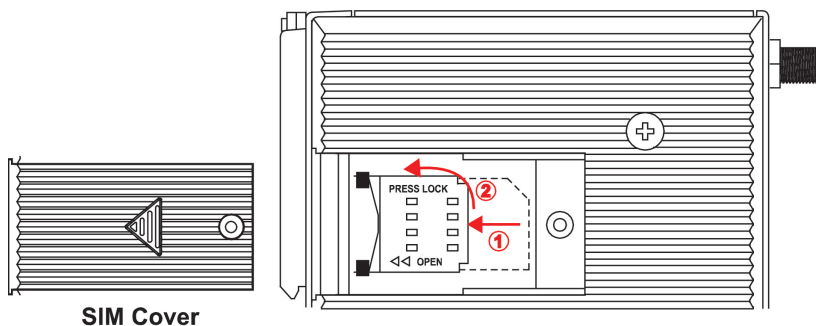

Follow these steps to remove or install the SIM card:

1. Unscrew the outer cover.
2. Slide the outer cover to the left to remove it.
3. Slide the SIM card cradle to the left and pull it towards you. Insert the SIM card into the cradle.
4. Swing the cradle back against the unit and slide it back into place. Replace the outer SIM card cover.

## DIN-Rail Mounting

Built-in mounting appendages allow the modem to be mounted to a flat wall or on a DIN rail. Follow the instructions below to mount the modem on a DIN rail.



### ATTENTION

Before mounting the OnCell G2111/G2151I Series modem, we strongly recommend that you first remove the antenna connection.

**STEP 1:** Use a flat-blade screw driver to pull the bottom mounting appendage out. It should snap into place.

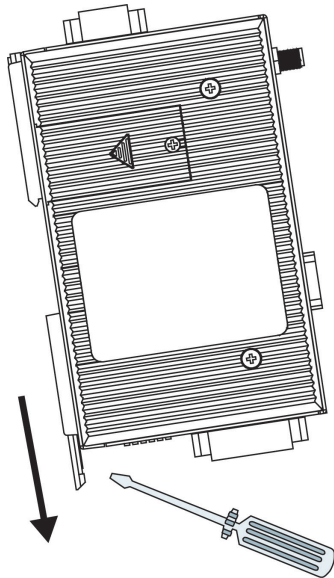

**STEP 2:** Hook the modem over the top edge of the DIN rail as shown.

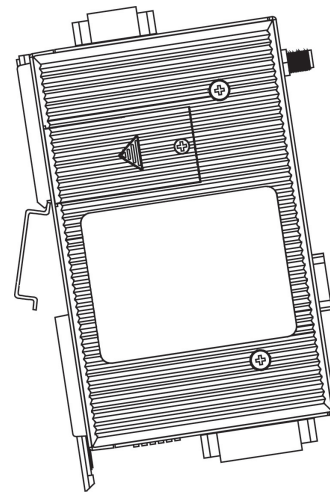

**STEP 3:** Place the modem flush against the DIN rail as shown.

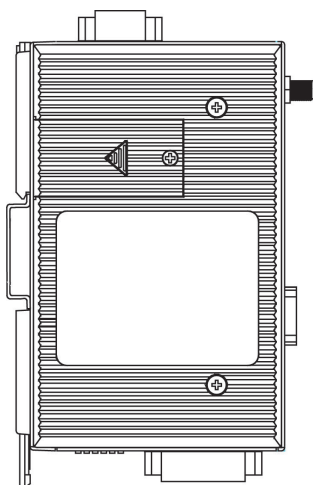

**STEP 4:** Slide the bottom mounting appendage back in. It should snap into place over the bottom edge of the DIN rail.

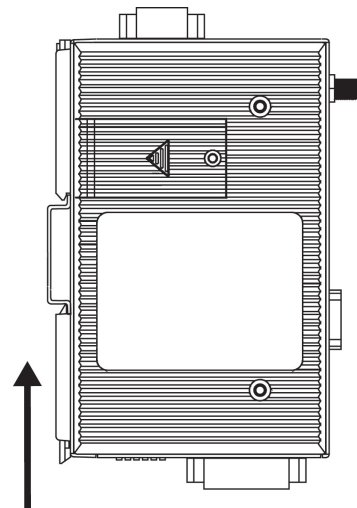



**ATTENTION**

Grounding and wire routing help limit the effects of noise due to electromagnetic interference (EMI). There are two grounding points for the unit. One point is the 3-pin terminal block connector for power. Underneath the bottom mounting appendage is another grounding point.

For DIN-rail mountable units: Ground the DIN rail itself. The modem's grounding point under the mounting appendage will be in direct contact with the rail. Be sure to ground the DIN rail before connecting the modem to the DIN rail.

For wall or panel-mounted units: Run a ground wire from the right-most pin of the terminal block connector. Be sure to connect the ground wire before connecting devices to the modem.

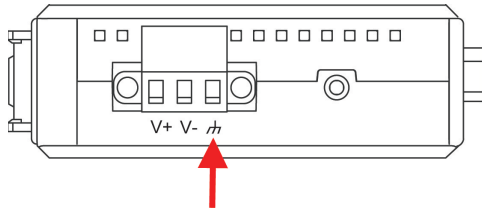

**Wall Mounting**

Follow the instructions below to mount the OnCell Series modem on a wall:

**STEP 1:** Remove the 3-pin power terminal block. For the OnCell G2151I, also remove the 5-pin RS-422/485 terminal block.

**STEP 2:** Use a flat-blade screw driver to pull out both the top and bottom mounting appendages.

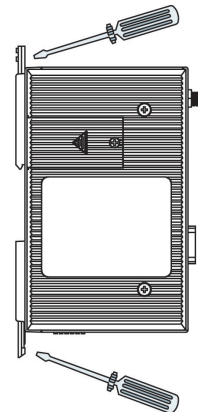
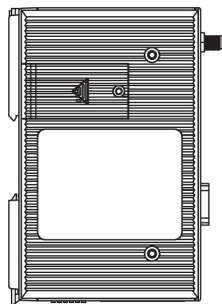

**STEP 3:** Use screws and the mounting appendages to mount the unit onto the wall.

**STEP 4:** Reattach the terminal block(s) to the modem.

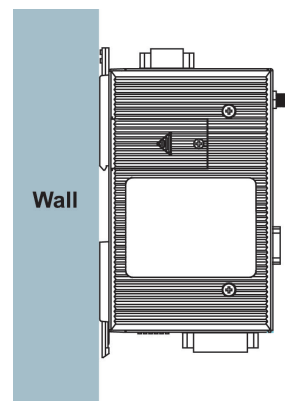
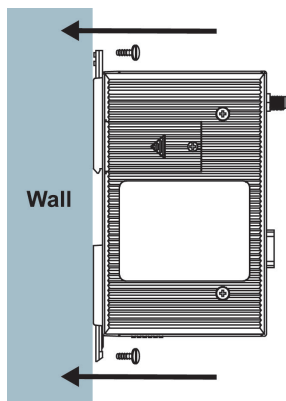

## Connecting the Antenna



### ATTENTION

Make sure the transmitter antenna is placed so that it is at least 20 cm (8 inches) away from any people or users. The modem is not designed for applications where users will be in close proximity for prolonged periods. Turn the unit off for the following situations:

- When in an aircraft
- When around gasoline or diesel-fuel pumps and before filling your vehicle with fuel
- When in hospitals and any other place where medical equipment may be in use

Respect any restrictions on the use of radio equipment, especially around fuel depots, chemical plants, and blasting operations.

The OnCell G2111/G2151I Series modem may present a hazard for inadequately protected personal medical devices such as hearing aids and pacemakers. Consult the manufacturer of the medical device to determine if it is adequately protected.

The OnCell G2111/G2151I Series modem may cause interference for inadequately protected electronic equipment. Observe any warning signs and manufacturers' recommendations.

All OnCell G2111/G2151I Series modems are shipped with a 0 dBi antenna with SMA connector and magnetic mount. The 3-meter patch cord is ideal for installing the modem in places such as a metal cabinet or a vending machine.

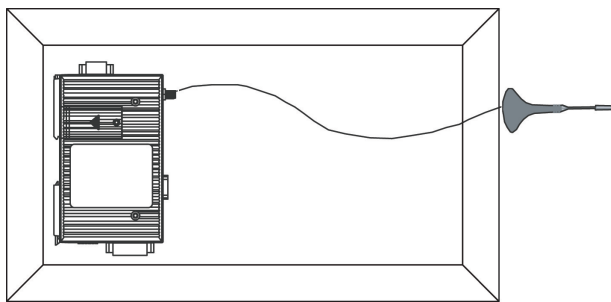

## Connecting to a Power Source

The power connector is a 3-pin terminal block. It can connect to different types of field power sources that support 12 to 48 VDC. When power is connected, the "PWR" LED will light up. It will glow a steady green when the system is ready.

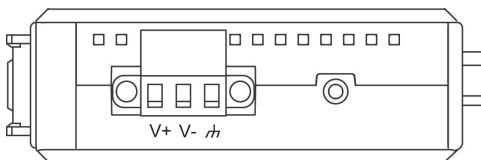

A terminal block adaptor with power jack connector is provided to connect to AC power instead of DC power. Compatible AC power adaptors are listed on the Moxa website, [www.moxa.com](http://www.moxa.com).



### ATTENTION

Always install the antenna first and then connect power. Do not connect power if the antenna has not been installed! Doing so may damage the unit.

## Connecting a Serial Device

The RS-232 serial interface come with 15 kV ESD serial line protection and matches the pinouts of a standard D-shell connector. A serial device or PC COM port can be connected with a DB9(M) to DB9(F) serial cable, such as Moxa’s CBL-F9M9-150 (100 cm) or CBL-F9M9-20 (20 cm).

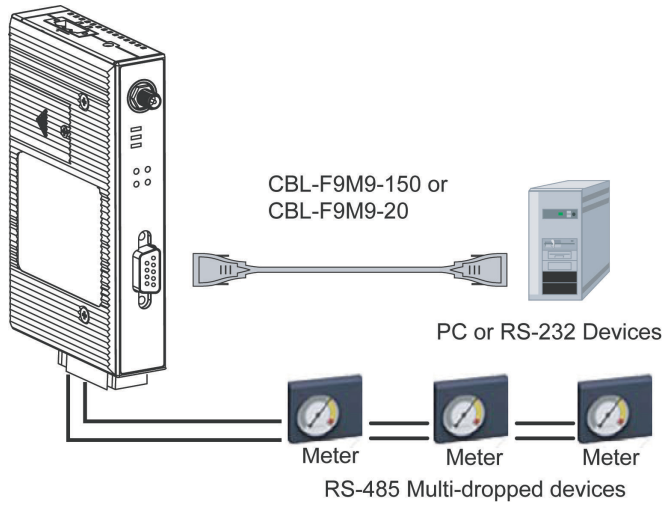

### For OnCell G2151I Only

A separate 5-pin terminal block connector on the bottom panel is used for RS-422, 2-wire RS-485, and 4-wire RS-485 connections. A built-in 120 Ω terminal resistor can be activated by DIP switch if required. Pull high/low resistor adjustments are also allowed. Both the RS-232 and RS-422/485 interfaces come with two types of protection: (1) 2.5 kV RMS isolation for 1 min and (2) 15 kV ESD serial line protection.

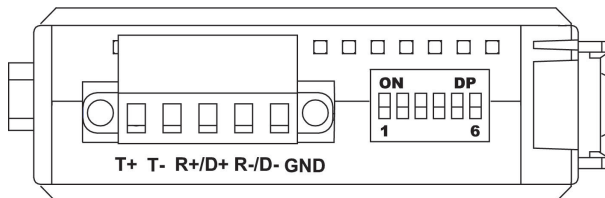

RS-422/485 settings are configured by DIP switch, on the bottom panel.

- Switches 1, 2, and 3 select the serial interface.
- Switch 4 enables or disables the termination resistor.
- Switches 5 and 6 set the pull high/low resistor.



Serial Interface	SW1	SW2	SW3
RS-232	ON	OFF	OFF
RS-422	OFF	OFF	OFF
4W RS-485	OFF	ON	OFF
2W RS-485	OFF	ON	ON

Termination Resistor	SW4
Enabled	ON
Disabled	OFF

Pull High/Low Resistor	SW5	SW6
1 KΩ	ON	ON
150 KΩ	OFF	OFF

## LED Indicators

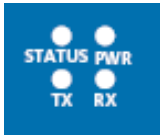

Name	Color	Function
PWR	Green	DC power connection
STATUS	Amber	Steady Blinking: No SIM card present or PIN entered incorrectly. Slow Blinking: Modem registered on GSM network. Fast Blinking: Modem connected to GPRS. Always On: Modem connected in CSD mode.
TX	Amber	Serial Tx
RX	Green	Serial Rx

## AT Command Set

---

The AT Command Set can be used to operate, configure, and query the OnCell G2111/G2151I Series modem. This chapter includes information about the AT Command Set of the OnCell G2111/G2151I Series modem.

The following topics are covered in this chapter:

- ❑ **AT Command Set Introduction**
- ❑ **Starting Moxa Terminal Emulator**
- ❑ **AT Command Examples**
  - Modem Acknowledgement
  - Verify Signal Strength
- ❑ **PIN Code Management**
  - Query the Current PIN Status
  - Disable the Facility Lock
- ❑ **Serial Line Settings**
  - Modifying the Baudrate
  - Flow Control
- ❑ **2-wire RS-485 Communication (OnCell G2151I only)**
- ❑ **Additional Information**



# AT Command Set Introduction

The OnCell G2111/G2151I Series modem supports the V.25ter AT command set. The "AT" prefix (also known as the Attention Code) signals the modem that one or more commands are to follow. The AT command set is an industry-standard language that is used to communicate with modems. The OnCell G2111/G2151I Series modem is always either in command mode or in on-line mode. When first powered up, the modem will enter command mode. The modem will only accept commands when it is in command mode. Commands that are received when the modem is in on-line mode are treated as data, not as commands. Commands may be entered from terminal software such as Windows HyperTerminal, or Moxa PComm Lite Terminal Emulator.

Settings made with AT commands are automatically reused by the modem until another command is received to change the settings, or the modem is turned off.

All but two of the commands must begin with the characters AT. The two exceptions are the escape sequence (+++), and the repeat command (A/). The command line prefix (letters AT) and the command sequences that follow can be entered in upper case or lower case, but the cases must not be mixed. More than one command can be typed on one line, and commands can be separated by spaces to make them easier to read. The spaces are ignored by the modem's command interpreter. The command line buffer accepts up to 39 characters including, "A" and "T". Spaces, carriage returns, and line feed characters are not placed in the buffer and do not count towards the 39-character limit. If more than 39 characters are entered, or if a syntax error is encountered in the command sequence, the modem returns an ERROR result code, and the command input is ignored.

The modem will acknowledge most commands almost immediately. As soon as you type in a command ending with the carriage return character, your modem will respond with OK.



## ATTENTION

+++

This is one of the two commands that do not use the AT prefix. The 3 "plus" signs are used for the Escape Character Sequence. After you have connected to another modem, you may need to return to command mode to modify the modem's configuration or to hang up. To do this, leave your keyboard idle (do not press any keys) for at least one second, and then press "+" three times. You do not need to press the Enter key. After a moment, the modem will respond with OK, indicating that Command mode is now active.

## Starting Moxa Terminal Emulator

The following instructions explain how to install the Moxa PComm Lite Package. After installing PComm Lite, you can use the built-in Moxa Terminal Emulator to handle your modem operations.



## ATTENTION

OnCell Terminal Emulator is designed for Windows 2000, XP, 2003, and Vista. If you are running Windows 98, ME, or NT, use PComm Lite V2.6, which can be downloaded on the Moxa website.

1. Start Terminal Emulator from the Windows Start menu.

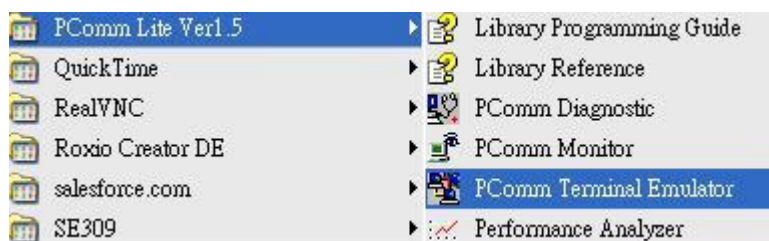

- The PComm Terminal Emulator user interface will appear. Click the **Open** button, which is the first blue icon on the tool bar.

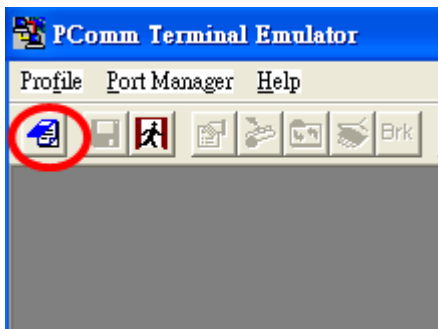

- Select the target COM port and communication parameters. Click **OK** to open the port.

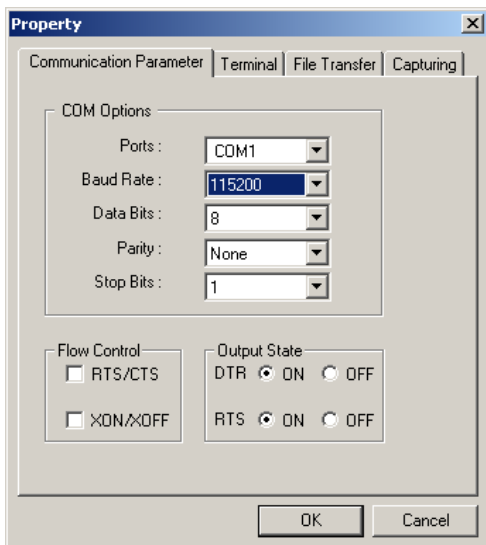

- Terminal Emulator will connect to the target COM port.

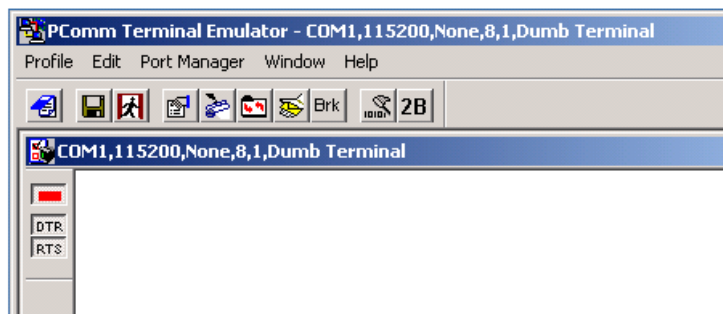

## AT Command Examples

The following examples can give users a better understanding of how to use the AT Commands.



### ATTENTION

Make sure that the RS-232 port of the OnCell G2111/G2151I Series modem is connected. For the OnCell G2151I, make sure DIP switch 1 is set to ON.

## Modem Acknowledgement

Connect the RS-232 port of the OnCell G2111/G2151I Series modem to a host PC. Start PComm Terminal Emulator with the current communication parameters. Type **AT** and press **Enter**. A modem response of **OK** indicates that the modem is ready.

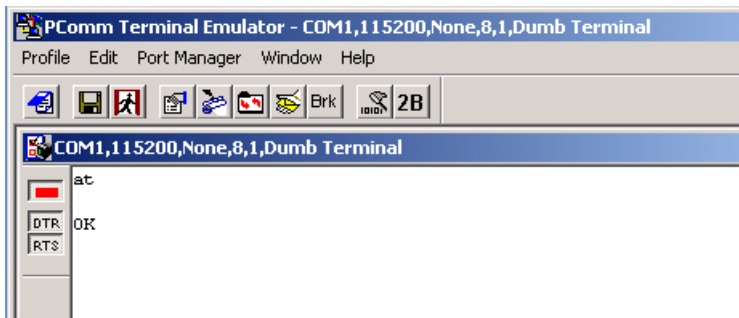

**NOTE** In a new device, the baudrate is set to a default of **Autobaud** mode, which allows the device to automatically negotiate the baudrate. For details on **Autobaud** mode settings and restrictions, refer to the *OnCell G2111/G2151I AT Command Set* manual.

## Verify Signal Strength

Connect the RS-232 port of the OnCell G2111/G2151I Series modem to a host PC. Open PComm Terminal Emulator with the current communication parameters. Type **AT+CSQ** and press **Enter**. The modem will respond with the receive signal strength (RSSI) and channel bit error rate (BER).

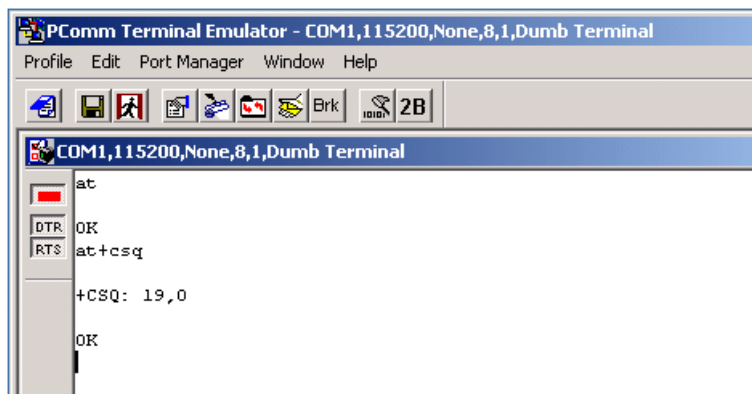

Signal Strength Verification	
0 to 12	Weak or insufficient
13 to 19	Average
20 to 31	Exceptional
99	No signal

BER ranges from 0 to 7, with 7 corresponding to a higher error rate.



### ATTENTION

RSSI should be higher than 12 if you wish to create or accept GSM/CSD data calls or establish a GPRS connection. If the RSSI is less than 12, you will only be able to transmit and receive SMS (short message). To check the bit error rate there must be a call in progress to obtain realistic values. If no call is set up, there is no BER to be determined. In this case the indicated value may be 0 or 99, depending on the SIM card.

# PIN Code Management

Operation of the OnCell G2111/G2151I Series modem requires the installation of an active SIM (Subscriber Identity Module) card. The SIM card contains the necessary data to identify the modem to the network service provider. It is also used to store the GSM/GPRS modem PIN (Personal Identification Number.) and PUK (Personal Unblocking Key), which are also used with mobile phones. The PIN helps prevent unauthorized persons from using the mobile devices. Users must enter the PIN each time the modem is powered up. The PUK is used to unlock a SIM card when an incorrect PIN code has been entered three times.

## Query the Current PIN Status

Connect the RS-232 port of the OnCell G2111/G2151I Series modem to a host PC. Start PComm Terminal Emulator with the current communication parameters.

1. Type **AT+CPIN?** and press **Enter**.

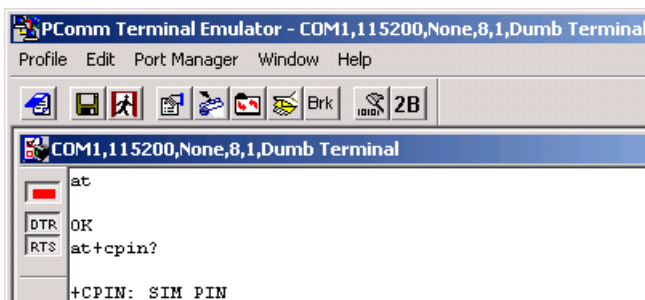

If the OnCell G2111/G2151I Series modem responds with "+CPIN: SIM PIN" then the user must enter the SIM's PIN code.

AT+CPIN? responses	
+CPIN: READY	Modem is not pending for any password
+CPIN: SIM PIN	PIN1 is required
+CPIN: SIM PUK	PUK1 is required

If the OnCell G2111/G2151I Series modem responds with "+CPIN: READY" then the SIM security is disabled, or the PIN for the SIM was entered correctly.

2. If the modem responds with **+CPIN: SIM PIN**, type **AT+CPIN=<pin>** where **<pin>** is the correct **PIN**. Press **Enter**. The following example shows "0000" being entered for the PIN.

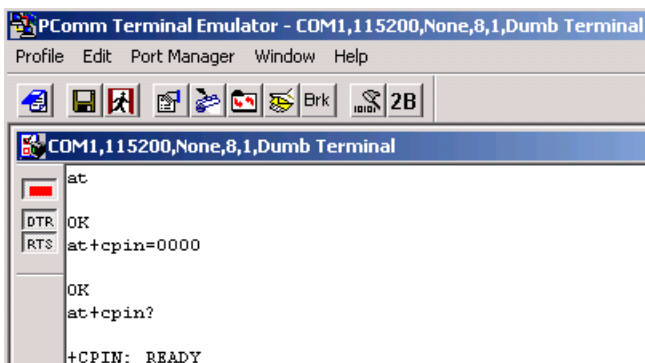



## ATTENTION

Be careful when entering the PIN codes.

After 3 unsuccessful attempts at entering the PIN, you will need to use the PUK to proceed. PUK validation forces the user to enter a new PIN code as a second parameter, and this will be the new PIN code if PUK validation succeeds. CHV1 will be enabled if PUK1 is correct. Therefore, the application uses the following command:

**AT+CPIN=<PUK>,<NewPIN>**

Note that users must apply for PUK codes from the mobile service provider.

## Disable the Facility Lock

Disabling the facility lock will allow the OnCell G2111/G2151I Series modem to operate without entering the PIN code each time the modem is powered up.

Type **AT+CPIN=<pin>** where *<pin>* is the correct PIN. Press **Enter**.

Type **AT+CLCK="SC",0,<pin>** where SC should be capitals and *<pin>* is the correct PIN. The following example shows "0000" being entered for the PIN:

```

PComm Terminal Emulator - COM1,115200,None,8,1,Dumb Terminal
Profile Edit Port Manager Window Help
[at]
DTR OK
RTS at+cpin?
+CPIN: SIM PIN
at+cpin=0000
OK
at+clck="SC",0,0000
OK

```

To enable the facility lock, type **AT+CLCK="SC",1,<pin>**

The following example shows "0000" being used for the PIN.

```

PComm Terminal Emulator - COM1,115200,None,8,1,Dumb Terminal
Profile Edit Port Manager Window Help
[at]
DTR OK
RTS at+clck="SC",1,0000
OK

```

**ATTENTION**

Once the correct PIN is entered, the system will activate the **Automatic PIN Entry** function. This function will store the current PIN in its memory and enter it into the OnCell G2111/G2151I Series modem each time the system boots up. If the SIM card does not match the current PIN, the **Automatic PIN Entry** function will be deactivated.

To activate the **Automatic PIN Entry** function again, use the **AT+ CPIN** command or OnCell Configurator to enter the correct PIN.

To disable **Automatic PIN Entry** once and for all, use the **AT\*USEPIN=0** command.

## Serial Line Settings

**ATTENTION**

Changes to the serial communication parameters take effect immediately. You will need to update your terminal settings to match any changes in the serial communication parameters.

Configuration can also be performed with the **AT\*SERIAL** command or OnCell Configurator.

Before changing the settings, first connect the RS-232 port of the OnCell G2111/G2151I Series modem to a host PC. Open PComm Terminal Emulator with the current communication parameters.

## Modifying the Baudrate

1. Type **AT+IPR=x** and press Enter, where x corresponds to one of the following baudrates: 300, 600, 1200, 2400, 4800, 9600, 14400, 19200, 28800, 38400, 57600, 115200, 230400, 0 (autobaud). For example, type **AT+IPR=9600** to change the baudrate to 9600 bps:

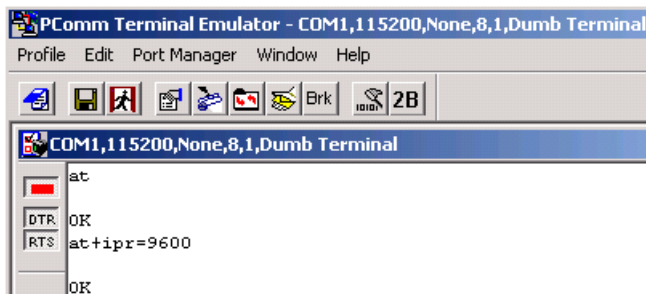

2. Modify the terminal settings to match the new serial communication parameters.

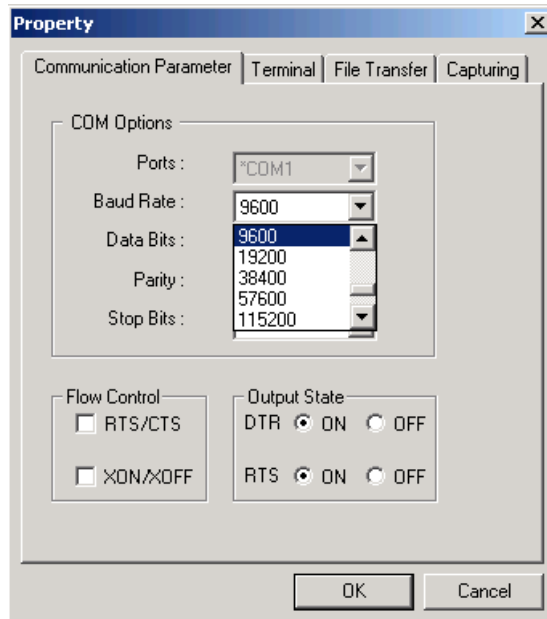

3. Type **AT&W** and press **Enter** to save the settings.

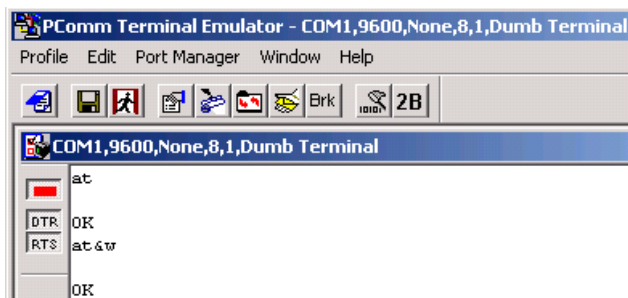

## Flow Control

The default RTS/CTS and XON/XOFF flow control setting is none. To enable RTS/CTS flow control:

1. Type **AT/Q=3** and press **Enter**. To disable flow control again, type **AT+ICF=0** and press **Enter**.

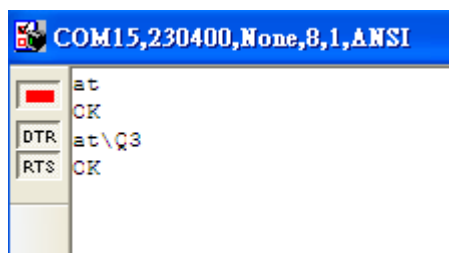

2. Type **AT&W** and press **Enter** to save the settings.
3. To enable XON/XOFF flow control:  
Type **AT/Q=1** and press **Enter**. To disable flow control again, type **AT+ICF=0** and press **Enter**.

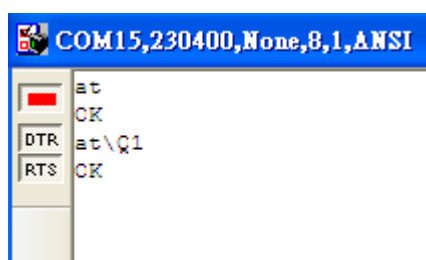

4. Type AT&W and press **Enter** to save the settings.

**ATTENTION**

Changes to the serial communication parameters take effect immediately. You will need to update your terminal settings to match any changes in the serial communication parameters. When using XON/XOFF flow control (AT\Q1) in online mode, +++ should not be used while the data transmission is paused with XOFF. Before entering the command mode with +++ the paused transmission should be resumed using the XON character.

## 2-wire RS-485 Communication (OnCell G2151I only)

2-wire RS-485 is half-duplex communication. For this reason, the modem's local echo should be disabled. Follow these steps to disable local echo:

**ATTENTION**

The local echo function can also be disabled using OnCell Configurator.

1. On the bottom of the modem, set DIP switch 1 to **ON**.
2. Connect the modem's RS-232 port to a host PC. Start PComm Terminal Emulator with the current communication parameters.
3. Type **ATE0** and press **Enter** to disable the local echo.
4. Type **AT&W** and press **Enter** to save the settings. Note that because the local echo is disabled, users will not see a response from the modem at the terminal screen.

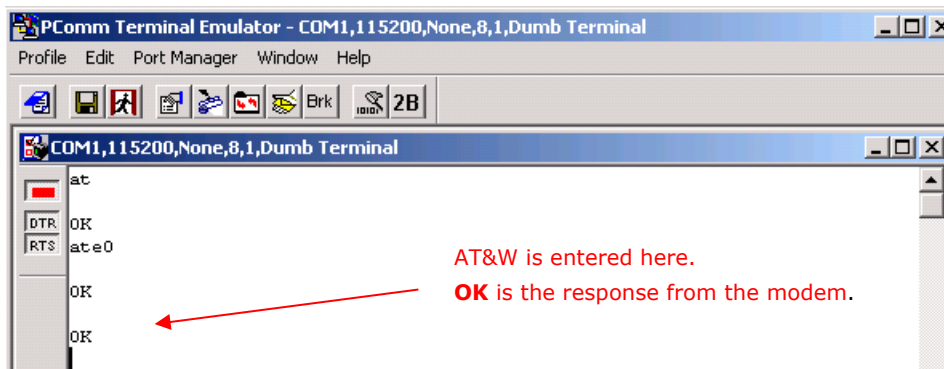

5. On the bottom of the modem, set DIP switch 1 to **OFF**, DIP switch 2 to **ON**, and DIP switch 3 to **ON**. This configures the modem for 2-wire RS-485 communication.



## Additional Information

- **V.25ter recommendation**  
For commands that are not supported, the OnCell G2111/G2151I Series modem will respond with "ERROR". Modulation control, error control, and data compression commands are not recognized. An "ERROR" string will be returned.
- **GSM 07.05 recommendation**  
07.05 commands that are not described in this manual will not be implemented. An "ERROR" string will be returned.
- **GSM 07.07 recommendation**  
07.07 commands that are not described in this manual will not be implemented. An "ERROR" string will be returned.
- The **ATQ1** command for "Result Code Suppression – not transmitted" is not supported.

## GSM/CSD Connection

---

A Circuit-Switched Data Connection makes the wireless modem work in a manner similar to a regular analog modem. You must have CSD service in order to make a CSD call.

The following topics are covered in this chapter:

- ❑ **Overview**
- ❑ **Initiating a CSD Connection**
- ❑ **Answering a CSD Connection**

## Overview

CSD (Circuit Switched Data) is the original form of data transmission developed for GSM systems. By using a single radio time slot, CSD is able to deliver 9.6 to 14.4 kbps data transmission to both the GSM network and PSTN switching subsystem through direct calls. Most of the time, it is initiated by standard AT commands. Using the modem to access remote devices by CSD is often more convenient than installing cables and data lines. Data collection and monitoring will be more flexible since CSD can be used for applications that are hard to wire or hard to access.

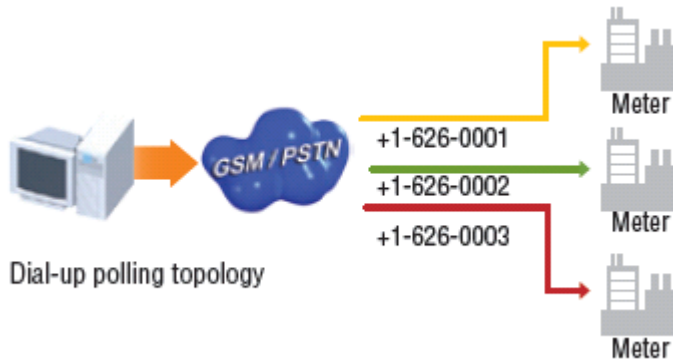

## Initiating a CSD Connection

A CSD connection can be initiated using the OnCell G2101 Series modem and PComm Terminal Emulator.

1. Start PComm Terminal Emulator with the current communication parameters.

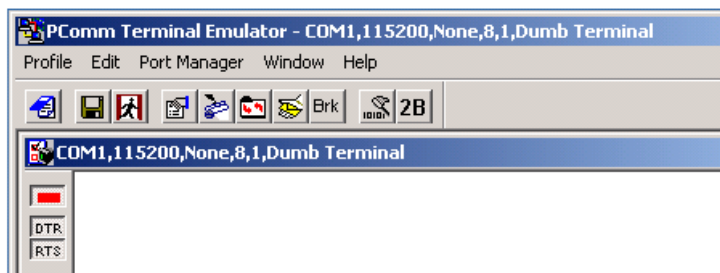

### ATTENTION

Use the AT command `AT+CSQ` to check the current signal strength value (refer to the OnCell G2101 AT command list in section 8.5).

If no signal is detected (RSSI return value = 99), then the SIM card is not installed properly, or there is no signal present. If the signal strength is not strong enough to create a CSD connection (RSSI return value < 12), adjust the position of the antenna, change the location of the modem, or use an optional high-gain antenna. Verify that your SIM card has CSD service activated. For most regions, you must apply with your mobile service provider to receive this service.

Verify that the RS-232 port on the OnCell G2111/G2151I Series modem is connected. For the OnCell G2151I, verify that DIP switch 1 is set to ON.

2. Type **ATD** <phone number> and press **Enter**. For example, type **ATD 0289191230** if the phone number is 0289191230.
3. Check the STATUS indicator on the front panel of the modem. If the LED is steadily on, the CSD connection has been established successfully.
4. To close the CSD connection, type **+++**. The modem will respond with **OK** to indicate that you have already switched back to the command mode.

5. Type **ATH** and press **Enter** to disconnect.

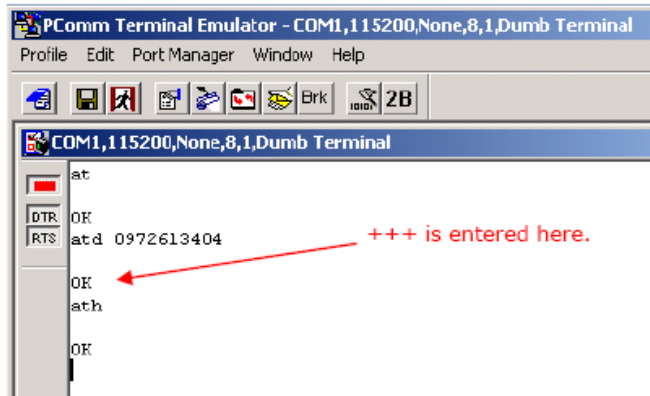

The screenshot shows the PCOMM Terminal Emulator window. The title bar reads "PCOMM Terminal Emulator - COM1,115200,None,8,1,Dumb Terminal". The menu bar includes "Profile", "Edit", "Port Manager", "Window", and "Help". The toolbar contains various icons including a printer, save, and a speed dial set to "2B". The terminal window shows the following text:

```

at
DTR: OK
RTS: atd 0972613404
OK
ath
OK
  
```

A red arrow points from the text "+++ is entered here." to the "OK" line following the "atd" command.



### ATTENTION

+++ is the escape sequence, and ATH is the hang-up command.

For international calls, the local international prefix does not required, but the + character is. You would type ATD+886289191230.

## Answering a CSD Connection

PCOMM Terminal Emulator can be used to answer a CSD call manually:

1. When the terminal displays "RING", type **ATA** and press **Enter**.

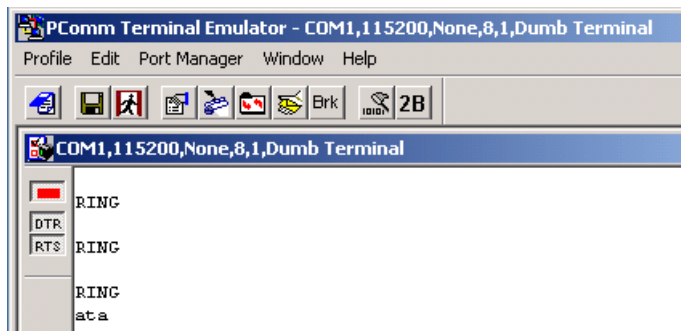

The screenshot shows the PCOMM Terminal Emulator window. The title bar reads "PCOMM Terminal Emulator - COM1,115200,None,8,1,Dumb Terminal". The menu bar includes "Profile", "Edit", "Port Manager", "Window", and "Help". The toolbar contains various icons including a printer, save, and a speed dial set to "2B". The terminal window shows the following text:

```

RING
DTR: RING
RTS: RING
RING
ata
  
```

2. Check the STATUS indicator on the front panel. If the LED is steadily on, the CSD connection has been established successfully. The modem will automatically switch to data mode. At this point, you can proceed with data communication.
3. PCOMM Terminal Emulator can be used to configure the modem to answer CSD calls automatically:
4. In the terminal window, type **ATS0=x** and press **Enter**. For **x**, substitute the number of rings that the modem should receive before answering the call. For example, to answer after the first ring, type **ATS0=1**.
5. Type **AT&W** and press **Enter**.

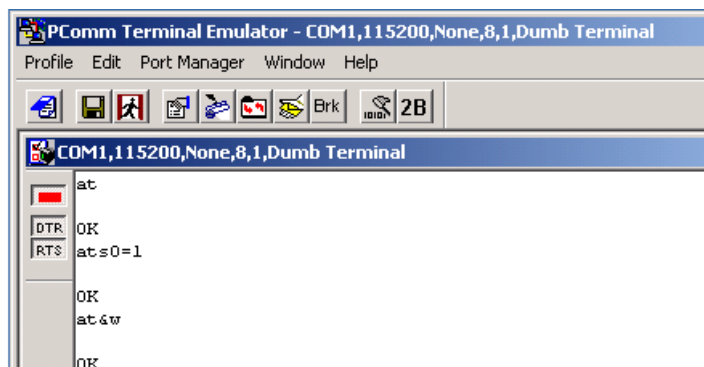

The screenshot shows the PCOMM Terminal Emulator window. The title bar reads "PCOMM Terminal Emulator - COM1,115200,None,8,1,Dumb Terminal". The menu bar includes "Profile", "Edit", "Port Manager", "Window", and "Help". The toolbar contains various icons including a printer, save, and a speed dial set to "2B". The terminal window shows the following text:

```

at
DTR: OK
RTS: ats0=1
OK
at&w
OK
  
```

6. To disconnect the modem, type **+++**. The modem will respond with **OK**, which means that you have already switched back to command mode. Type **ATH** and press **Enter** to disconnect.

**ATTENTION**

If you are answering a call from a PSTN dial-up modem, type `AT+CICB=0` to force the incoming call to be a data call. Type `AT+CBST=7, 0, 1` to select bearer type to V.32 modem (9600 bps). In addition, type `AT&W` to save the settings. For further information, refer to the *OnCell G2111/G2151I AT Command Set* manual. on Moxa's website.

## Using Short Message Services

---

GSM technology offers the benefit of using SMS (short message service) as an easy way to communicate over the mobile network. In this chapter, we explain how to use SMS with the OnCell G2101 Series modem.

The following topics are covered in this chapter:

- ❑ **Sending Short Messages**
- ❑ **Reading Short Messages**
- ❑ **Deleting Short Messages**

## Sending Short Messages

Follow these instructions to send a short message to a specific phone number.

1. Type **AT+CMGF=1** and press **Enter**.
2. Type **AT+CMGS="<phone number>"** and press **Enter**. The terminal will present a ">" prompt. Enter your message at the prompt.
3. Press **Ctrl + Z** to deliver the message.

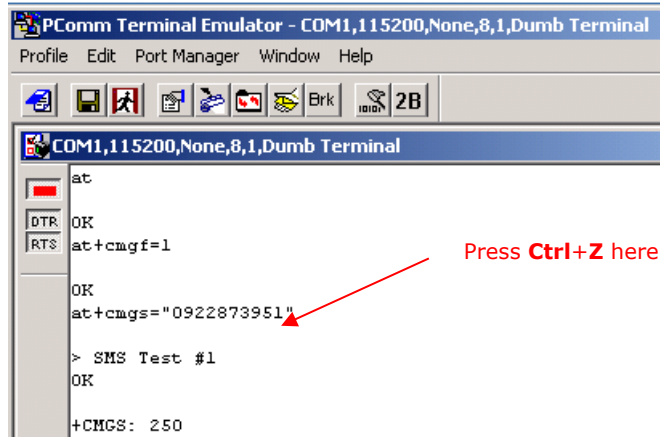

```

PCComm Terminal Emulator - COM1,115200,None,8,1,Dumb Terminal
Profile Edit Port Manager Window Help
COM1,115200,None,8,1,Dumb Terminal
at
DTR OK
RTS at+cmgf=1
OK
at+cmgs="0922873951"
> SMS Test #1
OK
+CMGS: 250
  
```



### ATTENTION

AT+CMGF=1 sets the SMS to Text mode.

## Reading Short Messages

Follow these instructions to read a short message that was sent to the OnCell.

1. Type **AT+CMGF=1** and press **Enter**.
2. When a short message is received, the modem will respond with a storage number for the message. The storage number will appear as **+CMTI: "SM", x** (where **x** is the storage number).
3. Type **AT+CMGR=x** to read the message (where **x** is the storage number of the message).

In the example, the storage number is **5**, which means that the message is stored in the 5<sup>th</sup> storage location.

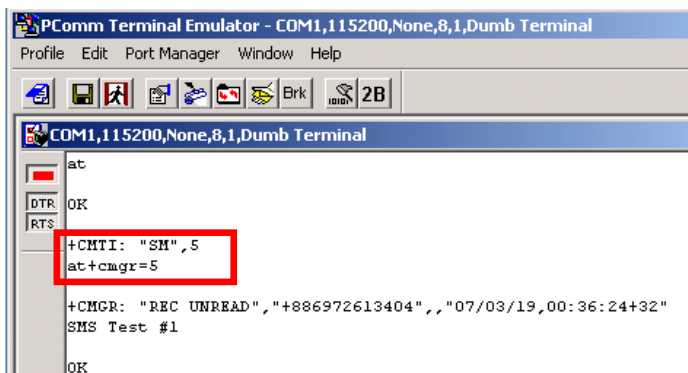

```

PCComm Terminal Emulator - COM1,115200,None,8,1,Dumb Terminal
Profile Edit Port Manager Window Help
COM1,115200,None,8,1,Dumb Terminal
at
DTR OK
RTS +CMTI: "SM", 5
at+cmgr=5
+CMGR: "REC UNREAD", "+886972613404", "07/03/19,00:36:24+32"
SMS Test #1
OK
  
```

## Deleting Short Messages

Follow these instructions to delete a short message.

1. Type **AT+CMGD=*x*,*n*** and press **Enter**. For ***x***, select one of the following options:

**"REC UNREAD"** Shows received unread messages  
**"REC READ"** Shows received read messages  
**"STO UNSENT"** Shows stored unsent messages  
**"STO SENT"** Shows stored sent messages  
**"ALL"** Shows messages

For ***n***, select one of the following options:

- 0** Delete message at location <include the index number>
- 1** Delete all READ messages.
- 2** Delete all READ and SENT messages.
- 3** Delete all READ, SENT, and UNSENT messages.
- 4** Delete ALL messages. "REC UNREAD" Shows received unread messages.

2. The following example shows how to delete all short messages in the storage.

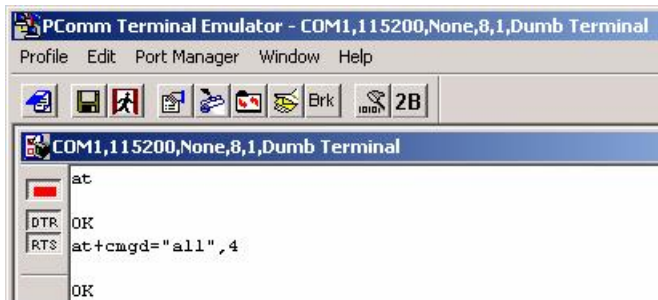

The screenshot shows a terminal window titled "PCOMM Terminal Emulator - COM1,115200,None,8,1,Dumb Terminal". The window contains the following text:

```
at
DTR: OK
RTS: at+cmgd="all",4
OK
```



### ATTENTION

Refer to the *OnCell G2111/G2151I AT Command Set* manual for additional information on AT commands for SMS.



The following topics are covered in this chapter:

□ **GPRS Overview**

□ **Windows GPRS Access**

- Installing the Modem Driver
- Modem Diagnostics
- Setting up the APN
- Adding Windows DUN Entry
- Internet Service Connection

## GPRS Overview

GPRS is a packet-switched technology, which means that multiple users share the same transmission channel. In addition, transmission only occurs when there is outgoing data. This means that the available bandwidth can be dedicated solely to data communication as needed. In general, a GPRS network can be viewed as a special IP network that offers IP connectivity to IP terminals. Devices such as PCs, embedded computers, and PLCs that are PPP-enabled can be easily connected to the IP network and the Internet.

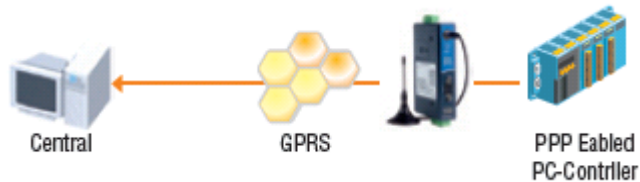

The OnCell G2111/G2151I Series modem is a multi-slot Class 10 device, which means that there are **4 Rx** timeslots plus **1 Tx** timeslot, or **3 Rx** timeslots plus **1 Tx** timeslot. This requires that the provider support CS-1 to CS-4 coding schemes. GPRS offers no guaranteed data rates or bandwidth. The value assigned by the provider (coding scheme and timeslots) can change dynamically during a connection.

In general, for the **1 Tx + 4 Rx** combination, the **Tx** throughput is around 8 to 12 Kbps and the **Rx** throughput is around 32 to 48 Kbps.

For the **2 Tx + 3 Rx** combination, the Tx throughput is around 8 to 12 Kbps and the Rx throughput is around 32 to 48 Kbps.

## Windows GPRS Access

The OnCell G2111/G2151I Series modem can use Windows DUN (Dial-up Networking) to provide Internet access through the GPRS mobile network. The following pages explain how to configure the modem and your Windows system for GPRS access.



### ATTENTION

The specific steps may vary depending on your version of Windows and your Windows settings.

## Installing the Modem Driver

1. In the Control Panel, open "Phone and Modem Options" and go to the "Modem" tab. Click Add to add a new modem.

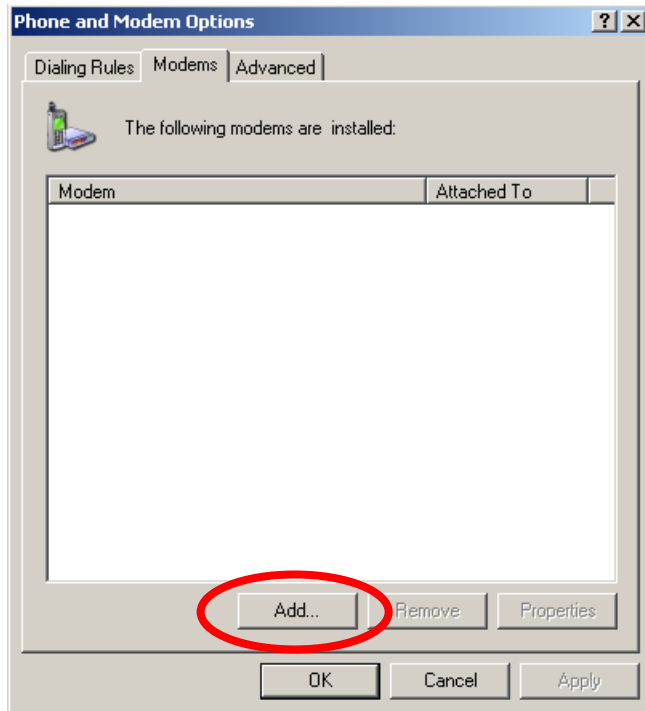

### ATTENTION

The first time you access the Phone and Modem Options, Windows will ask you to input the area code. Enter the area code to proceed.

2. When the Install Mode window opens, select **Don't detect my modem, I will select it from a list** and click **Next**.

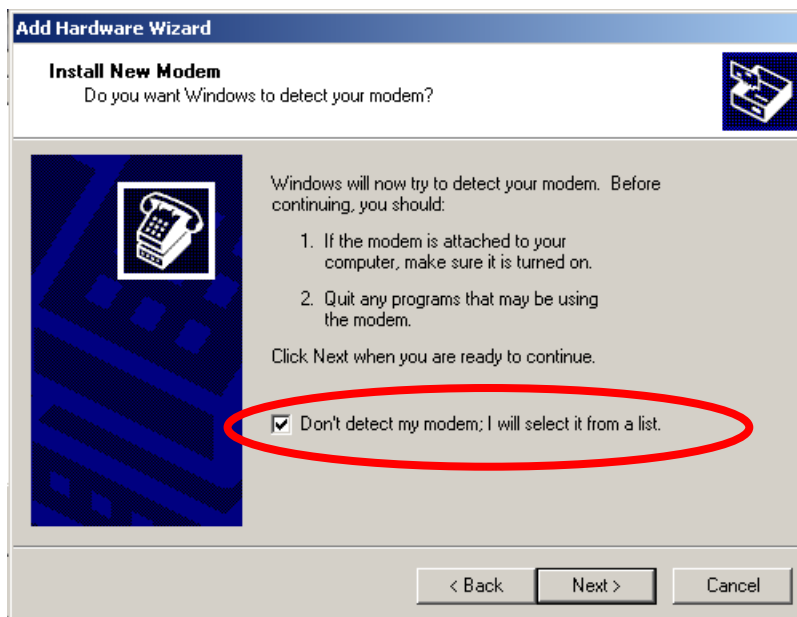

- Next, select **Standard Modem Types** and then select Standard 19200 bps modem

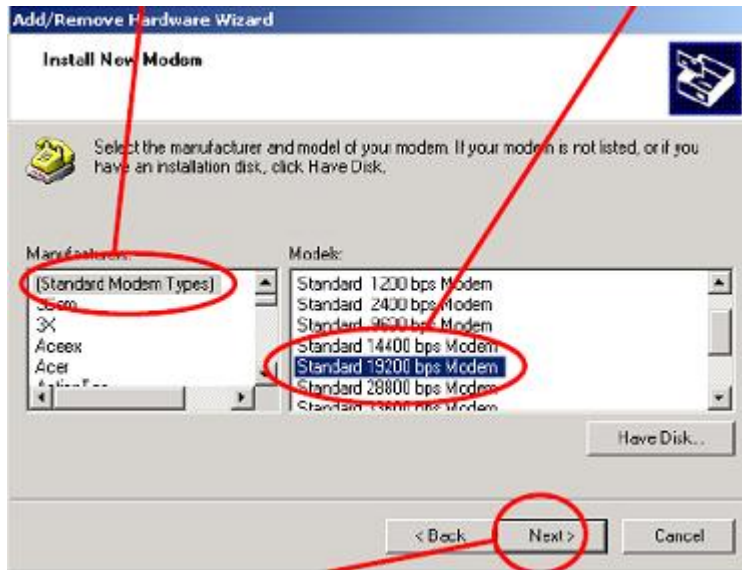

- When the next window opens, select the COM port that you are using and click **Next**.

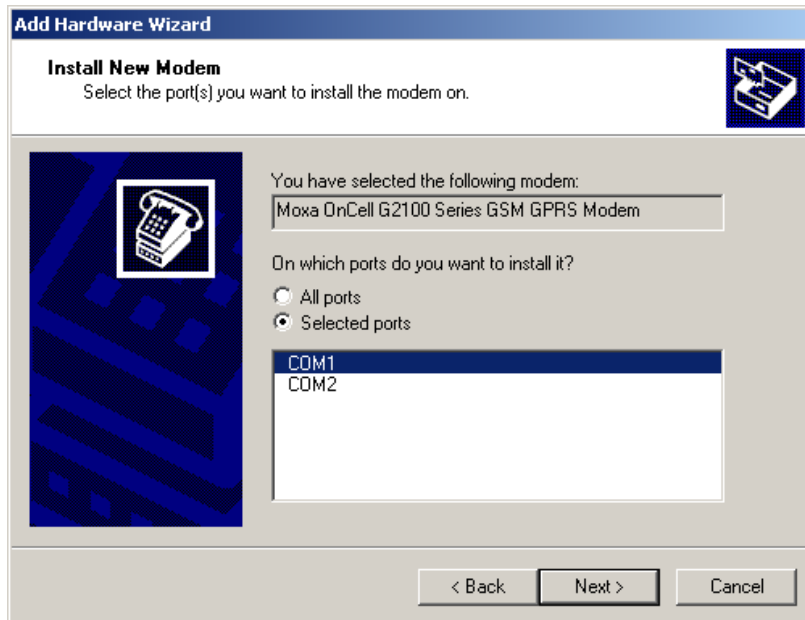

5. Click **Finish** to complete the installation procedure.



6. At this point, the OnCell G2111/G2151I Series driver should be listed in "Phone and Modem Options" on the "Modems" tab.

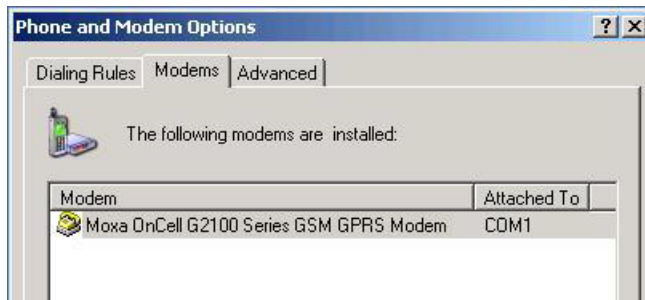

## Modem Diagnostics

The following instructions explain how to verify that the modem is installed properly and has been activated.

1. From the Control Panel, open **Phone and Modem Options**. On the **Modem** tab, click **Properties**.

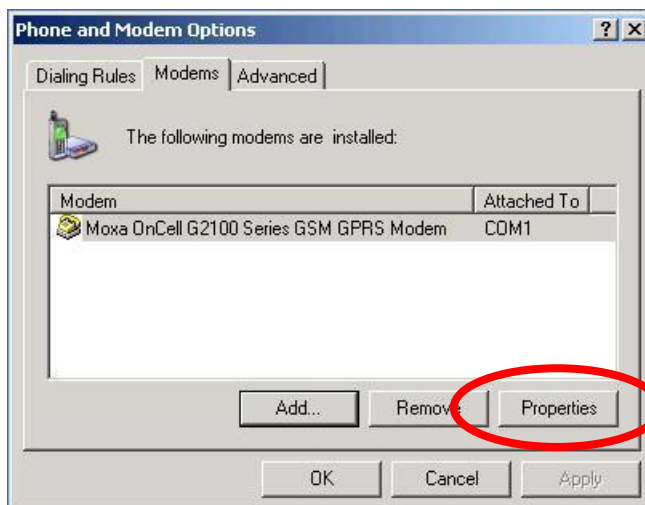



**ATTENTION**

Make sure that the RS-232 port of the OnCell G2111/G2151I Series modem is connected. For the OnCell G2151I, make sure DIP switch 1 is set to ON.

2. On the Diagnostics tab, click **Query Modem**.

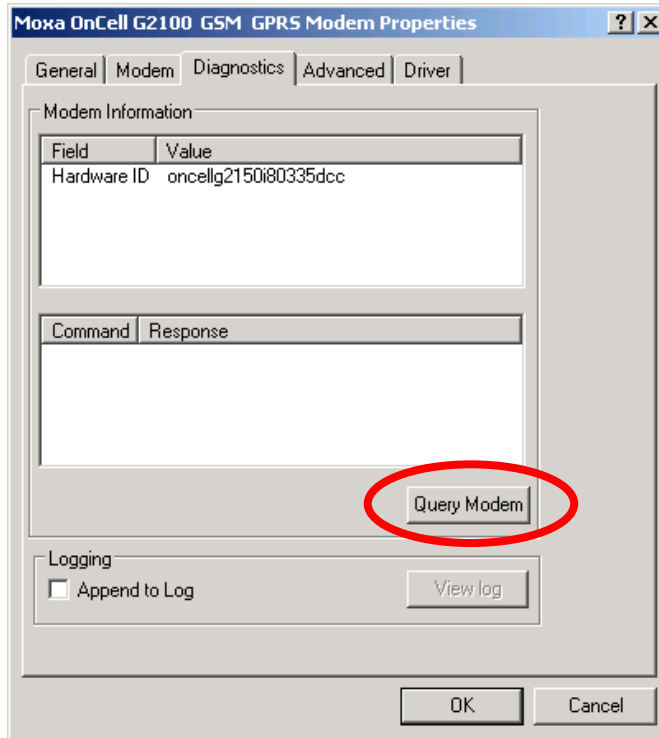

3. If the query is successful, you will be able to see commands that are sent to the modem and the modem's responses.

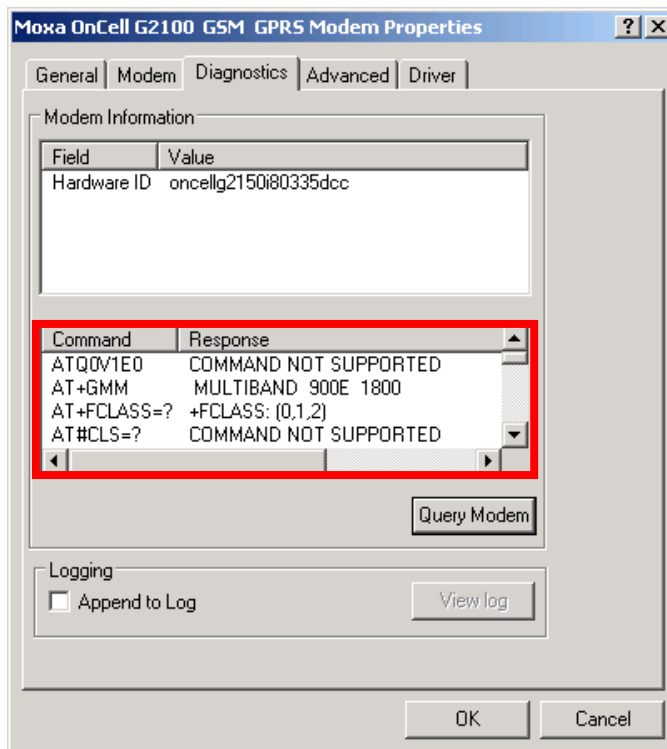

## Setting up the APN

Before using GPRS connection in Windows, the APN (Access Point Name) must be added as a modem initialization command. The following instructions explain how to set up the APN.



### ATTENTION

Check the signal strength indicators on the front panel of the OnCell G2111/G2151I Series modem. If the LED indicators are dark, then the SIM card is not installed properly, or the modem is not picking up a signal. If only one bar lights up, the signal is not strong enough for a GPRS connection. Adjust the position of the antenna, change the location of the installation, or use an optional high-gain antenna instead.

Make sure that your SIM card account supports GPRS service. In most regions, you will need to apply with your mobile service provider to activate the service.

Make sure that the RS-232 port of the OnCell G2111/G2151I Series modem is connected. For the OnCell G2151I, make sure DIP switch 1 is set to ON.

1. From the Control Panel, open **Phone and Modem Options**. On the **Modem** tab, click **Properties**.

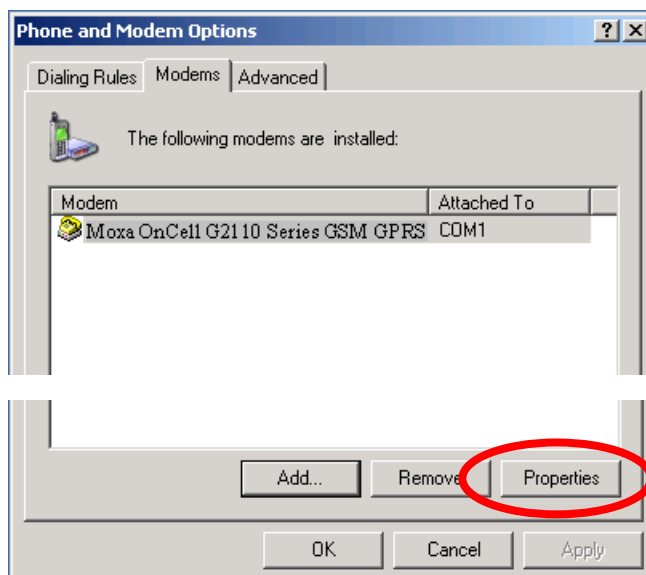

2. On the **Advanced** tab, enter the following in the **Extra initialization commands** field:  
**AT+CGDCONT=1,"IP",<APN>"**

For <APN>, use the correct service for your account, as in this example;

**AT+CGDCONT=1,"IP","ISP.CINGULAR"**

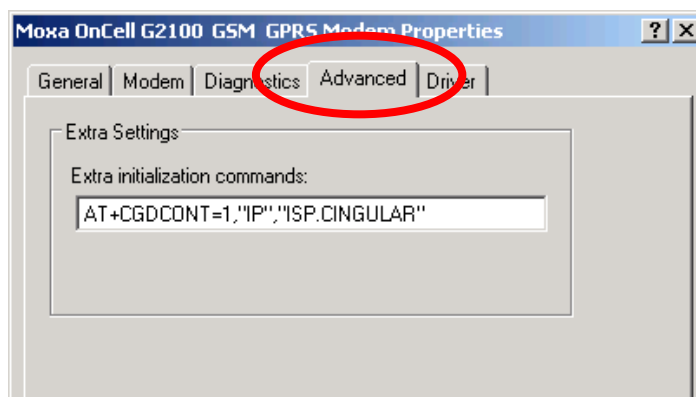

**ATTENTION**

The APN should be entered between the displayed brackets. Remember that the APN is case sensitive. Note that "IP" should be written in all capital letters. For a list of APNs, refer to the APN List on the Document and Software CD.

3. Click **OK** to close the **Properties** window.

## Adding Windows DUN Entry

The following instructions explain how to add a Windows Dial-up Networking entry.

1. In the Control Panel, open Network Connections and click **Create a new connection**.
2. When the **New Connection Wizard** window opens, select **Connect to the Internet** and click **Next**.

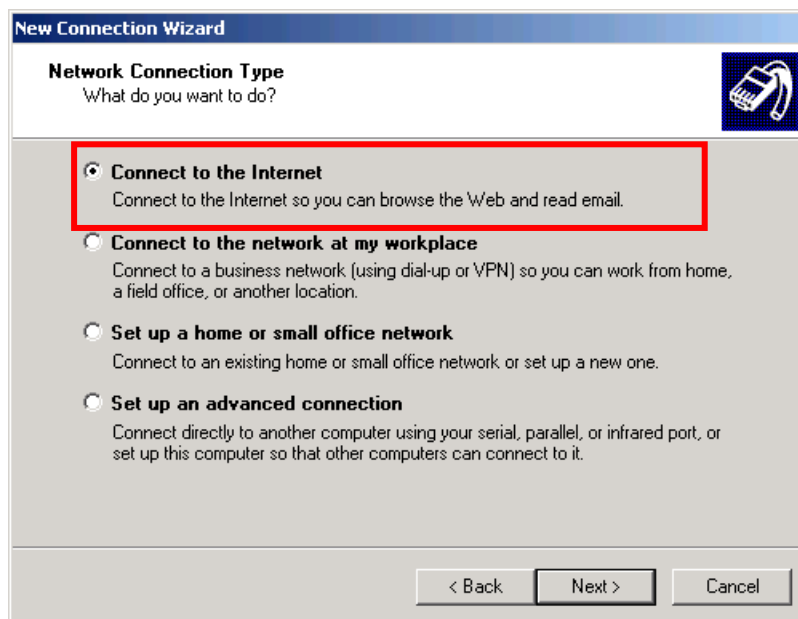

3. Select **Set up my connection manually** and click **Next**.

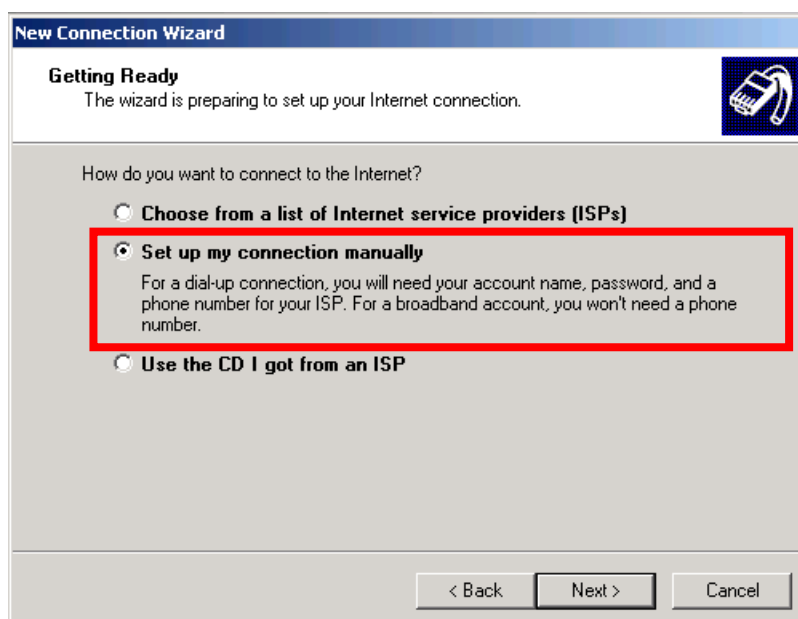



4. Select **Connect using a dial-up modem** and click **Next**.

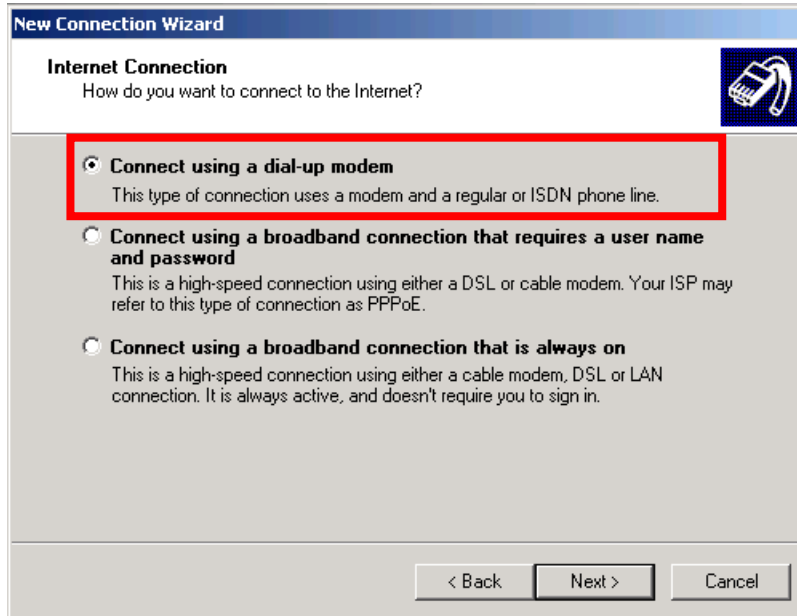

5. Enter the name of your service provider and click **Next**.

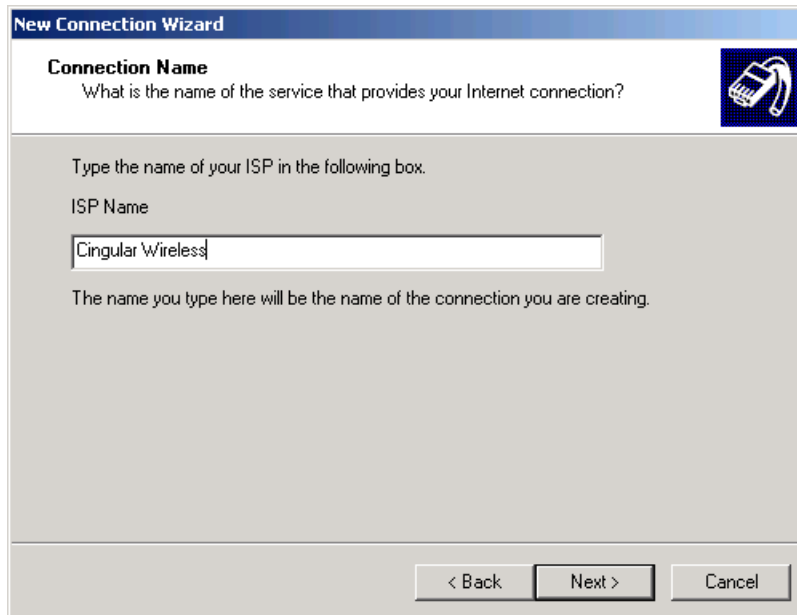

6. Enter **\*99\*\*\*1#** for the phone number and click **Next**.



**ATTENTION**

The phone number **\*99\*\*\*1#** is a special phone number that is used globally to request GPRS IP service from the carrier. **DO NOT** modify this phone number in any way. The same number is used regardless of the country that you are located in.

7. Enter the **User name** and **Password** as prompted and click **Next**.



**ATTENTION**

For a list of User names and Passwords, refer to APN List on the Document and Software CD, or consult your service provider for further details.

8. Click **Finish**.



9. In the next window that opens, click **Properties**.

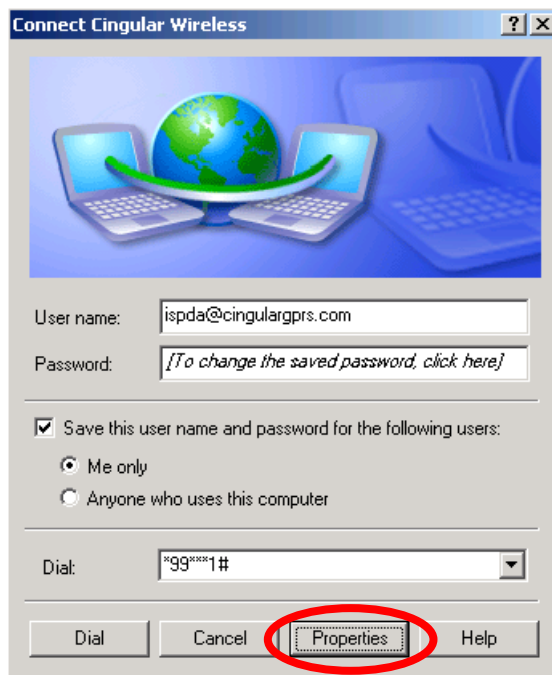

- Verify that **Use dialing rules** on the **General** tab is NOT selected.

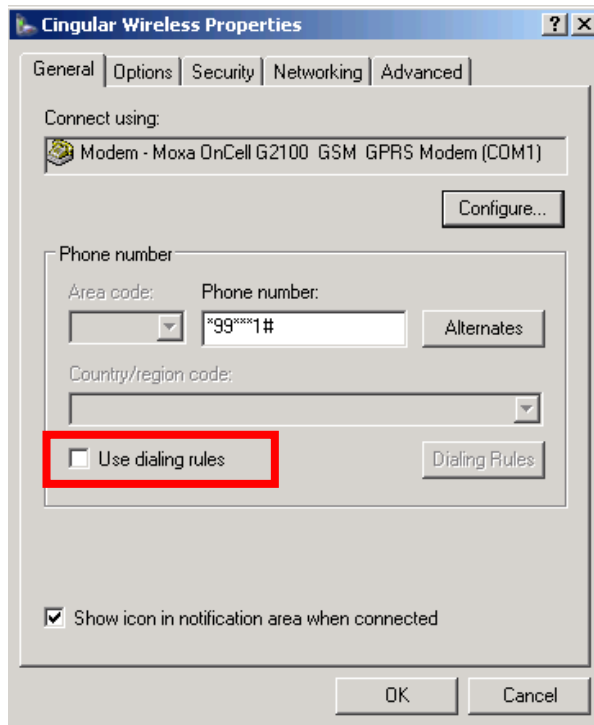

- On the **Networking** tab, select **Internet Protocol (TCP/IP)** and click **Properties** to set the DNS IP address.

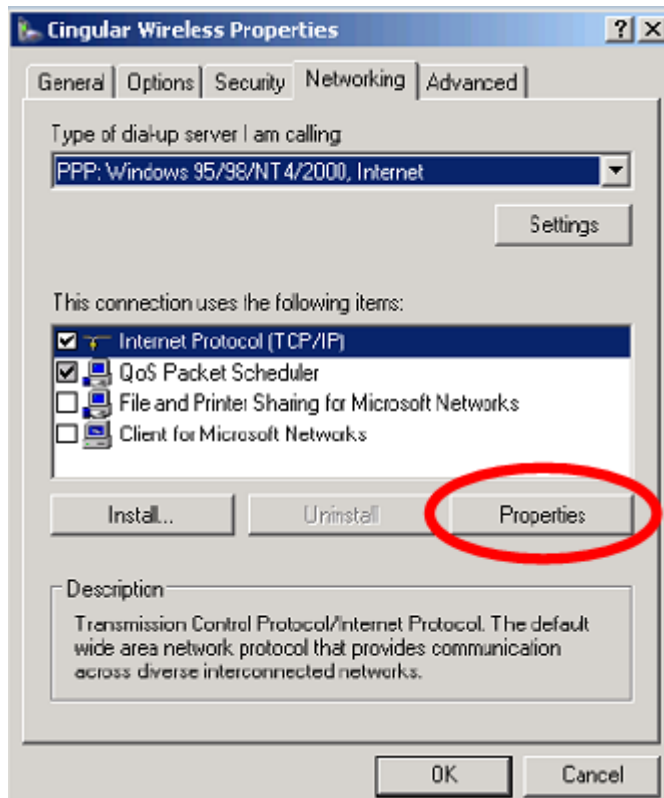

- If you know the IP address of the DNS server, select **Use the following DNS server addresses** and enter the IP address(es) as prompted. Click **OK**.

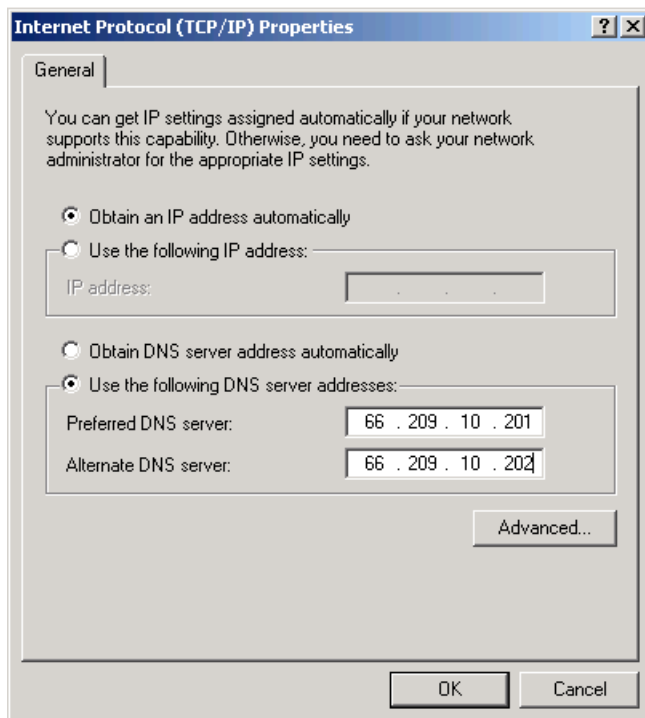

**ATTENTION**

For detailed DNS information, refer to the APN List on the Document and Software, or consult your service provider for further details.

- Click **OK**.

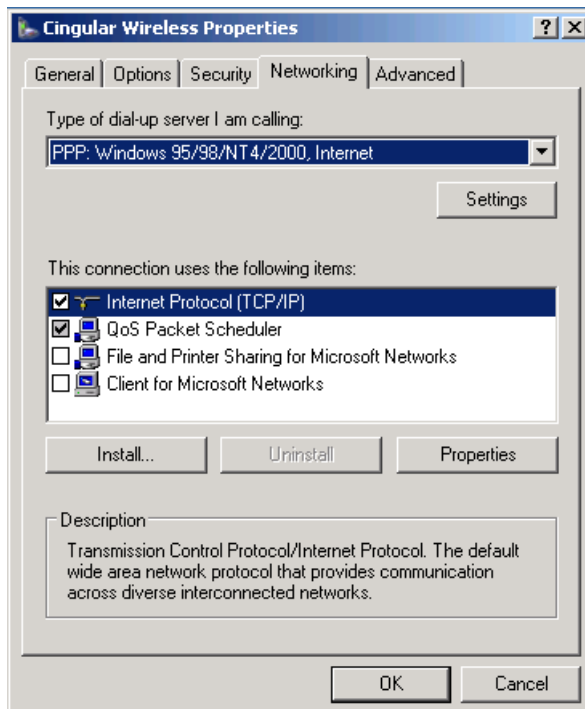

14. In the next window that appears, click **Dial** to establish the connection.

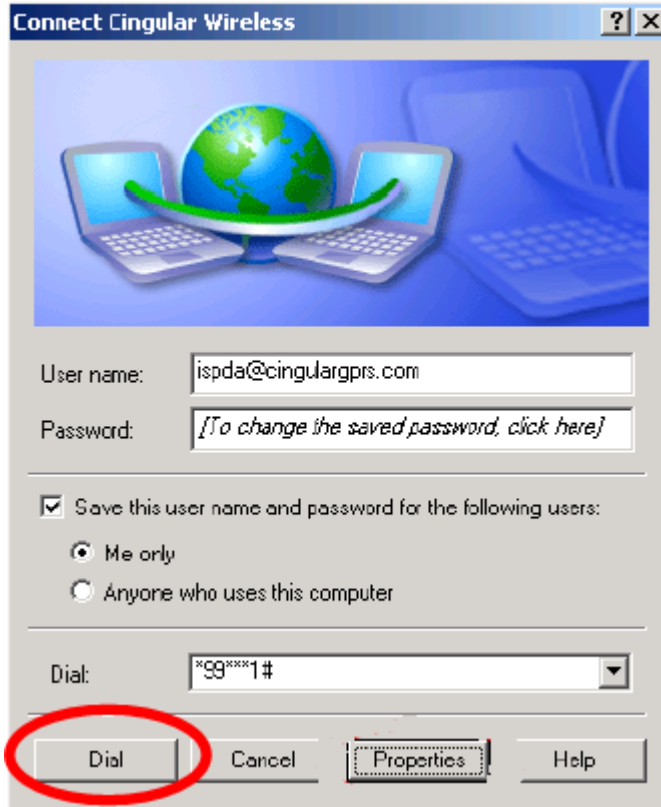

## Internet Service Connection

The G2101 Series has an embedded TCP/IP stack that is driven by AT commands that enable the host application to easily access the Internet. The advantage of this solution is that it eliminates the need for the application manufacturer to implement their own TCP/IP and PPP stacks, thus minimizing cost and time to integrate Internet connectivity into a new or existing host application. For a detailed description of the Internet Service Connection AT commands, refer to the AT command list available on the Moxa website.

Here is an example of how to establish a transparent TCP client connection using the Internet Service Connection commands:

1. Have the TCP server application ready at the host station with opened local ports.

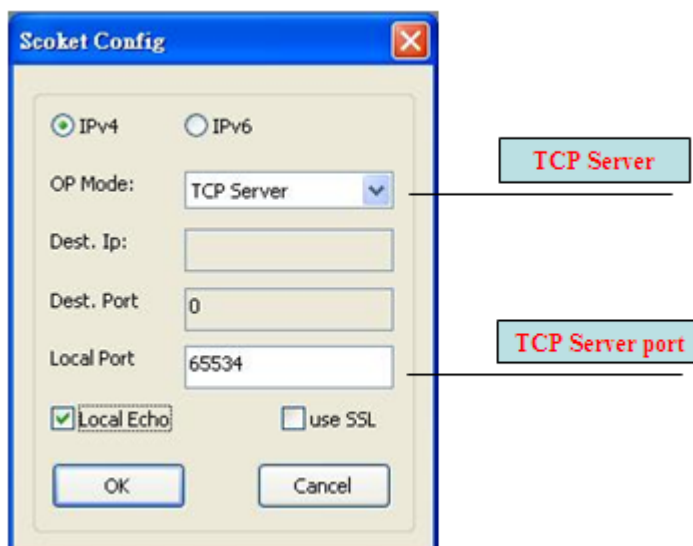

2. At the OnCell's terminal input (OnCell is a TCP client), type:

AT Command	Description
at^sics=0,conType,GPRS0  OK	Establish a connection (id=0) in GPRS mode
at^sics=0,apn,internet  OK	Enter APN
at^siss=0,srvType,transparent  OK	Select Transparent mode
at^siss=0,conId,0  OK	Specify current session's connection ID (id=0)
at^siss=0,address,"60.251.94.119:65534:timer=200"  OK	Specify the TCP server's IP
at^siso=0  OK	Open session id=0
at^sist=0 CONNECT	Enter transparent access mode

3. The OnCell is now in data mode ready for transparent data communication. Enter text data (i.e., 0123456789) at the OnCell terminal and read the sent text at the TCP server end:

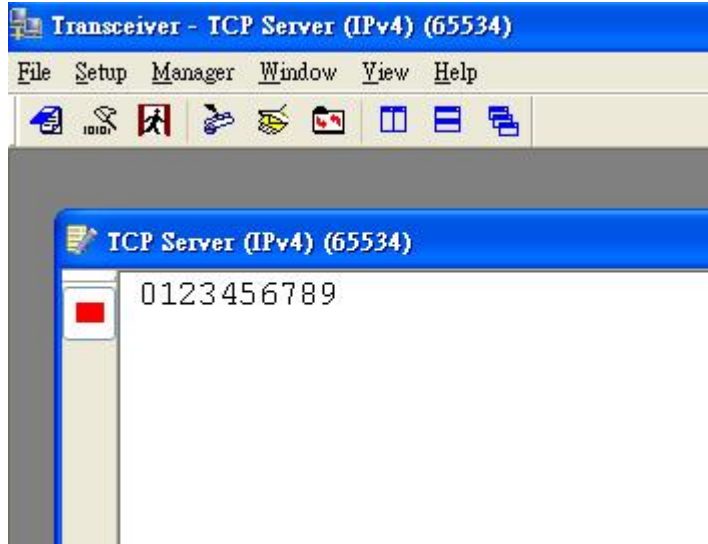

4. To end data communication and return to AT command mode, enter +++.

## GPRS with the UC-7110 and UC-7112

---

Moxa's UC-7110 and UC-7112 are small embedded computers that can be used for applications such as transportation control, light control, factory/building automation, and power utilities. However, for some applications it is either inconvenient or impossible to connect to the embedded computers with a traditional landline. In this case, the OnCell G2111/G2151I Series modem is a great solution for providing GSM/GPRS connectivity to the UC-7110 or UC-7112.



You can refer to step-by-step installation guide and a reference script in the **/Linux** folder on the Document and Software CD.



## Federal Communications Commission Interference Statement

---

This equipment has been tested and found to comply with the limits for a Class A digital device, pursuant to Part 15 of the FCC Rules. These limits are designed to provide reasonable protection against harmful interference in a residential installation. This equipment generates, uses and can radiate radio frequency energy and, if not installed and used in accordance with the instructions, may cause harmful interference to radio communications. However, there is no guarantee that interference will not occur in a particular installation. If this equipment does cause harmful interference to radio or television reception, which can be determined by turning the equipment off and on, the user is encouraged to try to correct the interference by one or more of the following measures:

- Reorient or relocate the receiving antenna.
- Increase the separation between the equipment and receiver.
- Connect the equipment into an outlet on a circuit different from that to which the receiver is connected.
- Consult the dealer or an experienced radio/TV technician for help.

### **CAUTION:**

Any changes or modifications not expressly approved by the grantee of this device could void the user's authority to operate the equipment.

### **FCC RF Radiation Exposure Statement**

This equipment complies with FCC RF radiation exposure limits set forth for an uncontrolled environment. This equipment should be installed and operated with a minimum distance of 20cm between the radiator and your body.

This device complies with Part 15 of the FCC Rules. Operation is subject to the following two conditions:

1. This device may not cause harmful interference and
2. This device must accept any interference received, including interference that may cause undesired operation.