

MiNePort E1/E2-SDK User Manual

Version 4.1, January 2022

www.moxa.com/product



© 2022 Moxa Inc. All rights reserved.

Product Name User Manual

The software described in this manual is furnished under a license agreement and may be used only in accordance with the terms of that agreement.

Copyright Notice

© 2022 Moxa Inc. All rights reserved.

Trademarks

The MOXA logo is a registered trademark of Moxa Inc.
All other trademarks or registered marks in this manual belong to their respective manufacturers.

Disclaimer

- Information in this document is subject to change without notice and does not represent a commitment on the part of Moxa.
- Moxa provides this document as is, without warranty of any kind, either expressed or implied, including, but not limited to, its particular purpose. Moxa reserves the right to make improvements and/or changes to this manual, or to the products and/or the programs described in this manual, at any time.
- Information provided in this manual is intended to be accurate and reliable. However, Moxa assumes no responsibility for its use, or for any infringements on the rights of third parties that may result from its use.
- This product might include unintentional technical or typographical errors. Changes are periodically made to the information herein to correct such errors, and these changes are incorporated into new editions of the publication.

Technical Support Contact Information

www.moxa.com/support

Table of Contents

1. Introduction	5
Overview	5
Package Checklist	5
Product Features	5
Panel Layout	6
MiiNePort E1-SDK Evaluation Board Panel Layout	6
MiiNePort E2-SDK Evaluation Board Panel Layout	7
Pin Assignments	8
Block Diagram	8
For MiiNePort E1-SDK Module	8
For MiiNePort E2-SDK Module	9
LED Indicators	9
2. Getting Started	11
Wiring Precautions	11
Selecting the Serial Interface	11
Connecting Power	12
Connecting MiiNePort USB to PC	13
Connecting to the Network	15
Connecting to a Serial Device	15
Digital I/O Channel Settings	15
Schematic Design Guide	16
3. Choosing the Proper Operation Mode	17
Overview	17
RealCOM Mode	17
Ethernet Modem Mode	18
4. Utility Console and Driver Installation	19
Device Search Utility (DSU)	19
Installing the Device Search Utility	19
Device Search Utility Configuration	21
NPort Windows Driver Manager	22
Installing NPort Windows Driver Manager	22
Using NPort Windows Driver Manager	24
Command Line Installation/Removal	26
Linux Real TTY Drivers	28
Installing Linux Real TTY Driver Files	28
Mapping TTY Ports	28
Removing Mapped TTY Ports	29
Removing Linux Driver Files	29
UNIX Fixed TTY Drivers	29
Installing the UNIX Driver	30
Configuring the UNIX Driver	30
5. MiiNePort IDE Development Tool	32
Installing MiiNePort IDE	32
Starting MiiNePort IDE	36
Create MiiNePort-SDK Project	36
RealCOM Mode	39
Ethernet Modem Mode	40
Sample Application	41
Data Packing	42
Serial Command Mode	43
Web Console	48
CLI	48
SNMP agent	49
TFTP Server	50
CPU Monitor	51
Wizards	52
Modify project dependency	52
Configuration Wizard	56

SCM Wizard	59
SNMP Wizard	62
User App Wizard	65
Build project	66
Upload debug version firmware to MiiNePort	66
Debug current active project.....	66
Upload your customized firmware to MiiNePort.....	67
6. NetEZ Technologies	69
SCM (Serial Command Mode)	69
EXTrigger (External Trigger)	70
EZPower	71
7. Android API Instructions	72
Overview	72
How to Start MxNPortAPI	73
MxNPortAPI Function Groups	74
Example Program	74
A. Introduction to SCM (Serial Command Mode) Command Set	75
Command/Reply Format	75
Single Line Command Format	75
Single Line Reply Format.....	75
Head and Tail Format.....	75
Operation Codes	75
Status Codes	75
Restriction.....	75
Command Code.....	76
Command Code for Getting the Configuration	76
Command Codes for Retrieving Running Configuration.....	78
Command Codes for Viewing the Status	79
Control Command Codes.....	79
B. Well-Known Port Numbers	80
C. SNMP Agent with MIB II and RS-232 Like Groups	82
D. Supported File Systems	83
ROM File System	83
FAT File System.....	83

1. Introduction

The MiiNePort E1/E2-SDK series of embedded device servers is compact drop-in modules that can be integrated with your serial devices to enable connectivity to an Ethernet network. All MiiNePort E1/E2-SDK Series modules come equipped with built-in TCP/IP protocols and other easy-to-use network enabling tools for fast integration, allowing you to provide network access to any electronic device with a serial port.

Overview

The Moxa MiiNePort E1/E2-SDK Series products are serial-to-Ethernet embedded modules. Moxa provides development and debug kit, which includes JTAG, an Eclipse-based integrated software development tool, and a source-level debugger. The following table lists the model names of all MiiNePort E1/E2-SDK series modules, along with the model names of the corresponding starter kits.

Package Checklist

Available Models:

- MiiNePort E1-SDK: Software Development Kit for the MiiNePort E1 Series, MiiNePort E1 module included
- MiiNePort E2-SDK: Software Development Kit for the MiiNePort E2 Series, MiiNePort E2 module included

Package Checklist:

- MiiNePort E2-SDK module or MiiNePort E1-SDK module
- MiiNePort E2-SDK evaluation board or MiiNePort E1-SDK evaluation board
- Universal power adapter
- 2 power cords
- Null modem cable
- Crossover Ethernet cable
- Quick installation guide (printed)
- Warranty card



NOTE

Please notify your sales representative if any of the above items are missing or damaged.

Product Features

All MiiNePort E1/E2-SDK modules have the following general features:

- Eclipse-based integrated software development tool
- Source-level debugger
- Easy to build proprietary SNMP/CLI console
- Various serial-to-Ethernet sample code
- Mass production tool for easy firmware upload
- Supports RealCOM mode operation functions

Panel Layout

MiiNePort E1-SDK Evaluation Board Panel Layout

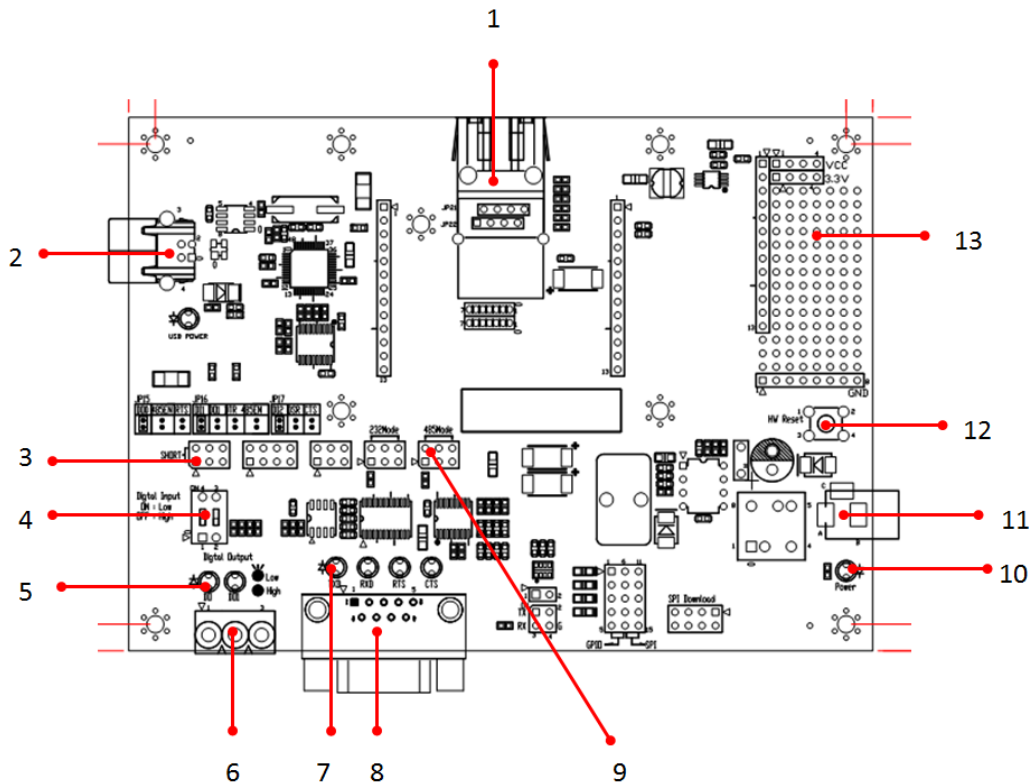

Number	Description
1	MiiNePort E1 Module Location
2	USB Type B Connector (Debug)
3	Configurable Pin Jumpers
4	Digital Input Switch
5	Digital Output LED
6	Digital IO Terminal Block
7	Serial Port Status LED
8	DB9 Male Connector
9	Serial Interface Jumper
10	Power LED
11	Power Jack
12	Restart Button
13	Circuit Pad



Users must set jumpers JP15, JP16, and JP17 to correspond with the functions of pins 6, 7, and 8, respectively, to ensure that the evaluation board works properly.



ATTENTION

When you are in RS-485 mode, 485EN must be configured by either JP15 or JP16, and the 6-pin jumper must be moved from JP19 to JP20.



ATTENTION

Before you manipulate the jumpers, be sure to disconnect the power first.

MiiNePort E2-SDK Evaluation Board Panel Layout

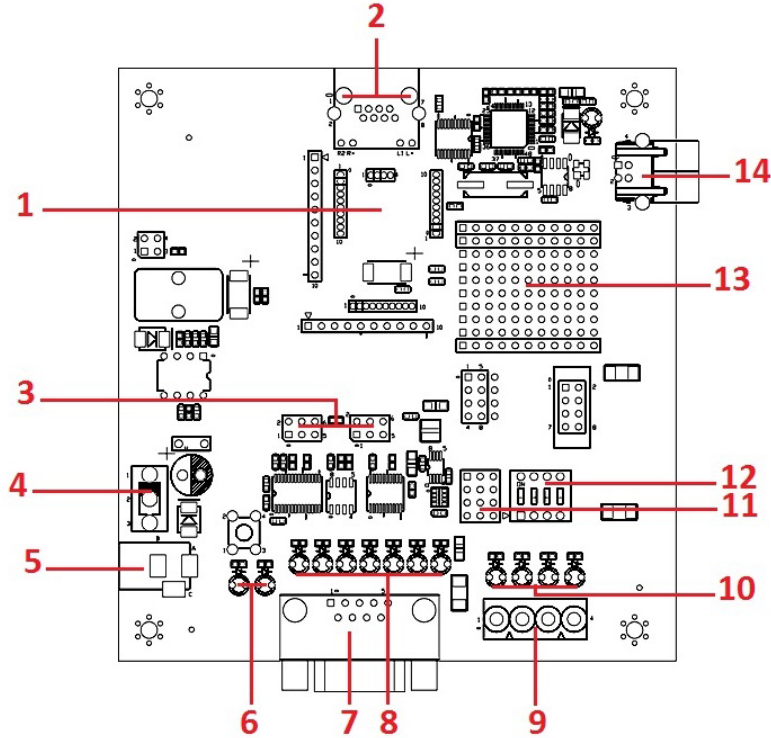

Number	Description
1	MiiNePort E2 Module Location
2	Ethernet RJ45 Connector
3	Serial Interface Jumpers
4	Power Switch
5	Power Jack
6	Power & Ready LED
7	DB9 Male Connector
8	Serial Port Status LED
9	Digital IO Terminal Block
10	Digital Output LED
11	Digital Input/Output Mode
12	Digital Input Switch
13	Circuit Pad
14	USB Type B Connector (Debug)

Pin Assignments

Ethernet Port Pins for MiiNePort E1/E2-SDK Modules

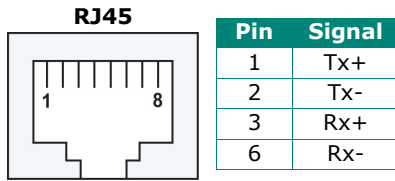

Serial Pin Signals for the MiiNePort E1/E2-SDK Evaluation Board

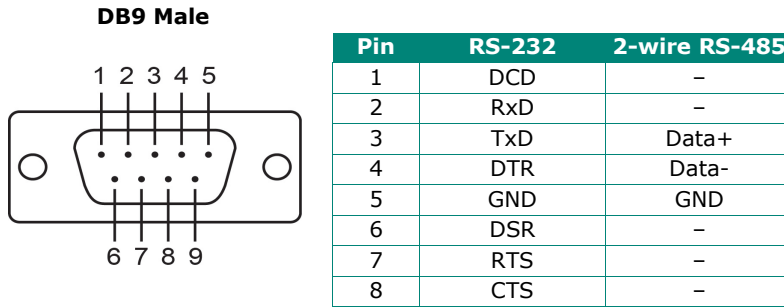

Block Diagram

For MiiNePort E1-SDK Module

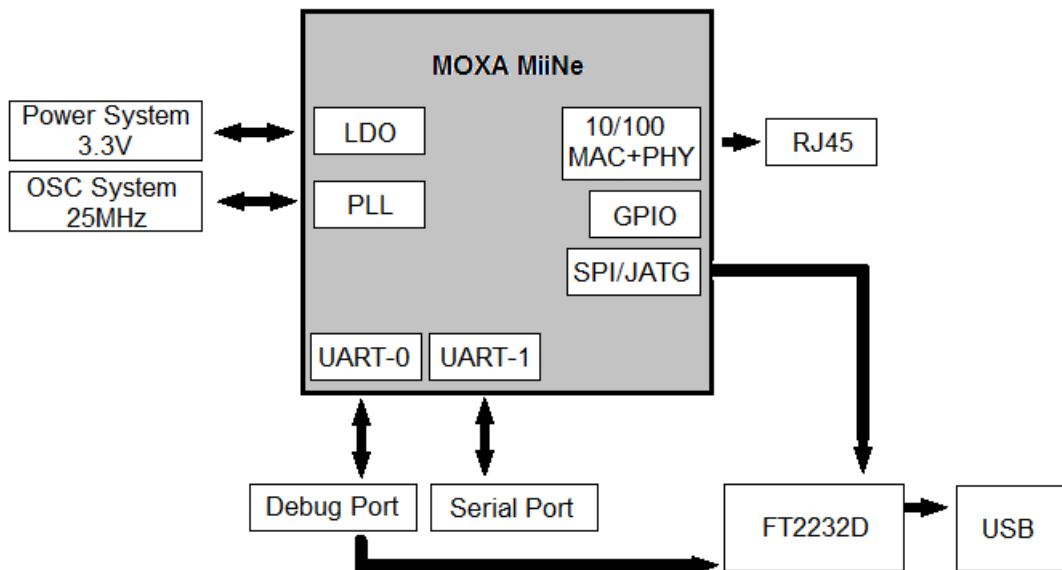

For MiiNePort E2-SDK Module

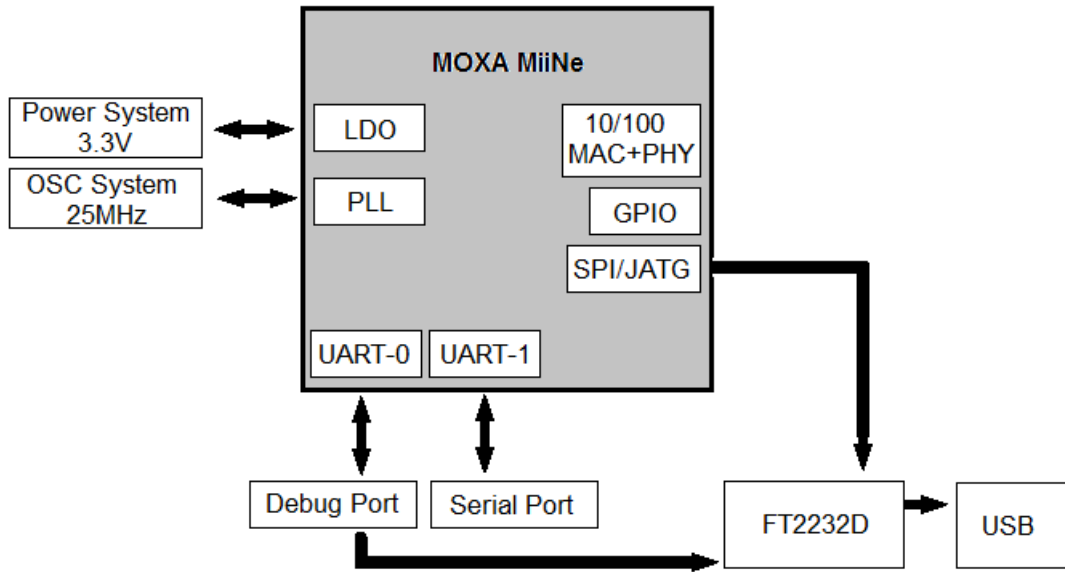

LED Indicators

MiiNePort E1-SDK Series Modules

LED	Color	Description
Left	Green	100BASE-TX Link Activity (constant on when link exists, blinks when data transmitting)
	Amber	10BASE-T Link Activity (constant on when link exists, blinks when data transmitting)
Right	Green	In Use (constant on when connection established)
	Amber	Fault (blinks when IP fault)

MiiNePort E1-SDK Evaluation Board

LED	Color	Description
Serial Signal TxD / LED D11	Red	Indicates that TxD has a signal
Serial Signal RXD / LED D12	Red	Indicates that RxD has a signal
Serial Signal RTS / LED D13	Red	Indicates that RTS has a signal
Power Signal / LED D43	Green	Indicates power input status
Digital Output / LED D17	Red	Indicates DO 0 "low" (0) status
Digital Output / LED D18	Red	Indicates DO 1 "low" (0) status

MiiNePort E2-SDK Evaluation Board

LED Name	Color	Description
Power	Off	1. Power is off 2. Power error 3. System error
	Green, steady on	The power is on.
Ready	Green, blinking every 1 sec.	1. The device server has been located by the NPort search utility's location function. 2. Auto Config complete.
	Green, blinking every 0.5 sec.	A LAN IP conflict, or the DHCP or BOOTP server did not respond properly.
TxD / LED D3	Red	TxD has a signal.
RxD / LED D4	Red	RxD has a signal.
DTR / LED D5	Red	DTR has a signal.
CTS / LED D6	Red	CTS has a signal.
DSR / LED D7	Red	DSR has a signal.
DCD / LED D8	Red	DCD has a signal.
RTS / LED D9	Red	RTS has a signal.
DO0 / LED D10	Red	DO0 is in "low" (0) status.
DO1 / LED D11	Red	DO1 is in "low" (0) status.
DO2 / LED D12	Red	DO2 is in "low" (0) status.
DO3 / LED D13	Red	DO3 is in "low" (0) status.
USB (Debug) Power	Green	The USB cable is connected to the PC.

2. Getting Started

This chapter includes information about how to install MiiNePort E1/E2-SDK modules for development and testing.

Wiring Precautions

This section describes some important safety precautions that you should pay attention to before proceeding with installation.



ATTENTION

Be sure to disconnect the power cord before installing or wiring the evaluation board.



ATTENTION

Determine the maximum possible current allowed in each power wire and common wire. Observe all electrical codes dictating the maximum current allowable for each wire size. If the current goes above the maximum capacity, the wiring could overheat, causing serious damage to your equipment.



ATTENTION

Take care when handling the evaluation boards. When plugged in, the evaluation boards' internal components generate heat, and the board may be too hot to touch.

You should also pay attention to the following:

- Do not run signal or communication wiring and power wiring in the same wire conduit. To avoid interference, wires with different signal characteristics should be routed separately. Separate paths should route wiring for power and devices. You can use the type of signal transmitted through a wire to determine the wires that should be kept separate. The rule of thumb is that wires sharing similar electrical characteristics may be bundled together.
- Keep input wiring and output wiring separate.
- If power wiring and device wiring paths must cross paths, make sure the wires are perpendicular at the intersection point.
- All wiring should be clearly labeled.

Selecting the Serial Interface

RS-232

MiiNePort E1-SDK: To use an RS-232 serial interface, place the 6-pin jumper on JP19.

MiiNePort E2-SDK: To use an RS-232 serial interface, place the 6-pin jumper on JP13.

RS-485

MiiNePort E1-SDK: To use an RS-485 serial interface, place the 2-pin jumper on the middle two pins of JP15 or the right-most two pins of JP16 (labeled as 485EN), and place the 6-pin jumper on JP20.

MiiNePort E2-SDK: Place the 6-pin jumper on JP14.

Connecting Power

For MiiNePort E1-SDK Evaluation Board Layout

Connect the 12-48 VDC power line with the power jack of the evaluation board. If the power is properly supplied, the power LED (D15, as shown in the following figure) on the evaluation board will show a solid red color until the system is ready, at which time the ready LED on the module will show a solid green color.

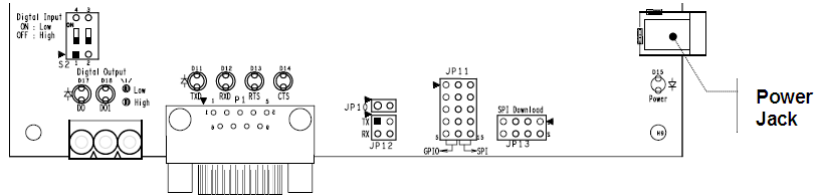

For MiiNePort E2-SDK Evaluation Board Layout

Connect the 12-48 VDC power line with the evaluation board's power jack. If the power is properly supplied, the power LED on the evaluation board (D14) will show a solid green color until the system is ready. When the system is ready, the ready LED on the module will show a solid green color.

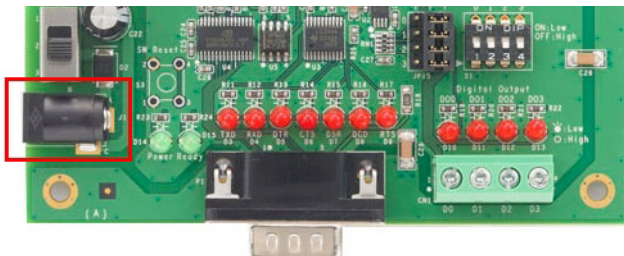

Connecting MiiNePort USB to PC

First, connect the MiiNePort USB port to the PC. Please use the USB cable to connect the USB port on the evaluation board to the PC. The figures below show the location of the USB port on the evaluation board.

E1 Evaluation Board

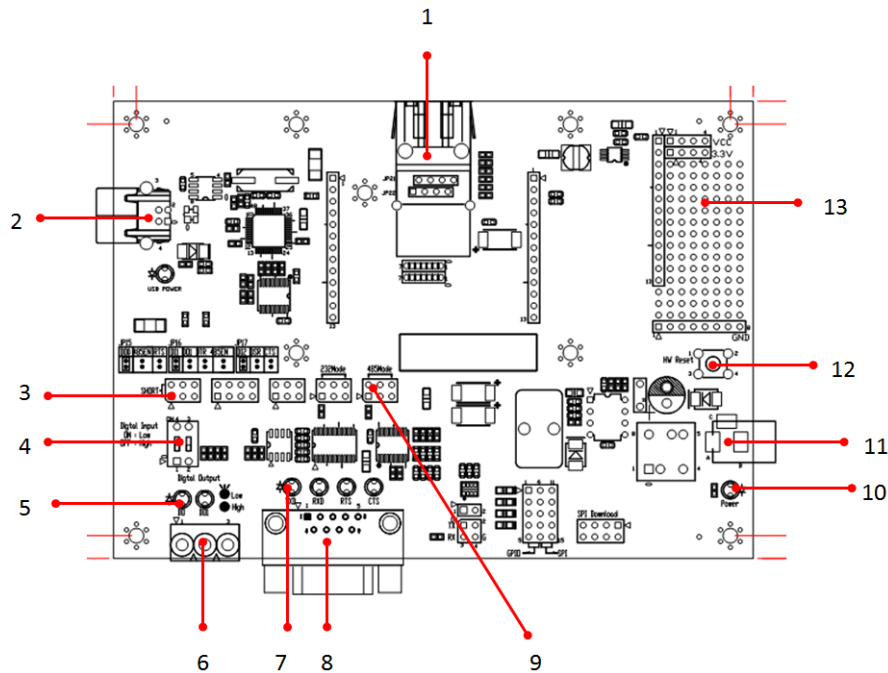

Number	Description
1	MiiNePort E1 Module Location
2	USB Type B Connector (Debug)
3	Configurable Pin Jumpers
4	Digital Input Switch
5	Digital Output LED
6	Digital IO Terminal Block
7	Serial Port Status LED
8	DB9 Male Connector
9	Serial Interface Jumper
10	Power LED
11	Power Jack
12	Restart Button
13	Circuit Pad

E2 Evaluation Board

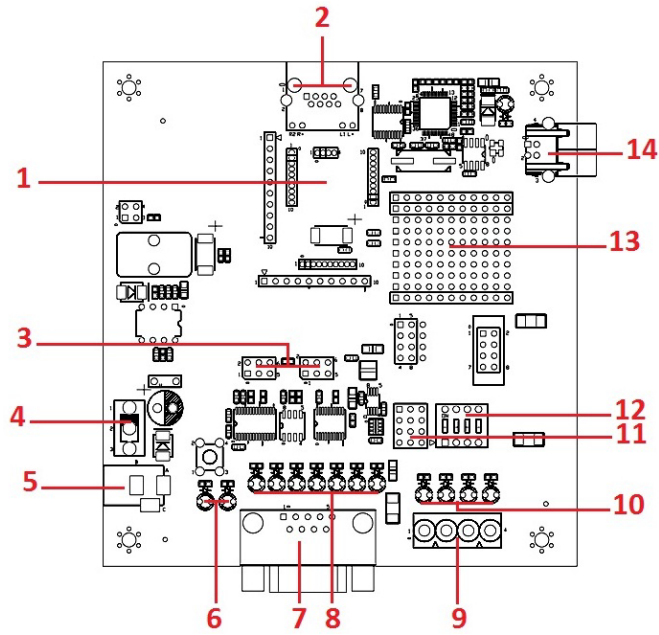

Number	Description
1	MiiNePort E2 Module Location
2	Ethernet RJ45 Connector
3	Serial Interface Jumpers
4	Power Switch
5	Power Jack
6	Power & Ready LED
7	DB9 Male Connector
8	Serial Port Status LED
9	Digital IO Terminal Block
10	Digital Output LED
11	Digital Input/Output Mode
12	Digital Input Switch
13	Circuit Pad
14	USB Type B Connector (Debug)

Connecting to the Network

To connect to the network for testing and development purposes, install the module on the evaluation board and then plug the Ethernet cable into the RJ45 jack on the module. If the cable is properly connected, the LED on the module will show a valid connection to the Ethernet as follows:

MiiNePort E1-SDK

LED	Color	Meaning
Left	Green	100BASE-TX Link Activity (constant on when link exists, blinks when transmitting data)
	Amber	10BASE-T Link Activity (constant on when link exists, blinks when transmitting data)
Right	Green	In Use (always on when connection is established)
	Amber	Fault (blinks when an IP fault exists)

MiiNePort E2-SDK

LED	Color	Meaning
Left	Amber	10BASE-T Link Activity (does not blink when not transmitting; blinks when transmitting)
Right	Green	100BASE-TX Link Activity (does not blink when not transmitting; blinks when transmitting)

When using a private IP address (factory default) for the module, make sure the netmask and IP settings are configured properly to access the module from a host on the network.

Connecting to a Serial Device

To connect to a serial device for testing and development purposes, the module should be installed on the evaluation board. Make sure the serial interface is configured correctly before connecting the evaluation board to the serial device. (Refer to **Selecting the Serial Interface** section in Chapter 1 when you are using jumper blocks to select the serial interface on the evaluation board.) The module's serial signals are routed to and from the RS-232 or RS-485 COM port on the evaluation board. Use a serial data cable to connect the serial device to the COM port on the evaluation board.

Digital I/O Channel Settings

For MiiNePort E1-SDK Evaluation Board Layout

Each module has three digital I/O (DIO) channels. (Refer to the **Pin Assignments** section in Chapter 1 for the module's configurable DIO pin description. Refer to **MiiNePort E1-SDK Evaluation Board Panel Layout** section in Chapter 1 to select the corresponding setting on the evaluation board.) Software may configure all three DIO channels. A DI channel is a channel that is operating in digital input mode; a DO channel is a channel that is operating in digital output mode. You may use the evaluation board's Digital Output LEDs and Digital Input DIP switches as the digital input and output devices, or you may connect digital input/output devices to the DIO Terminal Block.

For channels in digital output mode, **Low** and **High** status is controlled from within the web console. When using a Digital Output LED as your output device, **Low** status is expressed by the LED lighting up, and **High** status is expressed by the LED turning off.

For MiiNePort E2-SDK Evaluation Board Layout

Each module has four digital I/O (DIO) channels. (Refer to the **Pin Assignments** section in Chapter 1 for the module's configurable DIO pin descriptions. Refer to the **MiiNePort E2-SDK Evaluation Board Panel Layout** section in Chapter 1 to select corresponding settings on the evaluation board.) Software can configure all four DIO channels. A DI channel is a channel that operates in digital input mode; a DO channel is a channel that operates in digital output mode. You can use the evaluation board's Digital Output LEDs and Digital Input DIP switches as the digital input and output devices, or you can connect digital input/output devices to the DIO Terminal Block.

For channels in digital output mode, the **Low** versus **High** setting is controlled from the web console. When using a Digital Output LED as your output device, the LED will be on to show that the status is **Low** and the LED will be off to show that the status is **High**.



ATTENTION

When using a digital input device connected to the DIO Terminal Block, the corresponding Digital Input DIP switch must be set to **OFF** or **High**. Setting the DIP switch to **ON** or **Low** will interfere with the signal from your digital input device.

Schematic Design Guide

For guidance and suggestions on integrating your device's hardware with the MiiNePort, refer to the MiiNePort Schematic Design Guide on the MiiNePort's product page on Moxa's website.

3. Choosing the Proper Operation Mode

In this chapter, we will describe the operation modes supported by MiiNePort E1/E2-SDK modules. Modes are available for COM port mapping from the host computer, as well as operation modes for TCP/IP protocols. After choosing the operation mode in this chapter, refer to subsequent chapters for configuration details.

Overview

MiiNePort E1/E2-SDK modules act as a bridge to connect your serial devices to the Ethernet. The built-in TCP/IP stack frees you from the tedious task of programming networking protocols. With one step you can choose the proper operation mode, and then use your computer to access, manage, and configure your serial devices from anywhere in the world over the Internet.

Traditional SCADA and data collection systems rely on serial ports (RS-232/422/485) to collect data from a variety of instruments. Since MiiNePort E1/E2-SDK modules convert between serial and Ethernet signals, your SCADA and data collection system can be made accessible from any device connected to a standard TCP/IP network, regardless of whether the devices are used locally or at a remote site.

The MiiNePort E1/E2-SDK supports RealCOM mode and Ethernet Modem mode. You don't need to take effort to develop these two kinds of complex serial to Ethernet operating mode. Only do some setting to complete the function.

RealCOM Mode

RealCOM mode allows users to continue using software that was written for pure serial communications applications. Each module comes equipped with COM drivers for Windows systems (95 and above). The module's serial port is mapped by the driver to an IP address and port number. The driver intercepts data sent to the host's COM port, packs it into a TCP/IP packet, and then redirects it through the host's Ethernet card. At the other end of the connection, the module accepts the Ethernet frame, unpacks the TCP/IP packet, and then transparently sends the data to the attached serial device. The driver thus establishes a transparent connection between the host and serial device, allowing the host to treat the networked device as if it were directly attached.

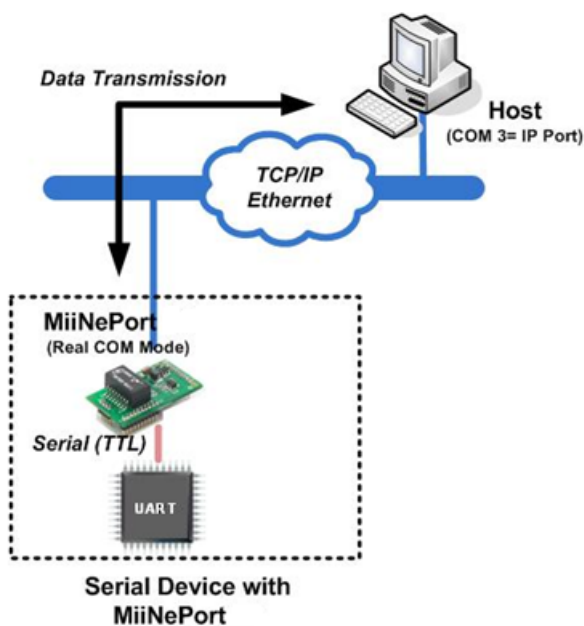



ATTENTION

The RealCOM driver comes with the NPort Windows Driver Manager, which can be found on the MiiNePort's product page on Moxa's website.

Ethernet Modem Mode

Ethernet Modem mode is designed for use with legacy operating systems, such as MS-DOS, that do not support TCP/IP Ethernet. By connecting the properly configured MiiNePort serial port to the MS-DOS computer's serial port, it is possible to use legacy software to transmit data over the Ethernet when the software was originally designed to transmit data over a modem.

4. Utility Console and Driver Installation

This chapter describes the installation of the MiiNePort E1/E2-SDK's utilities, which are used to perform simple configurations and driver installations.

Device Search Utility (DSU)

Installing the Device Search Utility

1. Click the setup file that can be downloaded from the MiiNePort's product page on Moxa's website to install the Device Search Utility. Once the program runs, click **Yes** to proceed.
2. Click **Next** when the Welcome screen opens to proceed with the installation.



3. Click **Browse** to select an alternate location and then click **Next** to install program files to the directory displayed in the input box.

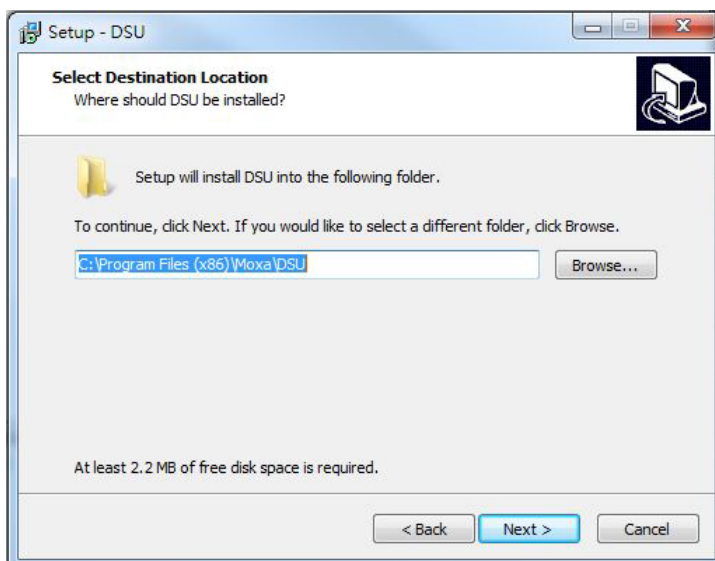

4. Select the additional tasks you would like to set up to be performed while installing DSU; then, click **Next**.

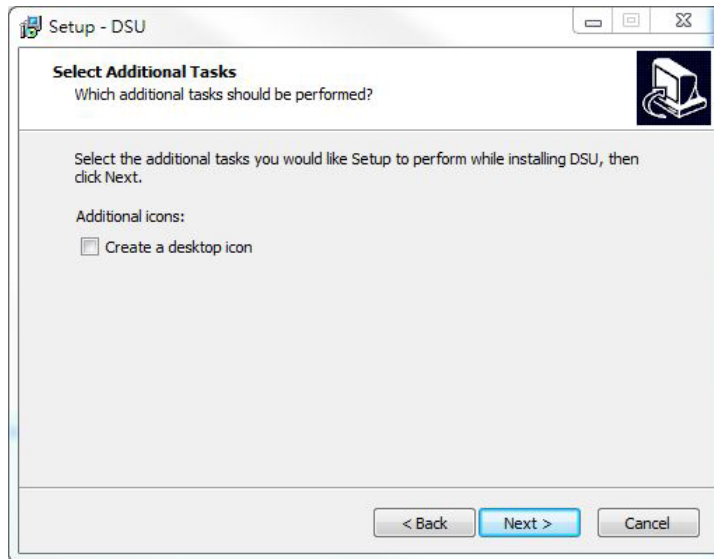

5. The installer will display a summary of the installation options. Click **Install** to begin the installation. The setup window will report the progress of the installation. To change the installation settings, click **Back** and navigate to the previous screen.

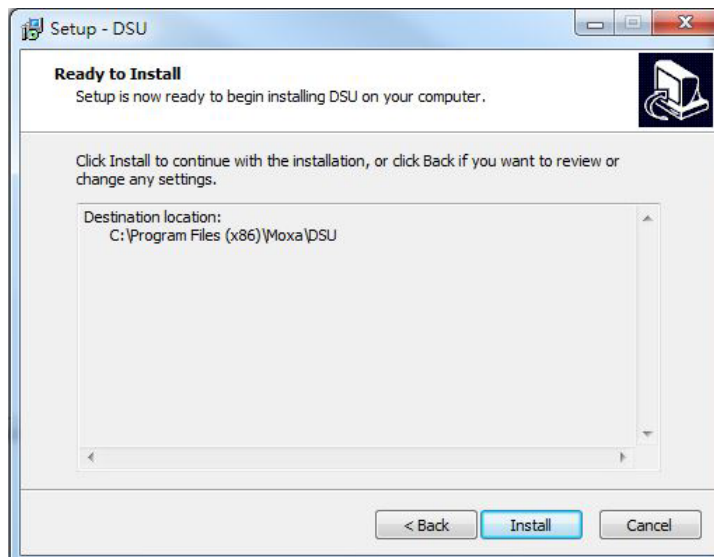

- Click **Finish** to complete the installation of the Device Search Utility.

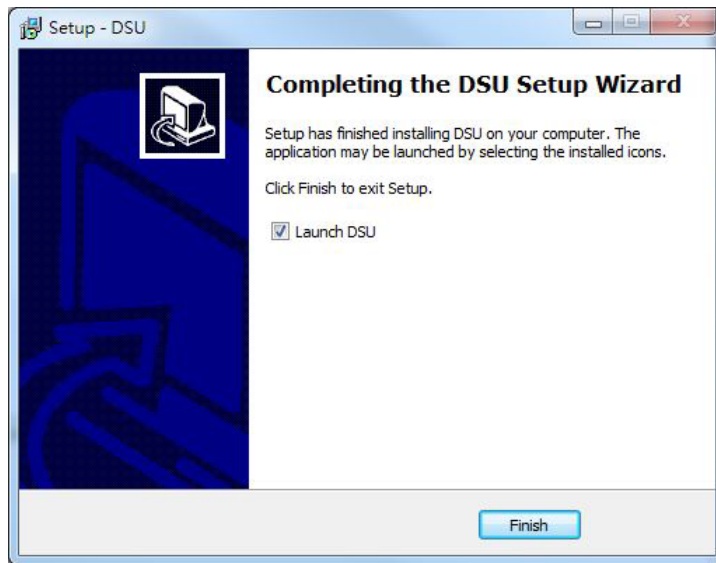

Device Search Utility Configuration

The Broadcast Search function is used to locate all MiiNePort E1/E2-SDK modules that are connected to the same LAN as your computer. After locating a MiiNePort E1/E2-SDK, you will be able to change its IP address. Since the Broadcast Search function searches by MAC address and not IP address, all MiiNePort E1/E2-SDK modules connected to the LAN will be located, whether or not they are part of the same subnet as the host.

- Start the **Device Search Utility** and then click the **Search** icon.

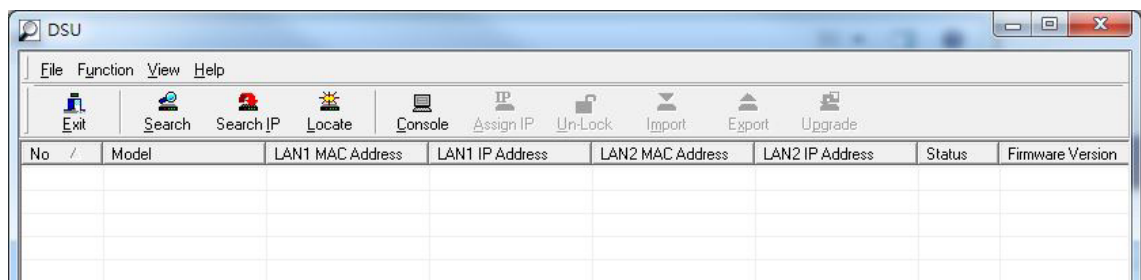

- The **Searching** window shows the progress of the search.

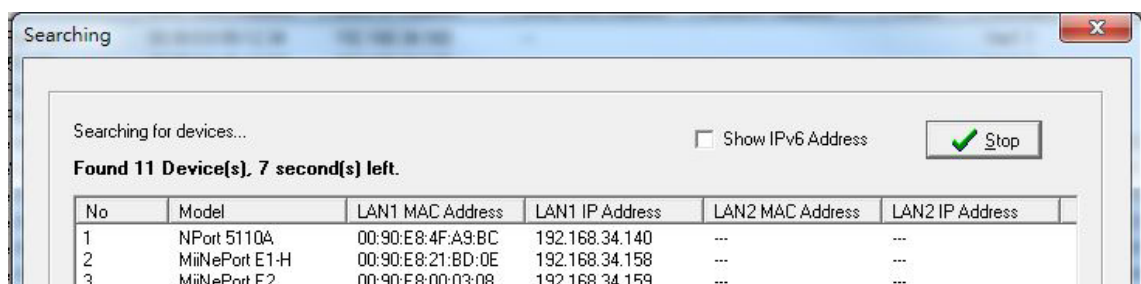

- When the search is complete, all MiiNePort E1/E2-SDK modules that were located will be displayed in the Device Search Utility window.

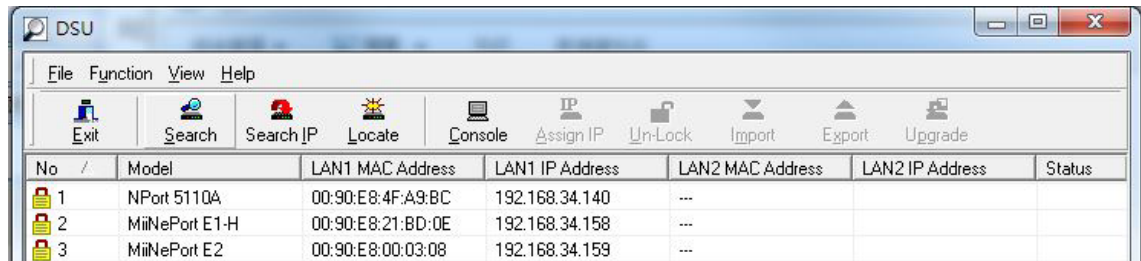

No	Model	LAN1 MAC Address	LAN1 IP Address	LAN2 MAC Address	LAN2 IP Address	Status
1	NPort 5110A	00:90:E8:4F:A9:BC	192.168.34.140	---		
2	MiiNePort E1-H	00:90:E8:21:BD:0E	192.168.34.158	---		
3	MiiNePort E2	00:90:E8:00:03:08	192.168.34.159	---		

- To modify the configuration of the highlighted MiiNePort E1/E2-SDK, click the **Console** icon to open the web console. This will take you to the web console, where you can make configuration changes.
- To upload your custom software, click the Upgrade icon to upload your firmware.



ATTENTION

The information below is only for RealCOM mode.

NPort Windows Driver Manager

Installing NPort Windows Driver Manager

The NPort Windows Driver Manager is intended for use with serial ports that are set to RealCOM mode. The software manages the installation of drivers that allow you to map unused COM ports on your PC to your device presented by the MiiNePort E1/E2-SDK's serial port. These drivers are designed for use with Windows 98, ME, NT, and Windows 7. When the drivers are installed and configured, devices that are embedded with the MiiNePort E1/E2-SDK will be treated as if they are attached to your PC's COM ports.

- Click the setup file that can be downloaded from the MiiNePort's product page on Moxa's website to install the NPort Windows Driver Manager.
- Click **Next** when the Welcome screen opens to proceed with the installation.

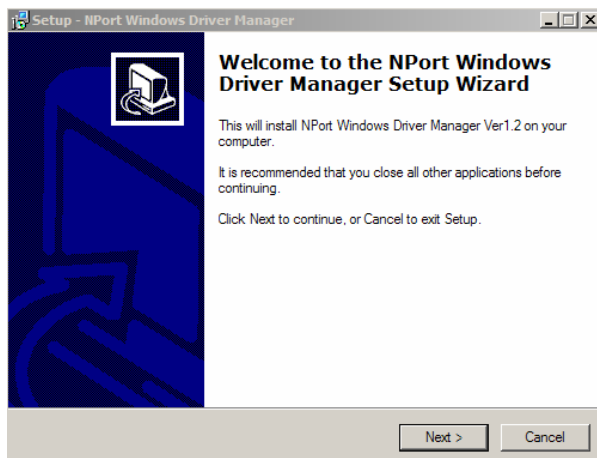

3. Click **Browse** to select the destination directory and then click **Next** to install program files to the directory displayed in the input box.

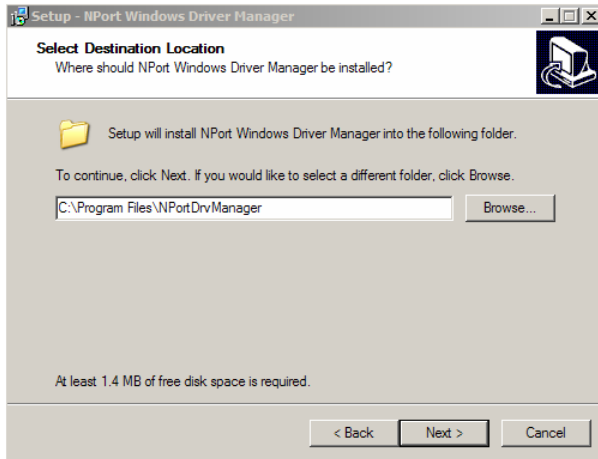

4. Click **Next** to install the program's shortcuts in the appropriate **Start Menu** folder.

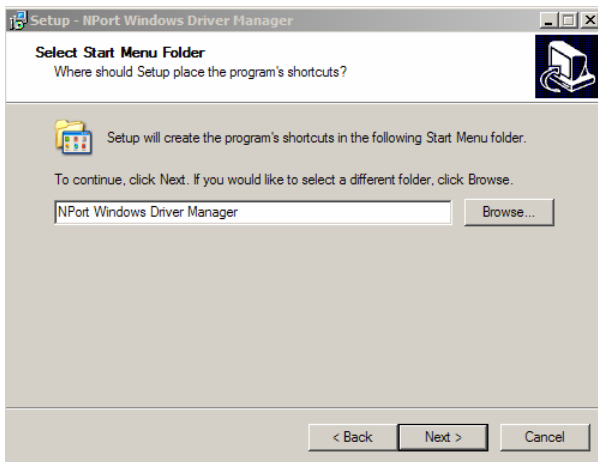

5. The installer will display a summary of the installation options. Click **Install** to begin the installation. The setup window will report the progress of the installation. To change the installation settings, click **Back** and navigate to the previous screen.

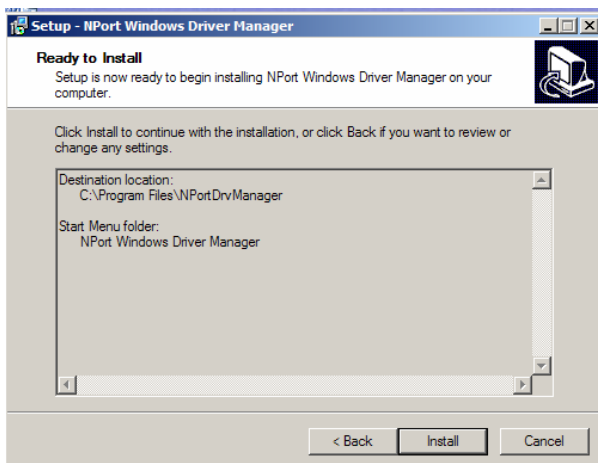

- Click **Finish** to complete the installation of NPort Windows Driver Manager.



Using NPort Windows Driver Manager

After you have installed the NPort Windows Driver Manager, you can set up the MiiNePort E1/E2-SDK serial port, which is connected to the device mainboard, as remote COM ports for your PC host. Make sure that the serial port on your MiiNePort E1/E2-SDK is set to RealCOM mode when mapping COM ports with the NPort Windows Driver Manager.

- Go to **Start → NPort Windows Driver Manager → NPort Windows Driver Manager** to start the COM mapping utility.
- Click the **Add** icon.

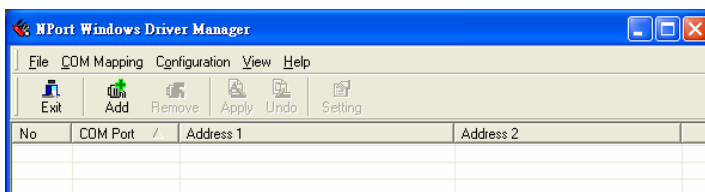

- Click **Search** to search for the MiiNePort E1 modules. From the list that is generated, select the server to which you will map COM ports, and then click **OK**.

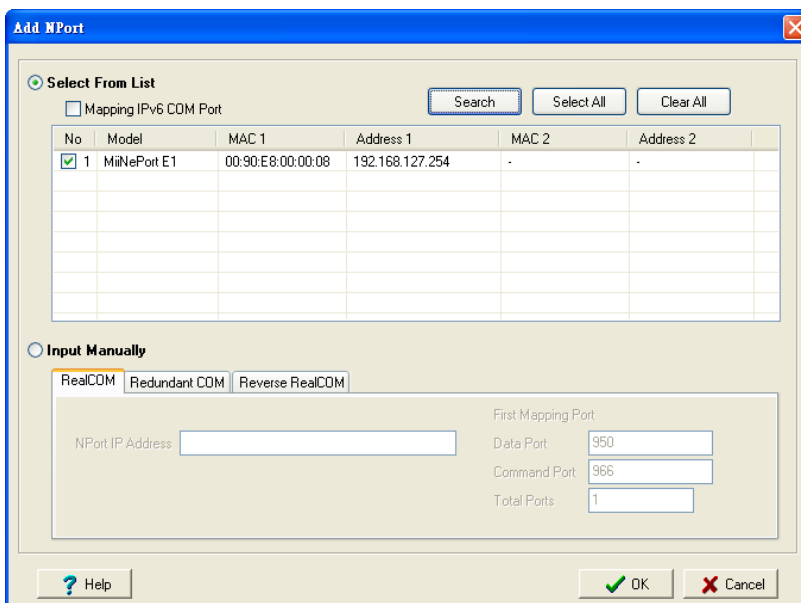

- Alternatively, you can select **Input Manually** and then manually enter the MiiNePort E1 module's **IP Address, 1st Data Port, 1st Command Port, and Total Ports** to which COM ports will be mapped. Click **OK** to proceed to the next step. Note that the NPort IP Address column supports FQDN (Fully Qualified Domain Name), in which case the IP address will be filled in automatically.

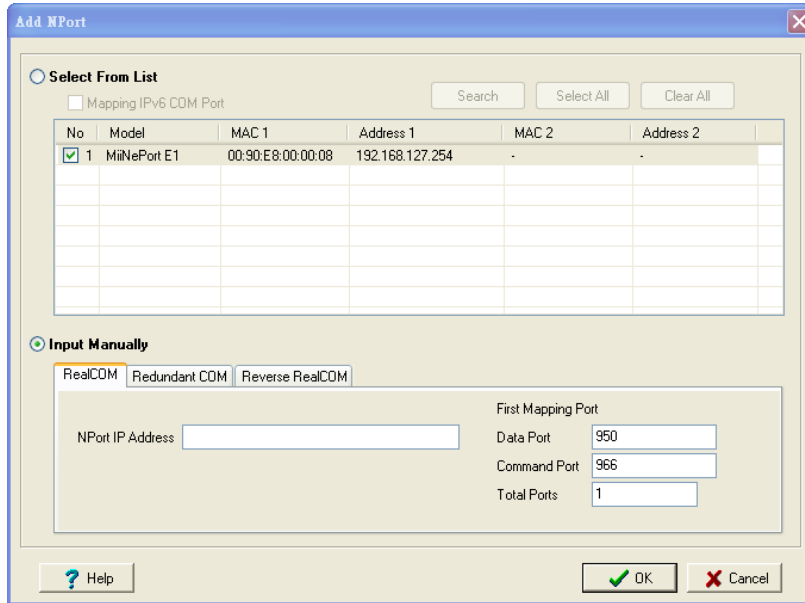

- COM ports and their mappings will appear in blue until they are activated. Activating the COM ports saves the information in the host system registry and makes the COM port available for use. The host computer will not have the ability to use the COM port until the COM ports are activated. Click **Yes** to activate the COM ports or click **No** to activate the COM ports later.

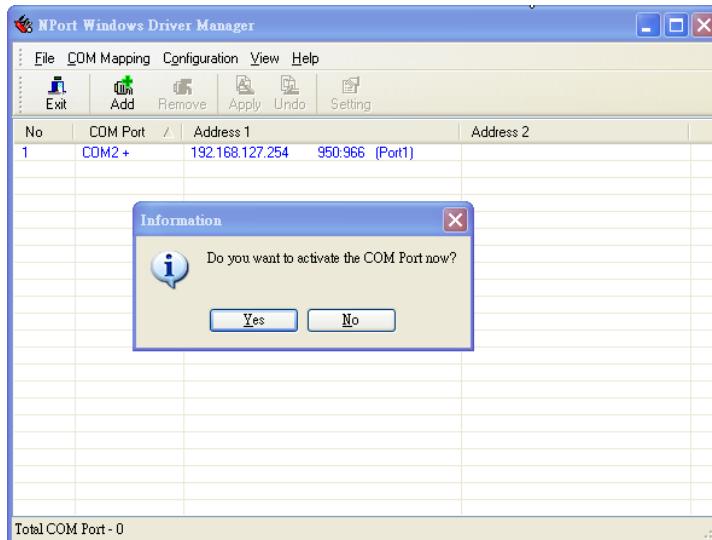

- Ports that have been activated will appear in black.

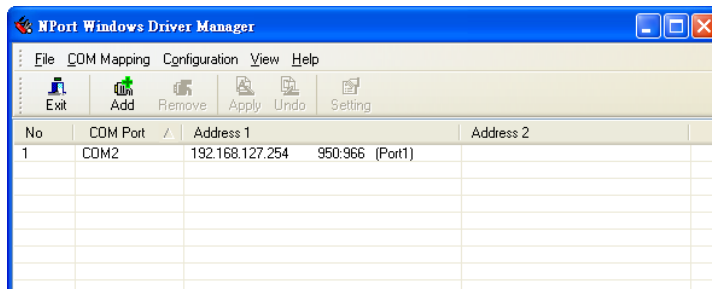

Command Line Installation/Removal

The NPort Windows Driver Manager v1.19 and above comes with command-line script tool – **npcli.exe** for installation, removal of the driver, and configuring NPort driver functions.

After successfully installing the NPort Windows Driver Manager v1.19 (or above), the default file path is **C:\Program Files\NPortDrvManager** as shown below. The main files that support the NPort command-line tool are **npcli.exe** and **GIdMap.dat**. You may move these two files to your preferred location.

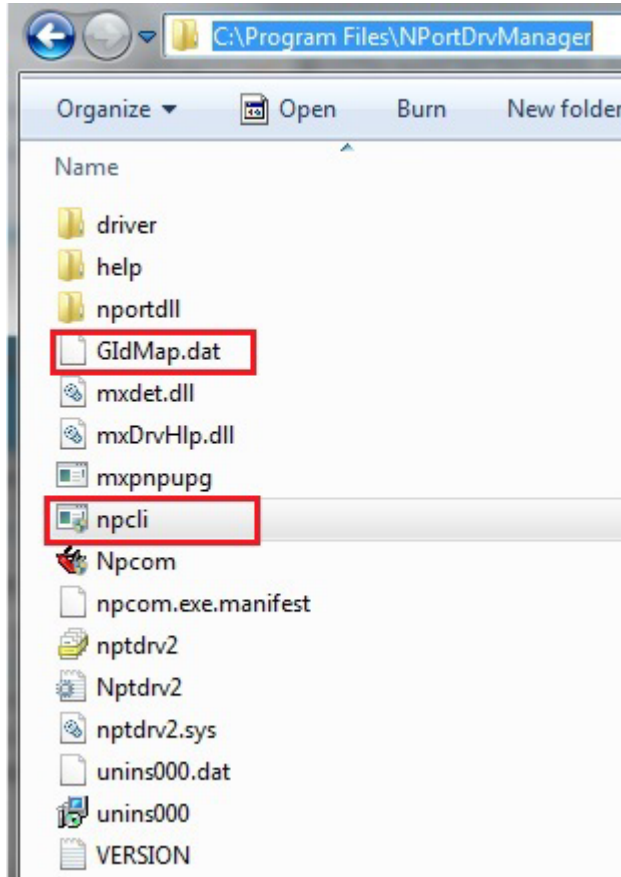

Once the NPort Windows Driver Manager v1.19 (or above) is installed, call up the **cmd** screen on your computer. Change the directory to the drive where you placed the above two files.

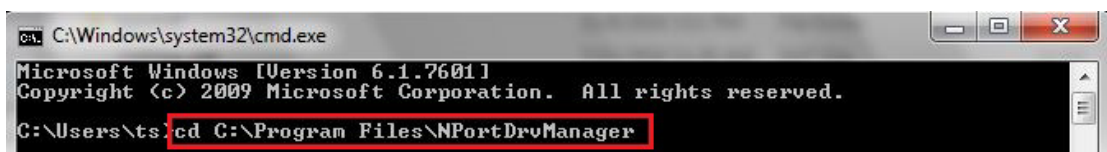

Type **npcli /?** to get detailed information of what command lines are supported and the function descriptions.

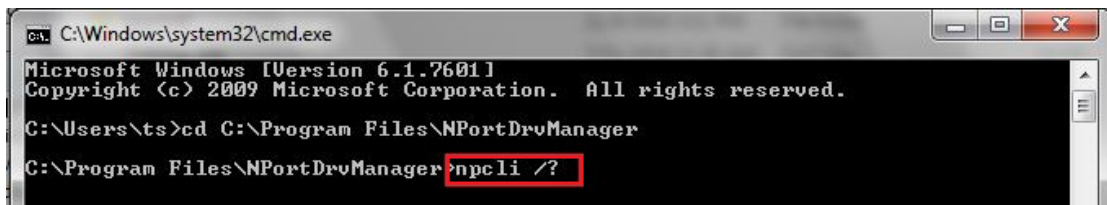

The usage instructions will show up for your reference.

```
-----  
NPort Command-Line Interface Ver2.0 Build 16052400  
-----  
Usage:  
  
1. NPort Driver operation:  
   npcli /driver [/install | /uninstall | /upgrade] [PATH_NAME]  
  
/install      Install specified driver to host.  
/uninstall    Uninstall current installed driver from host.  
/upgrade      Upgrade specified driver without modifying the mapped ports.  
PATH_NAME     Specify the installer file of NPort Driver Manager to install  
              or upgrade.  
  
2. RealCOM port operation:  
   npcli /driver /add IP_ADDR /port PORT_NO /com COM_NO [/txmode [hiperf |  
               classical]] [/fifo [enable | disable]] [/flush [fast | normal]]  
   npcli /driver /remove /com [COM_NO | all]  
  
/add          Add a RealCOM with a valid IP address (IP_ADDR).  
/port        Specify the NPort port number (PORT_NO) to add.  
/com         Specify the COM number to add or remove (COM_NO).  
/txmode      Set the TX mode as hi-performance (hiperf) or classical. The  
             default is hiperf.  
/fifo        Set the FIFO as enable or disable. The default is enable.  
/flush       Set to enable fast flush(fast) or disable fast flush(normal).  
             The default is fast.  
/remove      Remove specified COM number (COM_NO) or all RealCOM ports.  
  
3. NPort devices operation:  
   npcli /device /search  
   npcli /device /set ID /network [/ip IP_ADDR] [/mask SUBNET]  
   [/gateway IP_ADDR] [/password CIPHER]  
   npcli /device /apply ID [/password CIPHER]  
  
/search      Search the NPort and store the list to the memory.  
/set         Specify the ID to set. Users must specify one of the searched  
             NPorts for further operations. The default is 1.  
/port        Specify the NPort port number (PORT_NO) to set.  
/password    Specify the password (CIPHER) if the NPort has one.  
/network     Set to change the network settings.  
/ip          Change the IP address (IP_ADDR) of NPort.  
/mask        Change the subnet mask (SUBNET) of NPort.  
/gateway     Change the IP address (IP_ADDR) of gateway.  
/apply       Specify the ID to save changes and restart the NPort.  
  
4. Examples  
   npcli /driver /install D:\Users\drvMgr_setup_Ver1.19.0_Build_15122492  
   npcli /driver /uninstall  
   npcli /driver /add 192.168.127.254 /port 1 /com 3  
   npcli /driver /add 192.168.127.254 /port 2 /com 4 /flush normal  
   npcli /device /search  
   npcli /device /set 1 /network /ip 192.168.10.7 /mask 255.255.255.0  
   /password moxa  
   npcli /device /apply 1  
  
Note:  
Npcli.exe requires an administrator privilege to change device settings.  
It support only IPv4 and it must be run under Windows XP and later versions.
```

Linux Real TTY Drivers

Real TTY drivers are provided to map Linux host TTY ports to MiiNePort serial (TTL) ports. Once the mapping has been set up, Linux users and applications can connect to a serial (TTL) port as if it were a local TTY port. These drivers have been designed and tested for most Linux distributions, including Linux kernel version 2.4.x, 2.6.x and 3.0.x, 4.x. Please check Moxa's website (<http://www.moxa.com>) for the latest Linux kernel support. For more detail, please refer to README.TXT.

Installing Linux Real TTY Driver Files

1. Obtain the driver file from Moxa's website, at <http://www.moxa.com>.
2. Log in to the console as a superuser (root).
3. Execute **cd /** to go to the root directory.
4. Copy the driver file **npreal2xx.tgz** to the / directory.
5. Execute **tar xvzf npreal2xx.tgz** to extract all files into the system.
6. Execute **/tmp/moxa/mxinst**.
For RedHat AS/ES/WS and Fedora Core1, append an extra argument as follows:
/tmp/moxa/mxinst SP1
The shell script will install the driver files automatically.
7. After installing the driver, you will see several files in the **/usr/lib/npreal2/driver** folder:
 - **mxaddsvr** (Add Server, mapping TTY port)
 - **mxdelsvr** (Delete Server, un-mapping TTY port)
 - **mxloadsvr** (Reload Server)
 - **mxmknod** (Create device node/tty port)
 - **mxrmnod** (Remove device node/tty port)
 - **mxuninst** (Remove TTY port and driver files)

At this point, you will be ready to map the MiiNePort E1 serial port to the system TTY port.

Mapping TTY Ports

Make sure that you set the operation mode of the serial port of the MiiNePort E1 to RealCOM mode. After logging in as a superuser, enter the directory **/usr/lib/npreal2/driver** and then execute **mxaddsvr** to map the target MiiNePort E1 serial port to the host TTY ports. The syntax of **mxaddsvr** is as follows:

mxaddsvr [MiiNePort E1 IP Address] [Total Ports] ([Data port] [Cmd port])

The **mxaddsvr** command performs the following actions:

1. Changes npreal2d.cf.
2. Creates TTY ports in directory /dev with major and minor number configured in npreal2d.cf.
3. Restarts the driver.

Mapping TTY ports automatically

To map TTY ports automatically, you may execute **mxaddsvr** with just the IP address and number of ports, as in the following example:

```
# cd /usr/lib/npreal2/driver
# ./mxaddsvr 192.168.3.4 16
```

In this example, 16 TTY ports will be added, all with IP 192.168.3.4, with data ports from 950 to 965 and command ports from 966 to 981.

Mapping TTY ports manually

To map TTY ports manually, you may execute **mxaddsvr** and manually specify the data and command ports, as in the following example:

```
# cd /usr/lib/npreal2/driver
# ./mxaddsvr 192.168.3.4 16 4001 966
```

In this example, 16 TTY ports will be added, all with IP 192.168.3.4, with data ports from 4001 to 4016 and command ports from 966 to 981.

Removing Mapped TTY Ports

After logging in as root, enter the directory **/usr/lib/npreal2/driver** and then execute **mxdelsvr** to delete a server. The syntax of **mxdelsvr** is:

```
mxdelsvr [IP Address]
```

Example:

```
# cd /usr/lib/npreal2/driver
# ./mxdelsvr 192.168.3.4
```

The following actions are performed when executing **mxdelsvr**:

1. Changes **npreal2d.cf**.
2. Removes the relevant TTY ports in directory **/dev**.
3. Restart the driver.

If the IP address is not provided in the command line, the program will list the installed servers and total ports on the screen. You will need to choose a server from the list for deletion.

Removing Linux Driver Files

A utility is included that will remove all driver files, mapped TTY ports, and unload the driver. To do this, you only need to enter the directory **/usr/lib/npreal2/driver**, and then execute **mxuninst** to uninstall the driver. This program will perform the following actions:

1. Unload the driver.
2. Delete all files and directories in **/usr/lib/npreal2**.
3. Delete directory **/usr/lib/npreal2**.
4. Change the system initializing script file.

UNIX Fixed TTY Drivers

A fixed TTY driver is provided that will map UNIX host TTY ports to the MiiNePort. Once the mapping has been set up, UNIX users and applications can connect to a device port as if it were a local TTY port. This driver has been designed and tested for most UNIX systems. Please check Moxa's website (<http://www.moxa.com>) for the latest UNIX systems support. For more detail, please refer to README.TXT.

Installing the UNIX Driver

Log in to UNIX and create a directory for the Moxa TTY. To create a directory named **/usr/etc**, execute the command:

```
# mkdir -p /usr/etc
```

Copy **moxattyd.tar** to the directory you created. For the **/usr/etc** directory, execute the following commands:

```
# cp moxattyd.tar /usr/etc
# cd /usr/etc
```

Extract the source files from the tar file by executing the command:

```
# tar xvf moxattyd.tar
```

The following files will be extracted:

```
README.TXT
moxattyd.c --- source code
moxattyd.cf --- an empty configuration file
Makefile --- makefile
VERSION.TXT --- fixed TTY driver version
FAQ.TXT
```

Compile and link.

For SCO UNIX:

```
# make sco
```

For UnixWare 7:

```
# make svr5
```

For UnixWare 2.1.x, SVR4.2:

```
# make svr42
```

Configuring the UNIX Driver

Change the configuration:

The configuration used by **moxattyd** is defined in the text file **moxattyd.cf**, which is in the same directory. You may use vi or any text editor to change the file, as follows:

```
ttyp1 192.168.1.1 950
```

You can refer to **moxattyd.cf** for detailed descriptions of the various configuration parameters. Please note that "Device Name" depends on the OS. See the Device Naming Rule section in README.TXT for more information.

To start the **moxattyd** daemon after system boot-up, add an entry into **/etc/inittab** using the TTY name you defined in **moxattyd.cf**, as in the following example:

```
ts:2:respawn:/usr/etc/moxattyd/moxattyd -t 1
```

Device naming rule

For UnixWare 7, UnixWare 2.1.x, and SVR4.2, use:

```
pts/[n]
```

For all other UNIX operating systems, use:

```
ttyp[n]
```

The value of [n] should be equal or larger than 11 in order to prevent conflicts with the device names of functional keys in some UNIX systems.

Starting moxattyd

Execute the command **init q** or reboot your UNIX operating system.

Adding an additional server

Change the text file **moxattyd.cf** to add an additional server. User may use vi or any text editor to change the file. For more configuration information, refer to **moxattyd.cf**, which contains detailed descriptions of the various configuration parameters.

Find the process ID (PID) of the **moxattyd**.

ps -ef | grep moxattyd

Update the configuration of **moxattyd**.

kill -USR1 [PID]

(e.g., if moxattyd PID = 404, **kill -USR1 404**)

This completes adding an additional server.

5. MiiNePort IDE Development Tool

Installing MiiNePort IDE

Eclipse is an open source community, whose projects are focused on building an open development platform comprising extensible frameworks, tools and runtimes for building, deploying, and managing software across the lifecycle. MOXA provides an Eclipse-based integrated software development tool and a step-by-step source-level debugger, which is called MiiNePort IDE. The following instructions explain how to install Eclipse.

1. The SDK setup file can be downloaded from the MiiNePort's product page on Moxa's website:

MiiNePort-SDK_Setup_[Version]_build_[DateTime].exe

2. You will be greeted by the Welcome window. Click **Next** to continue.

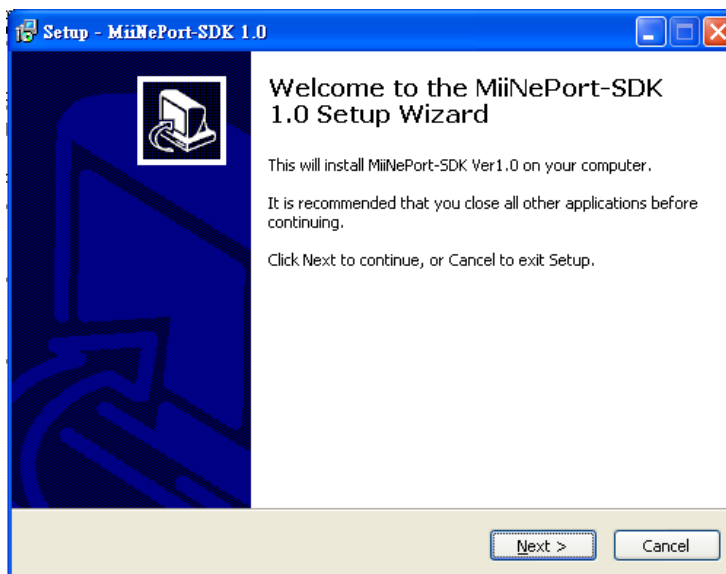

3. Next page is license agreement. Select **I accept the agreement**, then click **Next**.

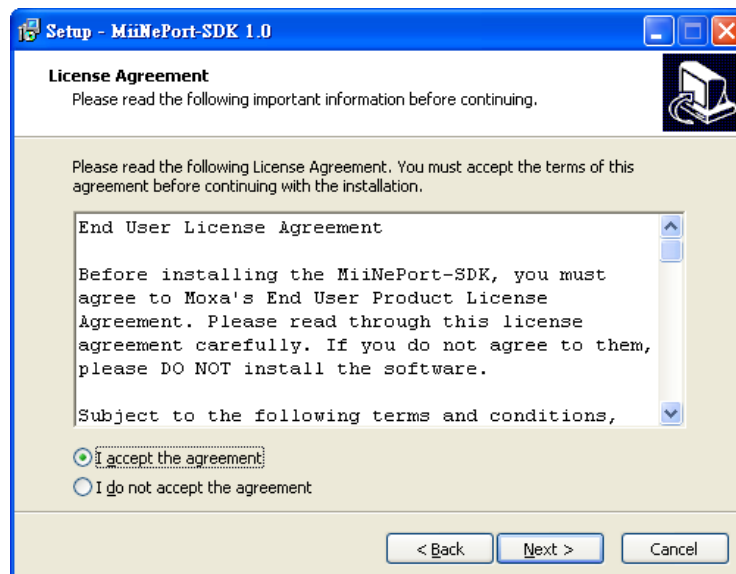

- When the Select Destination Location window appears, click **Next** to continue. You may change the destination directory by first clicking on **Browse...**

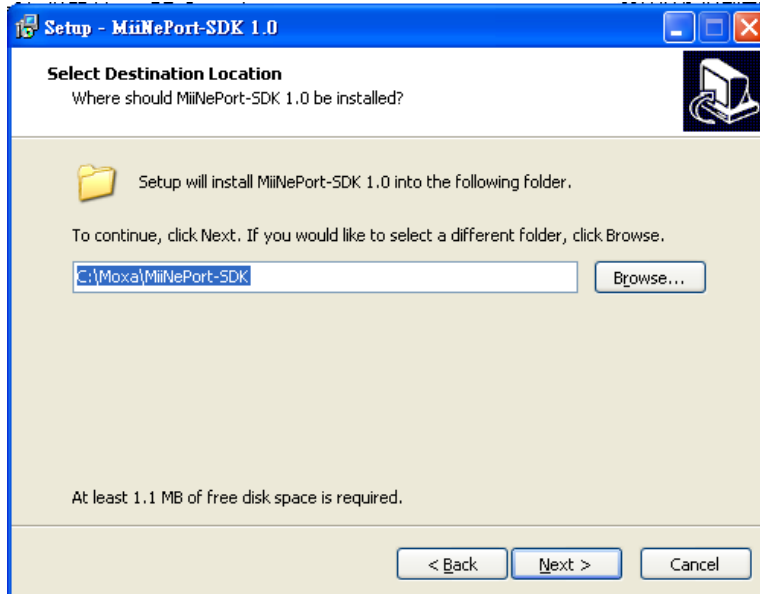

- In this page, you can select what components you would like to install, then click **Next**.

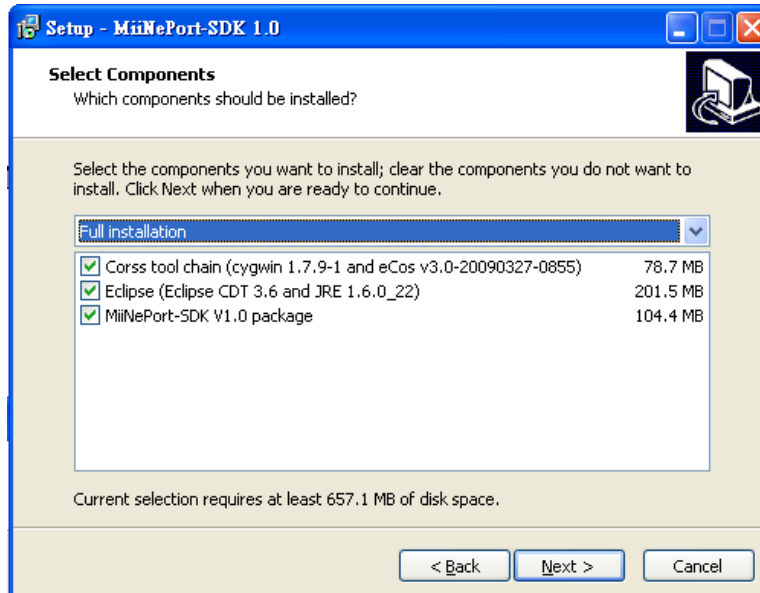

- Then creating the program's shortcuts. When the Select Destination Location window appears, click **Next** to continue. You may change the destination directory by first clicking on **Browse...**

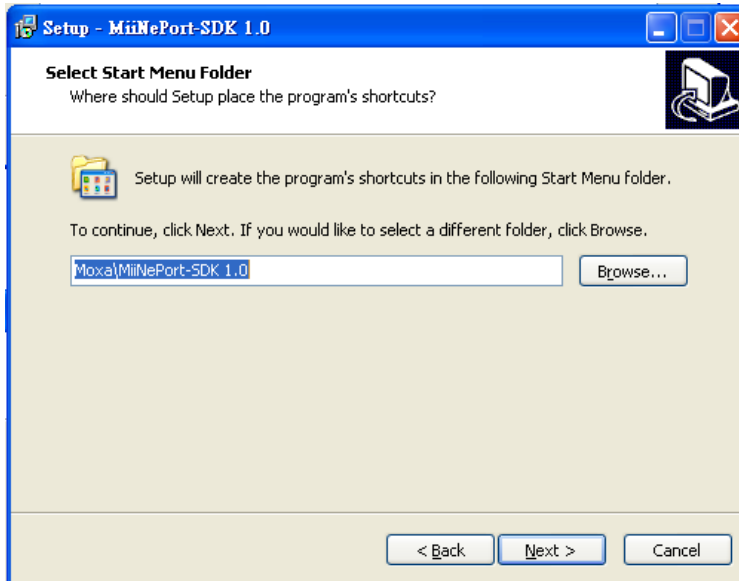

- Click **Next** to copy the software files.

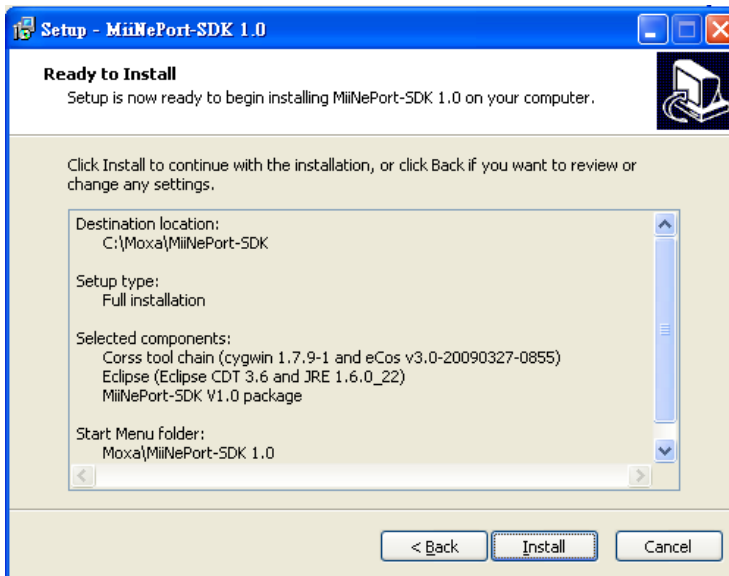

8. A progress bar will appear. The procedure should take only a few seconds to complete.

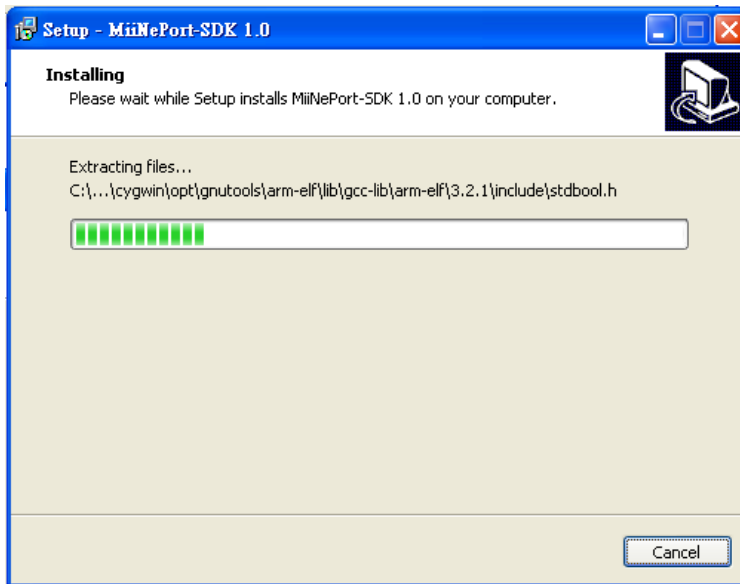

9. A message will show that MiiNePort IDE is successfully installed.

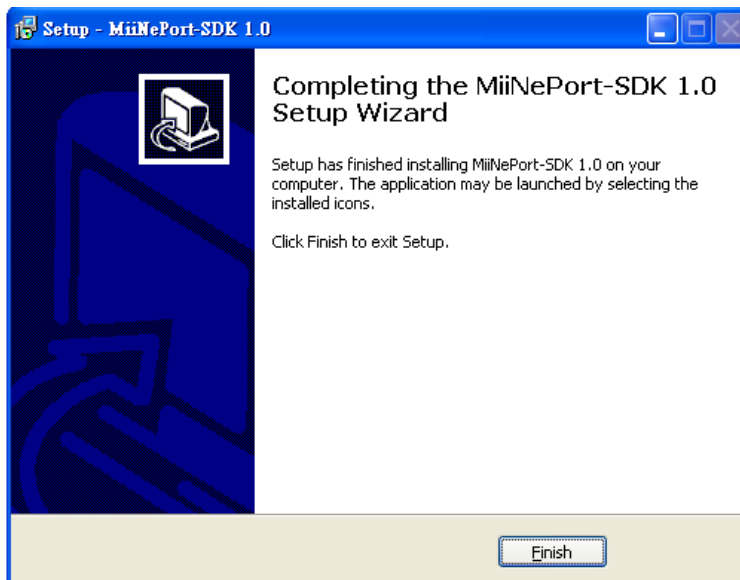

10. You may also open MiiNePort IDE through **Start → Programs → MOXA → MiiNePort-SDK → MiiNePort-IDE**, as shown below.

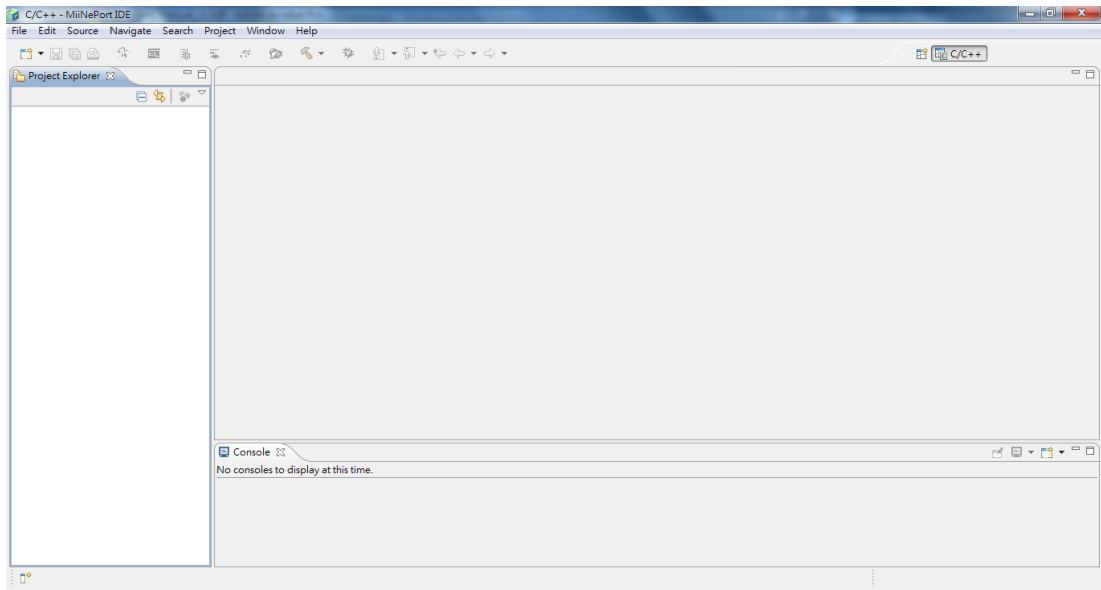

Starting MiiNePort IDE

MiiNePort IDE is an Eclipse-based integrated software development tool and a step-by-step source-level debugger that is used to configure the MiiNePort-SDK.

Before running MiiNePort IDE, make sure that the MiiNePort-SDK device is connected to your PC. Please refer to Chapter 2 for more details.

You may open MiiNePort IDE from the Windows Start menu by clicking **Start → Programs → MOXA → MiiNePort-SDK → MiiNePort-IDE**. The MiiNePort IDE window should appear as shown below.

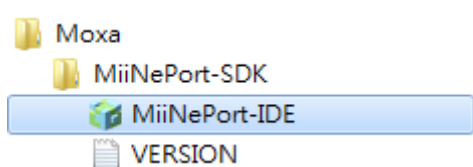

Create MiiNePort-SDK Project

Prior to firmware development, the MiiNePort-SDK device must be connected to the unit. For developing customized firmware, MOXA provides a powerful tool called **EZStack**. You can compose the desired functions step by step. The following section will show you how to build a customized firmware. First, create a new project by clicking **File → New → MiiNePort-SDK Project**.

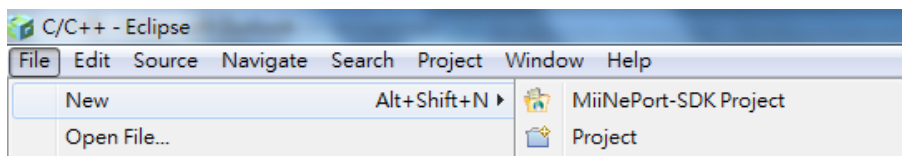

The project wizard will then begin, as shown in the figure below. Just fill your desired value into each field and click **Next** to continue. The description of each parameter is shown in the table below.

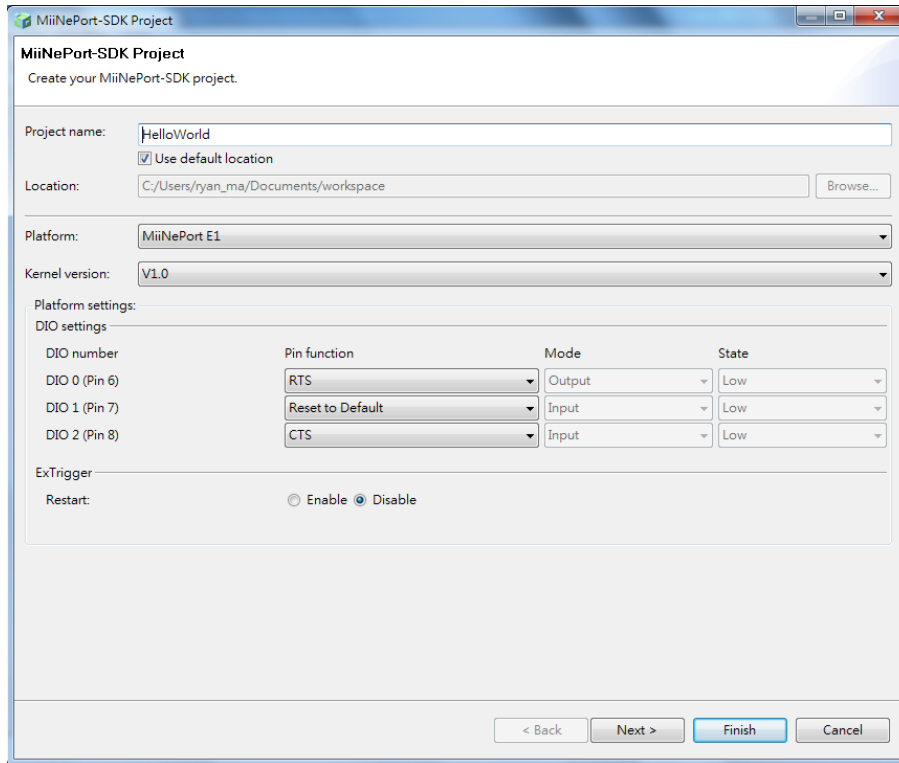

Parameter	Description
Project name	The project name
Location	The location path of project
Platform	The development platform 1. MiiNePort E1 2. MiiNePort E2
Kernel Version	SDK version

For MiiNePort E1-SDK

Parameter	Description
DIO	For the 3 configurable pins (Pin 6, 7, and 8), refer to Chapter 1: Pin Assignments for their default settings and change to the appropriate function for your application.
Restart	The restart function is enabled by default and is not subject to be disabled. You can choose to enable or disable the Restart function in the Pin and IO Settings.

EXTrigger provides an easy tool for network troubleshooting without interrupting device operation.

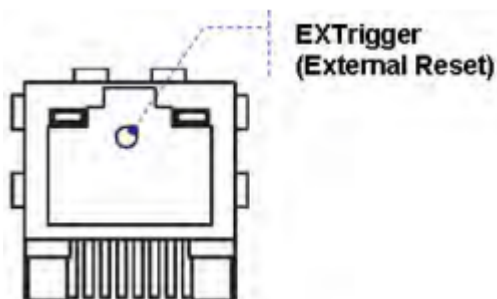

For MiiNePort E2-SDK

Parameter	Description
DIO	<p>Mode Select Input or Output under Mode to specify digital input or digital output operation.</p> <p>State Select Low or High under State to specify a high or low state for digital output channels. Note that when Mode is set to Input (as shown in the above screenshot), the State option is deactivated.</p>

The next page is regarding serial to Ethernet application, data packing and serial command mode.

MiiNePort-SDK Project

Application Selection
Select an application to represent your target device.

Serial to Ethernet application: RealCOM Mode

Port setting

TCP alive check time: 7 (0-99 min)

Max. connection: 1

Ignore jammed IP: Enable Disable

Allow driver control: Enable Disable

Data packing

Packet length: 0 (0 - 1024)

Delimiter 1: 00 (Hex) Enable

Delimiter 2: 00 (Hex) Enable

Delimiter process: Do nothing

Force transmit: 0 (0-65535ms)

Serial command mode

Enable SCM mode

Port number: PORT1

SCM trigger mode: SW Trigger

1st character: 58 (Hex)

2nd character: 58 (Hex)

3rd character: 58 (Hex)

HW DIO: DIO0

DIO trigger mode: HW_LOW

Boot up timeout: 3000 (ms)

< Back Next > Finish Cancel

RealCOM Mode

Serial to Ethernet application: RealCOM Mode



ATTENTION

To use RealCOM mode, refer to Chapter 4: **Utility Console and Driver Installation** to install the RealCOM driver on Windows or Linux.

Port setting

TCP alive check time: 7 (0-99 min)

Max. connection: 1

Ignore jammed IP: Enable Disable

Allow driver control: Enable Disable

TCP alive check time

Setting	Factory Default	Recommended Setting
0 to 99 min	7 min	Optional

0 min: The TCP connection is not closed because of an idle TCP connection.

1 to 99 min: The module automatically closes the TCP connection if there is no TCP activity for the given time.

After the connection is closed, the module listens for another host's TCP connection.

Max connection

Setting	Factory Default	Recommended Setting
1, 2, 3, 4	1	Required

Max connection is used when the device needs to receive data from different hosts simultaneously.

The factory default only allows 1 connection at a time. When Max Connection is set to 1, the RealCOM driver on the specific host has full control.

Max connection 1: The module will only allow one host's RealCOM driver to open a connection to the module's serial port.

Max connection 2 to 4: When set to two or higher, RealCOM drivers for up to the specified number of hosts may open this port at the same time. When RealCOM drivers for multiple hosts open the port, the COM driver only provides a pure data tunnel with no control ability. The serial port parameters will use firmware settings instead of your application program (AP) settings.

Application software that is based on the COM driver will receive a driver's response of "success" when the software uses any of the Win32 API functions. The firmware will only send data back to the driver on the host. Data will be sent first-in, first-out when data is received by the MiiNePort E1 from the Ethernet interface.



ATTENTION

When Max connection is greater than one, the MiiNePort E1 module will use a multiple connection application (i.e., two to four hosts are allowed access to the port at the same time). When using a multi-connection application, the module will use the serial communication parameters as defined in the web console, and all hosts connected to the port must use identical serial settings. If one host opens the COM port with different serial settings, data will not be transmitted properly.

Ignore jammed IP

Setting	Factory Default	Recommended Setting
Enable, Disable	Disable	Required when Max connection greater than 1

This option determines how the port will proceed if multiple hosts are connected and one or more of the hosts stops responding as the port is transmitting data. If you select Disable, the port will wait until the data has been transmitted successfully to all hosts before transmitting the next group of data. If you select Enable, the port will ignore the host that stopped responding and continue data transmission to the other hosts.



NOTE

Ignore Jammed IP is only valid when the Max connection is greater than 1.

Allow driver control

Setting	Factory Default	Recommended Setting
Enable, Disable	Disable	Required when Max connection greater than 1



NOTE

Allow drive control is only valid when Max connection is greater than 1.

This option determines how the port will proceed if driver control commands are received from multiple hosts that are connected to the port. If Disable is selected, driver control commands will be ignored. If Enable is selected, control commands will be accepted, with the most recent command received taking precedence.

Ethernet Modem Mode

Serial to Ethernet application: Ethernet Modem Mode

TCP alive check time

Setting	Factory Default	Recommended Setting
0 to 99 min	7 min	Optional

0 min: The TCP connection is not closed because of an idle TCP connection.

1 to 99 min: The module automatically closes the TCP connection if there is no TCP activity for the given time.

After the connection is closed, the module listens for another host's TCP connection.

TCP Port

Setting	Factory Default	Recommended Setting
1 to 65535	4001	Required

Use this field to show the TCP port the module will use to listen to connections, and that other devices must use to contact the module. To avoid conflicts with well-known TCP ports, the default is set to 4001

Sample Application

Serial to Ethernet application:

Sample application:

Application description:

TCP Client Any Character

Acts as a TCP client. Connects to Host PC when serial port receives any character and performs data transmission between the serial and ethernet.

Setting	Factory Default	Recommended Setting
TCP Client Any Character	TCP Client Any Character	Optional
TCP Client Ask Destination		
TCP Client Echo		
TCP Client Startup		
TCP Server Echo		
TCP Server Multiple Connections		
TCP Server Single Connection		
UDP Echo		
UDP Mode		

TCP Client Any Character: Acts as a TCP client. Connects to Host PC when serial port receives a character and performs serial-to-Ethernet data transmissions.

TCP Client Ask Destination: Acts as a TCP client. Connects to Host PC after destination IP is got via serial port and then performs data transmission between the serial and Ethernet.

TCP Client Echo: Acts as a TCP client. Connects to Host PC and echoes all the received data to server.

TCP Client Startup: Acts as a TCP client. Connects to Host PC on startup and performs data transmission between the serial and Ethernet.

TCP Server Echo: Acts as a TCP server. Accepts connection and echoes all the received data to client.

TCP Server Multiple Connections: Acts as a TCP server. Accepts multiple connections and performs data transmission between the serial and Ethernet.

TCP Server Single Connection: Acts as a TCP server. Accepts single connection and performs data transmission between the serial and Ethernet.

UDP Echo: Creates a UDP socket and echoes the data received from the Ethernet port.

UDP Mode: Creates a UDP socket and performs data transmission between the serial port and Ethernet port.

Data Packing

Data packing

Packet length: (0 - 1024)

Delimiter 1: (Hex) Enable

Delimiter 2: (Hex) Enable

Delimiter process: ▼

Force transmit: (0-65535ms)

Packet length

Setting	Factory Default	Recommended Setting
0 to 1024 bytes	0 byte	Required

The Packet length setting refers to the maximum amount of data that is allowed to accumulate in the serial port buffer before sending. At the default of 0 for packet length, no maximum amount is specified and data in the buffer will be sent as specified by the delimiter settings or when the buffer is full. When a packet length between 1 and 1024 bytes is specified, data in the buffer will be sent as soon as it reaches the specified length.

Delimiter 1

Setting	Factory Default	Recommended Setting
00 to FF	"0" for None	Optional

Delimiter 2

Setting	Factory Default	Recommended Setting
00 to FF	"0" for None	Optional

The delimiter fields are used to specify a character or two-character sequence which will act as a marker to control packing of serial data. By default, no delimiter characters are defined, so the module transmits data as soon as it is received. When a delimiter character or characters are defined, the module will hold data in its buffer until it receives the delimiter character or two-character sequence. When the delimiter is received, the module will pack up the data in its buffer and send it through the Ethernet port.

Use Delimiter 1 to define the first delimiter character in hex. If only one delimiter character will be used, Delimiter 2 should be set to "0". If the delimiter will be a two-character sequence, use Delimiter 2 to define the second character. To disable the use of delimiters, set both Delimiter 1 and Delimiter 2 to "0".

Note that data packing is not only controlled by the delimiter; it is also influenced by the module's buffer size and the Force transmit field. If the delimiter has not been received by the time the 1K buffer is full, the module will pack the data for network transmission and clear the buffer. Also, if the module will also pack data for network transmission if the next byte of data is not received within the Force transmit time.

Match bytes

Setting	Factory Default	Recommended Setting
1 byte to 2 bytes	2 bytes (only effective when Delimiter is enabled)	Optional

1 byte: MiiNePort E1 packs the serial data and sends out TCP/IP packets once it receives either Delimiter 1 or Delimiter 2.

2 bytes: MiiNePort E1 only packs the serial data and sends out TCP/IP packets once it receives both of Delimiter 1 and Delimiter 2. And the receiving order should be first Delimiter 1 then Delimiter 2.

Delimiter process

Setting	Factory Default	Recommended Setting
Do Nothing, Delimiter+1, Delimiter+2	Do Nothing (only effective when Delimiter is enabled)	Optional

The delimiter process field determines how the data is handled when a delimiter is received. Delimiter 1 must be enabled for this field to have an effect. If Delimiters 1 and 2 are both enabled, both characters must be received for the delimiter process to take place.

Do Nothing: Data in the buffer will be transmitted when the delimiter is received.

Delimiter + 1: Data in the buffer will be transmitted after one additional byte is received following the delimiter.

Delimiter + 2: Data in the buffer will be transmitted after two additional bytes are received following the delimiter.

Force transmit

Setting	Factory Default	Recommended Setting
0 to 65535 ms	0 ms	Optional

0: The force transmit timeout is disabled.

1 to 65535: If the module does not receive the next byte of data within the time specified, it will pack the data in its buffer into the same data frame for network transmission.

The **Force transmit** field is typically used with the delimiter fields to specify how data in the module’s buffer is packed for network transmission. When delimiters are used, the module accumulates data in its buffer as it waits to receive a delimiter. If there is a break in communication, data will be held in the buffer as the module continues to wait for a delimiter. The Force transmit field allows you to specify the maximum time that the module will wait for data. With Force transmit enabled, the module will automatically pack the data in the buffer for network transmission if no data is received for the specified time.

When set to 0, Force transmit is disabled, which means there is no time limit for how long the module will wait to receive data. When set between 1 and 65535, the module will pack data as soon as there is no serial communication for the specified time.

The optimal force transmit time depends on your application, but it should be larger than one character interval within the specified baud rate to have any effect. For example, assume that the serial port is set to 1200 bps, 8 data bits, 1 stop bit, and no parity. Here, the total number of bits needed to send one character is 10 bits, and the time required to transfer one character is

(10 bits / 1200 bits/s) × 1000 ms/s = 8.3 ms.

Since it requires about 9 ms to send one character, the Force transmit should be 10 ms or more to have any effect. At 9 ms or less, the module will simply pack every character as it is received, which would be the same as if no delimiter characters or Force transmit time were specified at all.

Serial Command Mode

SCM (Serial Command Mode) uses serial communication between the MiiNePort E1 and your device’s primary system to configure the MiiNePort E1, usually during device operation. For more details about SCM commands, refer to Chapter 6: **NetEZ Technologies**.

Port number

Setting	Factory Default	Recommended Setting
Port 1	Port 1	Optional

SCM trigger mode

Setting	Factory Default	Recommended Setting
HW trigger		
SW trigger	SW trigger	Optional
Bootup SW trigger		
Break trigger		

HW trigger: Entering the SCM mode by HW DIO and DIO trigger mode.

SW trigger: Entering the SCM mode by the continuous three characters. The default value is 0x58, 0x58, 0x58

Bootup SW trigger: Entering the SCM mode by the continuous three characters during the timeout period. The default value is 0x58, 0x58, 0x58

Break trigger: Break signals are caused by sending continuous Spacing values (no Start or Stop bits). When there is no electricity present on the data circuit, the line is sending a Break. The Break signal must be of duration longer than the time to send a complete byte plus Start, Stop, and Parity bits.

The Next page is network settings, you can assign IP configuration in this page.

The screenshot shows a window titled "MiiNePort-SDK Project" with a "Network Settings" dialog box. The dialog contains the following fields:

- Device name: MiiNePort-SDK
- IP configuration: Static (dropdown menu)
- IP address: 192.168.127.254
- Netmask: 255.255.255.0
- Gateway: (empty text box)
- DNS server 1: (empty text box)
- DNS server 2: (empty text box)

At the bottom of the dialog, there are four buttons: "< Back", "Next >", "Finish", and "Cancel".

Device name

Setting	Factory Default	Recommended Setting
1 to 40 characters	[model name]_[Serial No.]	Optional

This option can specify the location or application of the module, which may be useful when managing more than one module on the network.

IP configuration

Method	Function Definition
Static	User defined IP address, Netmask, Gateway.

Method	Function Definition
DHCP	DHCP Server assigned IP address, Netmask, Gateway, DNS
BOOTP	BOOTP Server assigned IP address

IP configuration is a required field. The default setting is Static.



ATTENTION

In Dynamic IP environments, the module will attempt to get an IP address from the DHCP or BOOTP server three times at 30-second intervals. The timeout for the first try will be 1 second, the second try will be 3 seconds, and the last try will be 5 seconds.

If the DHCP/BOOTP Server is unavailable, the module will use the default IP address (192.168.127.254), netmask, and gateway settings.

IP Address

Setting	Factory Default	Recommended Setting
E.g., 192.168.1.1 (IP addresses of the form x.x.x.0 and x.x.x.255 are invalid.)	192.168.127.254	Required

An IP address is a number assigned to a network device, such as a computer, as a permanent address on the network. Computers use the IP address to identify and talk to each other over the network. Choose a proper IP address that is unique and valid in your network environment.

Netmask

Setting	Factory Default	Recommended Setting
E.g., 255.255.255.0	255.255.255.0	Required

A subnet mask represents all the network hosts at one geographic location, in one building, or on the same local area network. When a packet is sent out over the network, the module will use the subnet mask to check whether the host specified in the packet is on a local network segment. If the address is on the same network segment as the module, a connection is established directly from the module. Otherwise, the connection is established through the default gateway.

Gateway

Setting	Factory Default	Recommended Setting
E.g., 192.168.1.1	None	Optional

A gateway acts as an entrance to another network. Usually, the computers that control traffic within the network or at the local Internet service provider are gateway nodes. The module needs to know the IP address of the default gateway computer in order to communicate with the hosts outside the local network environment. For the correct gateway IP address information, consult your network administrator.

DNS server 1 / DNS server 2

Setting	Factory Default	Recommended Setting
E.g., 192.168.1.1 (IP addresses of the form x.x.x.0 and x.x.x.255 are invalid)	None	Optional

Domain Name System (DNS) is how Internet domain names are identified and translated into IP addresses. A domain name is an alphanumeric name, such as moxa.com, that it is usually easier to remember. A DNS server is a host that translates the text-based domain name into the corresponding numeric IP address which is used to establish a TCP/IP connection. When the user enters a website address, the computer asks a DNS server for the website's IP address to connect to the web server.

When a DNS server is specified, the module acts as DNS client and will allow domain names instead of IP addresses to be used on the web console. The following web console fields support the use of domain names: TCP Client-Destination IP Address, and IP Address Report Server. Two DNS servers may be specified, DNS server 1 and DNS server 2. DNS server 2 is included for use when DNS server 1 is unavailable.

The Next page is about serial parameters settings, all serial parameters settings can be adjusted in this page.

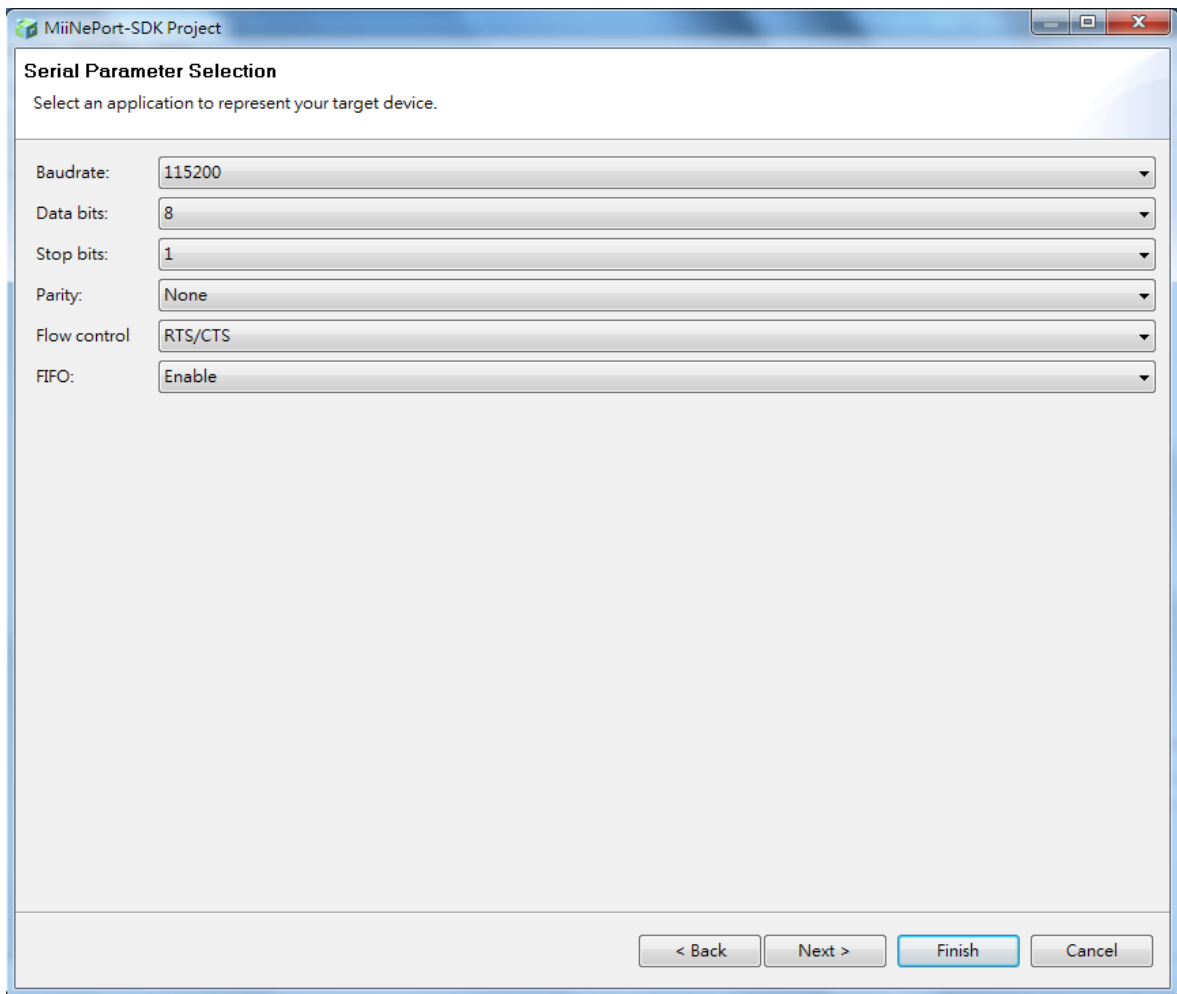

Baudrate

Setting	Factory Default	Recommended Setting
50 bps to 921.6 Kbps	115200	Required

IP configuration is a required field. The default setting is Static.



ATTENTION

Baudrate 460800 and 921600 are for high-speed models only. If you don't want to use high-speed mode, please remove the jumper first.

Data Bits

Setting	Factory Default	Recommended Setting
5, 6, 7, 8	8	Required

Stop Bits

Setting	Factory Default	Recommended Setting
1, 1.5, 2	1	Required

Stop Bits will be set to 1.5 when Data Bits is set to 5 bits.

Parity

Setting	Factory Default	Recommended Setting
None, Even, Odd, Space, Mark	None	Required

Flow control

Setting	Factory Default	Recommended Setting
None, RTS/CTS, DTR/DSR, XON/XOFF	RTS/CTS	Required

FIFO

Setting	Factory Default	Recommended Setting
Enable, Disable	Enable	Required

Each module's serial port provides a 16-byte FIFO both in the Tx and Rx directions. Disable the FIFO setting when your serial device does not have a FIFO to prevent data loss during communication.

MOXA provides a lot of applications to customers; if you check the checkbox, the desired application will be applied in your customized firmware.

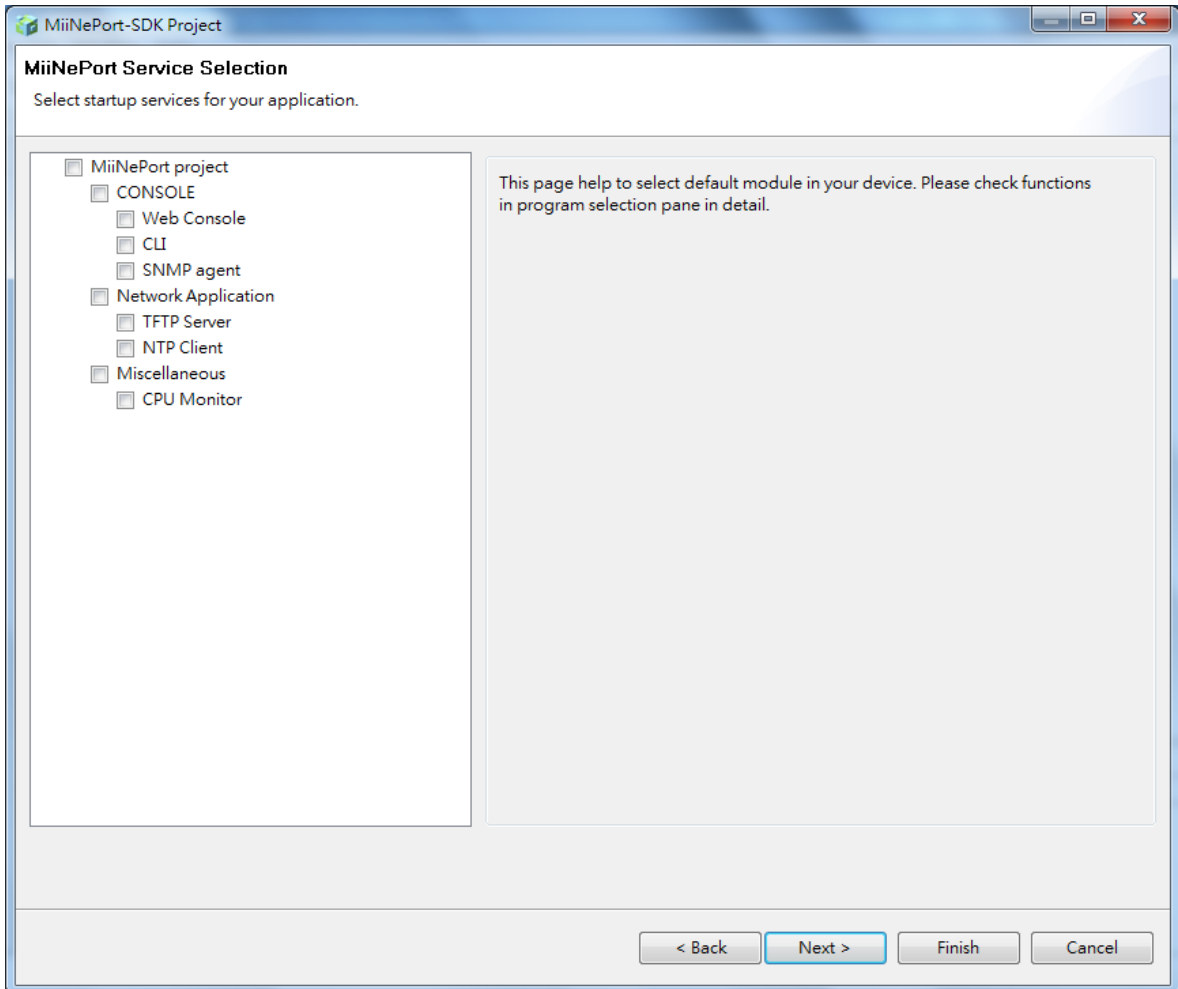

Web Console

The Web Console is the most user-friendly way to configure the MiiNePort device. We use the Web Console interface to introduce the functions. There are only a few differences between the Web Console and Serial Console.

Default settings	
HTTP port:	<input type="text" value="80"/> (0~65535)
Connections:	<input type="text" value="5"/> (>0)
Session timeout:	<input type="text" value="300"/> sec (0~65535)
Keep-Alive timeout:	<input type="text" value="25"/> sec (0~65535)

HTTP port

Setting	Factory Default	Recommended Setting
0~65535	80	Required

Connections

Setting	Factory Default	Recommended Setting
>0	5	Required

Session timeout

Setting	Factory Default	Recommended Setting
0~6553	300	Required

Keep-Alive timeout

Setting	Factory Default	Recommended Setting
0~65535	25	Required

CLI

For Telnet/serial console access, MiiNePort device provides Command-Line Interface (CLI) to do some configuration or monitor work of the device, such as network configuration, serial parameter configuration, etc. The programmer can build user-defined CLI by using system CLI APIs, and a function is provided to add the user-defined CLI to the command list. The project sample code provides a set of default CLI commands is for user to reference when developing new CLI or for modification to suit for the user application.

Default settings	
Telnet port:	<input type="text" value="23"/> (1~65535)

Telnet port

Setting	Factory Default	Recommended Setting
0~65535	23	Required

SNMP agent

SNMP (Simple Network Management Protocol) is an Internet standard for managing devices on IP networks. The SNMP comprises two kinds of devices, the managed device that is known as SNMP agent and the SNMP manager that controls the SNMP agent. MiiNePort will be the SNMP agent, which supports the SNMP V1 (Version 1) and V2 (Version 2).

SNMP version

Setting	Factory Default	Recommended Setting
V1, V2	V1, V2	Required

Read community

Setting	Factory Default	Recommended Setting
0 to 40 characters	public	Optional

A read community name is a plain-text password mechanism that is used to authenticate queries to agents of managed network devices.

Write community

Setting	Factory Default	Recommended Setting
0 to 40 characters	private	Optional

A write community name is a plain-text password mechanism that is used to authenticate queries to agents of managed network devices.

Description

Setting	Factory Default	Recommended Setting
0 to 40 characters	None	Optional

Contact

Setting	Factory Default	Recommended Setting
0 to 40 characters	None	Optional

The SNMP contact information usually includes an emergency contact name and telephone or pager number.

Name

Setting	Factory Default	Recommended Setting
0 to 40 characters	None	Optional

Location

Setting	Factory Default	Recommended Setting
0 to 40 characters	None	Optional

Enter a location string for SNMP agents. This string is usually set to the street address where the module is physically located.

Service

Setting	Factory Default	Recommended Setting
>=0	0	Optional

OID

Setting	Factory Default	Recommended Setting
0 to 256 characters	None	Optional



ATTENTION

For MIB wizard, it works after you create a project. Please refer to the **Wizards** section for more details.

TFTP Server

Trivial File Transfer Protocol (TFTP) is a file transfer protocol known for its simplicity. It is used for automated transfer of configuration or boot files between machines in a local environment.

NTP Client

NTP (Network Time Protocol) is a protocol for synchronizing the clocks of computer systems over packet-switched, variable-latency data networks. It is designed particularly to resist the effects of variable latency by using a jitter buffer. NTP uses the User Datagram Protocol (UDP) on port number 123. Please refer the official website for more information.

NTP Client Settings

Time server IP/name 1:

Time server IP/name 2:

Time offset: (-720 ~ 720 min)

Time server query period: sec (>30)

Time server IP/name 1/2:

Setting	Factory Default	Recommended Setting
0 to 40 characters	None	Required

Time offset:

Setting	Factory Default	Recommended Setting
-720~720 min	0	Optional

Time server query period:

Setting	Factory Default	Recommended Setting
>30	600	Optional

CPU Monitor

Enable this function to monitor status of the CPU.

The next page will display the result you select. Then click **Next** to create this project.

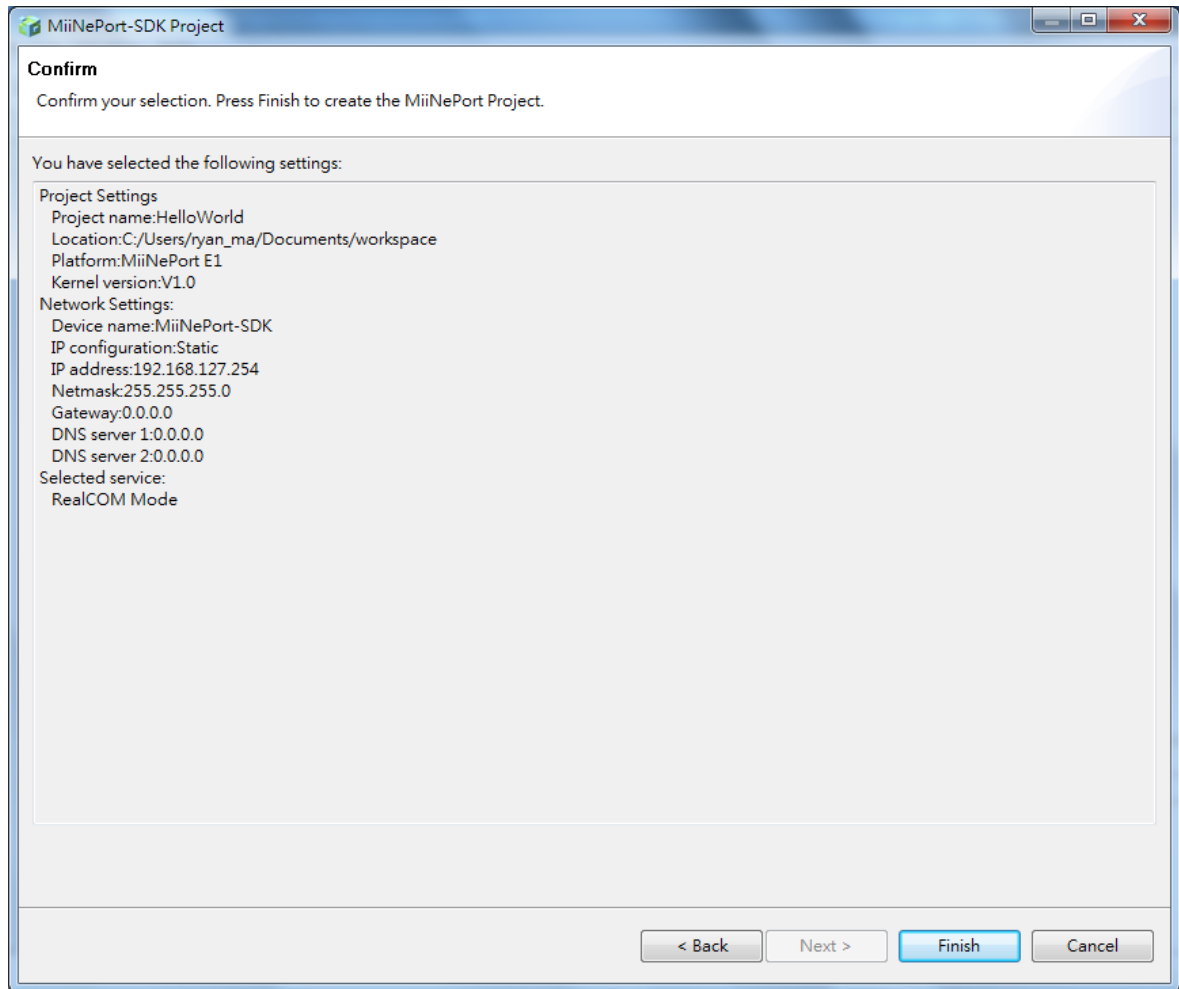

Finally, the project will be created on the project explorer list. Then you can change or add source code to develop your firmware.

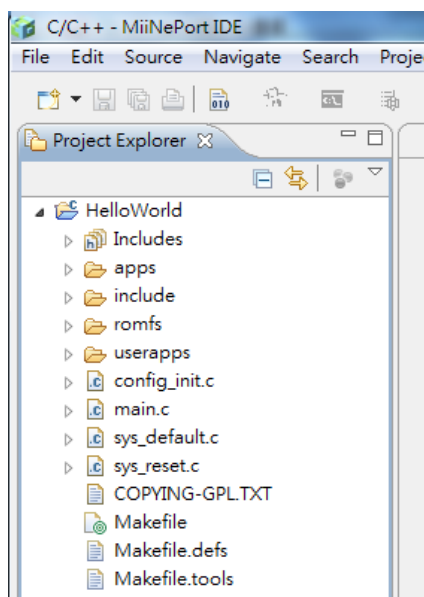

Wizards

Moxa provides wizards to help you change source codes. Then MiiNePort IDE can create the functions automatically. Below is the list of wizards (You can find it on the tool bar):

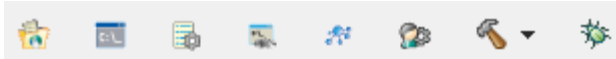

From the left to right, they are:

- CLI Wizard: Help to add CLI commands
- Configuration Wizard: Help to make configuration variables
- SCM Wizard: Help to add SCM command
- SNMP MIB Wizard Action: Help to add SNMP MIB
- User App Wizard: Help to create user application (subroutine)
- Project Wizard: Help to change function and property of project
- MiiNePort-SDK debug: Debug MiiNePort project
- Build: Release build and debug build (download firmware)

Change project dependency

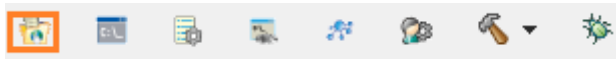

The function is used to change the settings of MiiNePort project. The section "Create MiiNePort-SDK Project" includes the description of all settings. Please refer the before section.

The following section will introduce more details about each wizard.

CLI Wizard

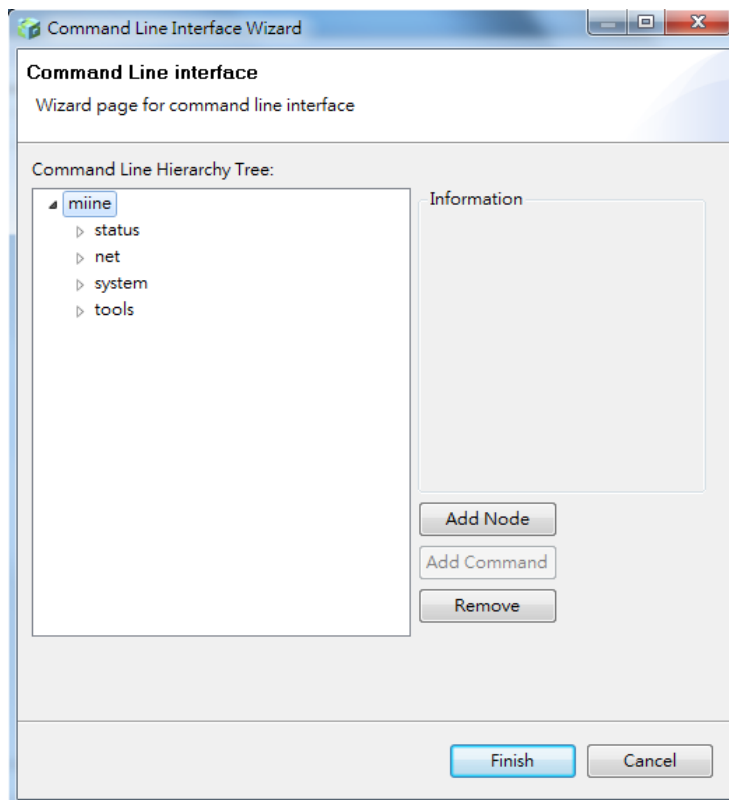
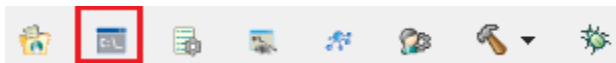

This wizard is used to add CLI command. The command-line interface is a tree structure, and each leaf is a command. You can do some configuration or monitor work of the device by these commands you define.

Select the location you want to add command.

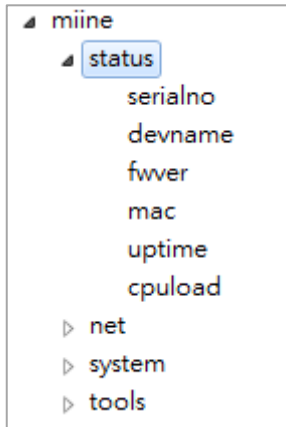

First, click **Add Node** to add a node.

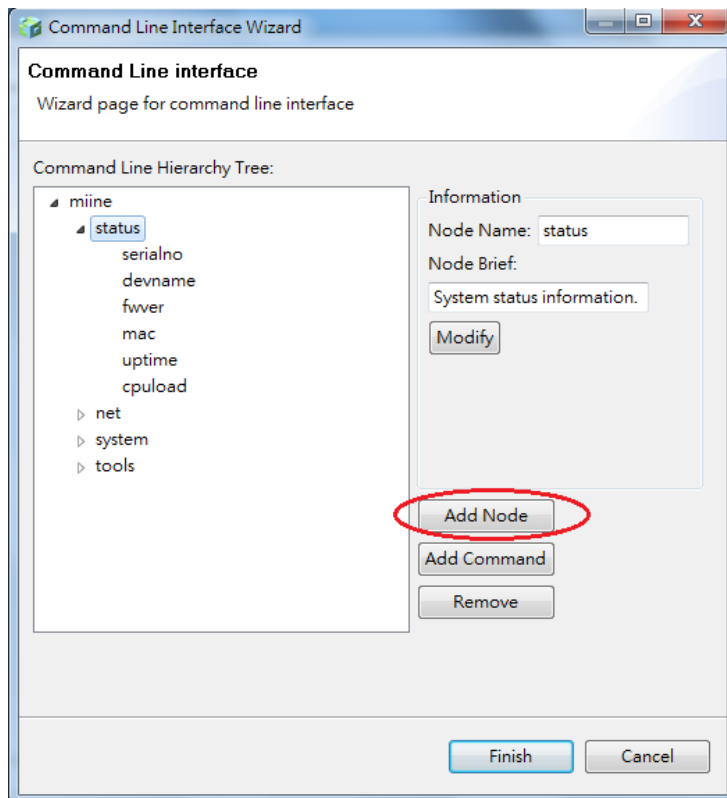

A window will pop up, you can edit node name and node brief. And then click the **Confirm** button.

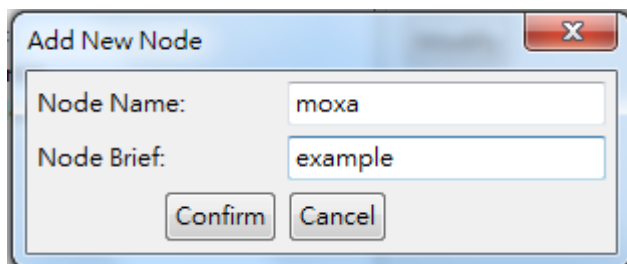

Then click **Add Command** to add a new command.

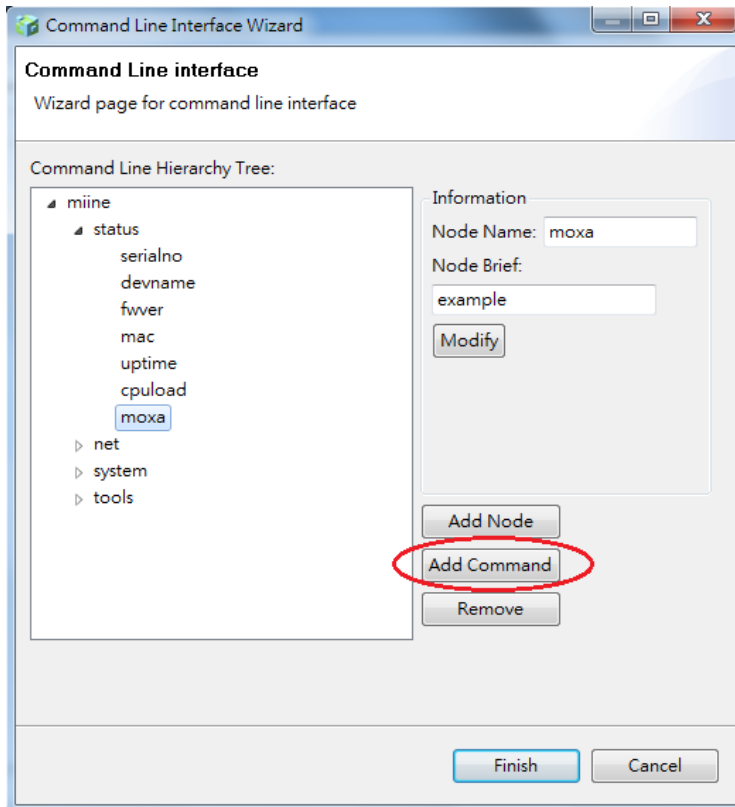

Then window will show up, and you have to enter Command Name, Function, and Node Brief. After you have filled in, click **Confirm**.

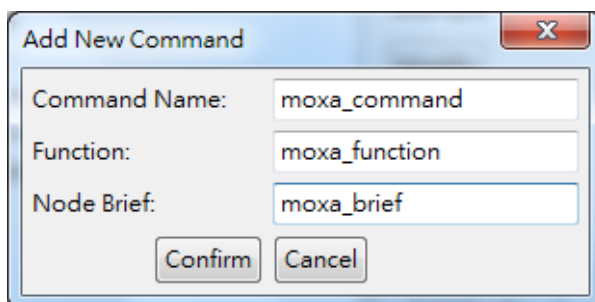

Then the new command is created. You can change and remove it. When you finish setting CLI, click the **Finish** button.

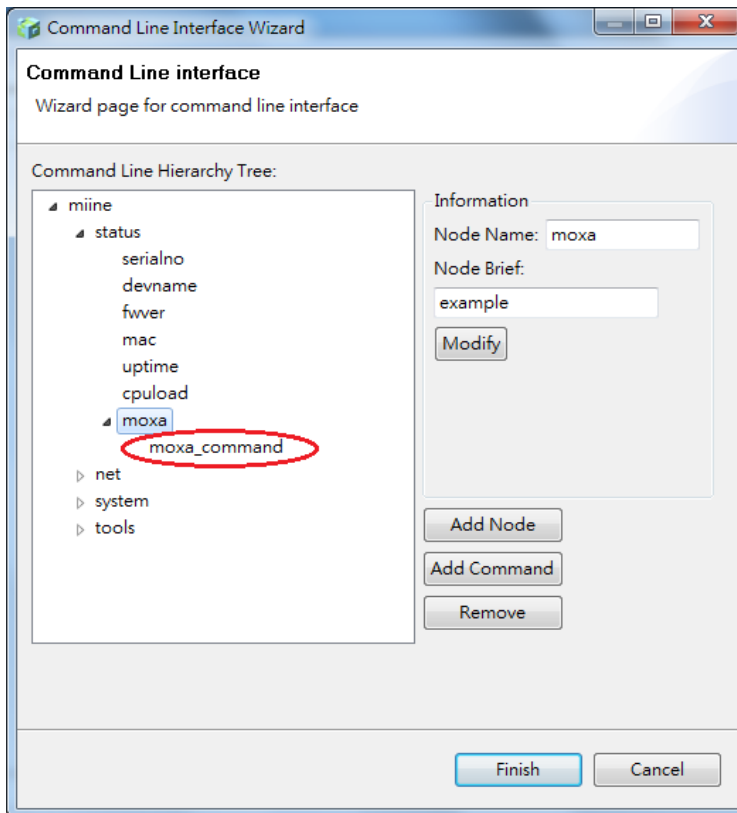

Then you can develop the behavior of this "moxa_command" in the moxa_function() in this example.

```
cliAddCmd("tools", "ping", ping_brief, cli_ping_function);  
cliAddCmd("moxa_node", "moxa_command", moxa_command_brief, moxa_function);
```

Configuration Wizard

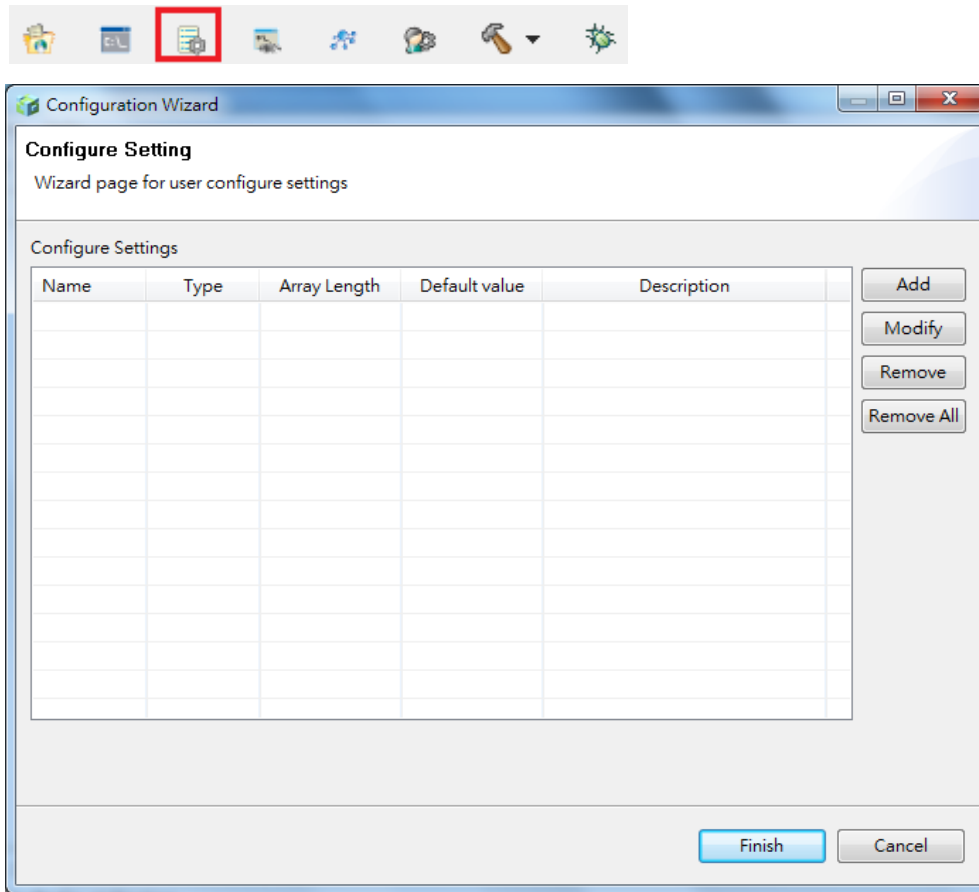

This wizard is used to help to make configuration variables. You can define the attribute you need in this page. This way, you can build up your own configuration.

SCM Wizard

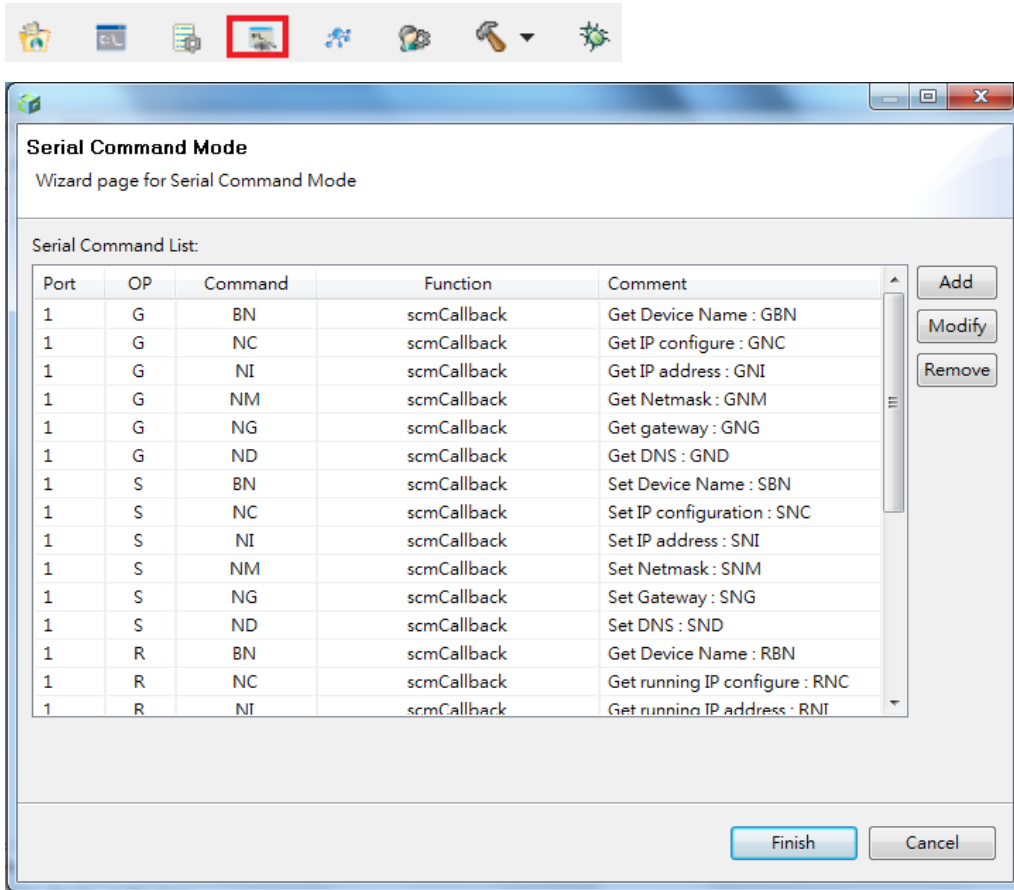

This wizard is used to help add SCM commands. You can add the serial command you need on this page. With these serial commands, you can configure your device to help add SCM commands.

Click **Add** button to add a new serial command. Regarding the format of serial command, please refer to Appendix A.

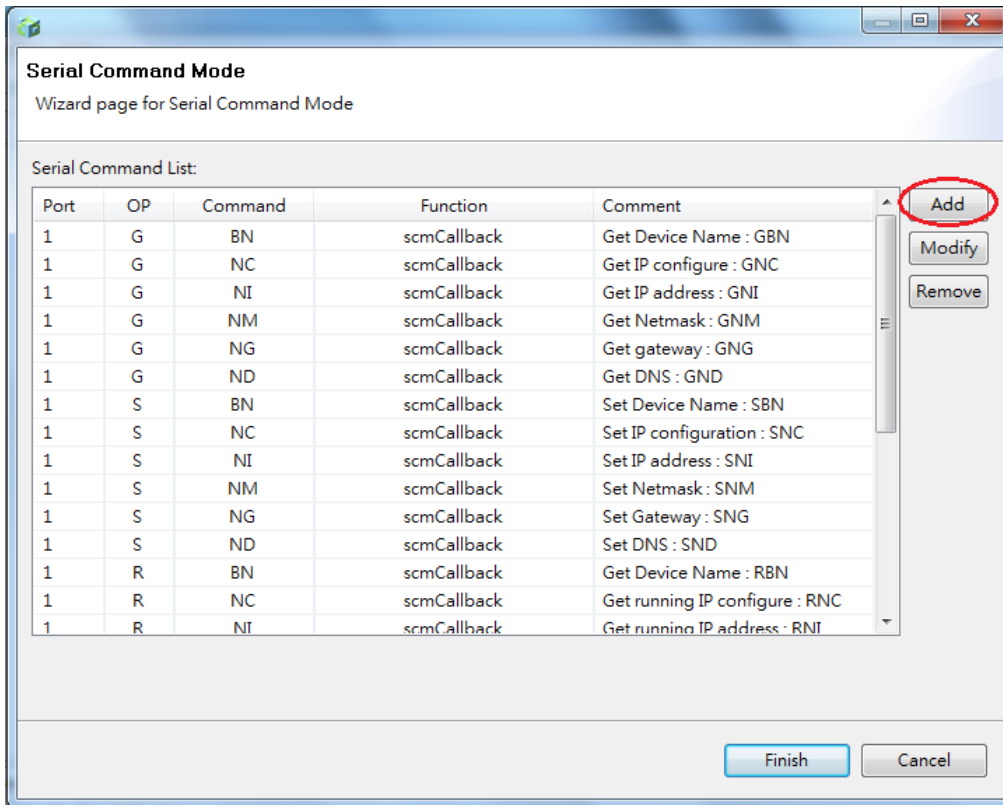

Then a serial command mode window will pop up. Fill in each field. Click **Confirm** to add a new serial command.

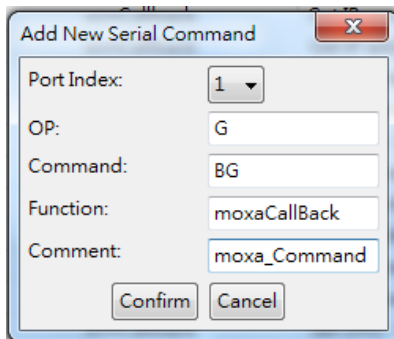

The result of all serial commands will be listed in the serial command list. Click **Finish** to apply your settings.

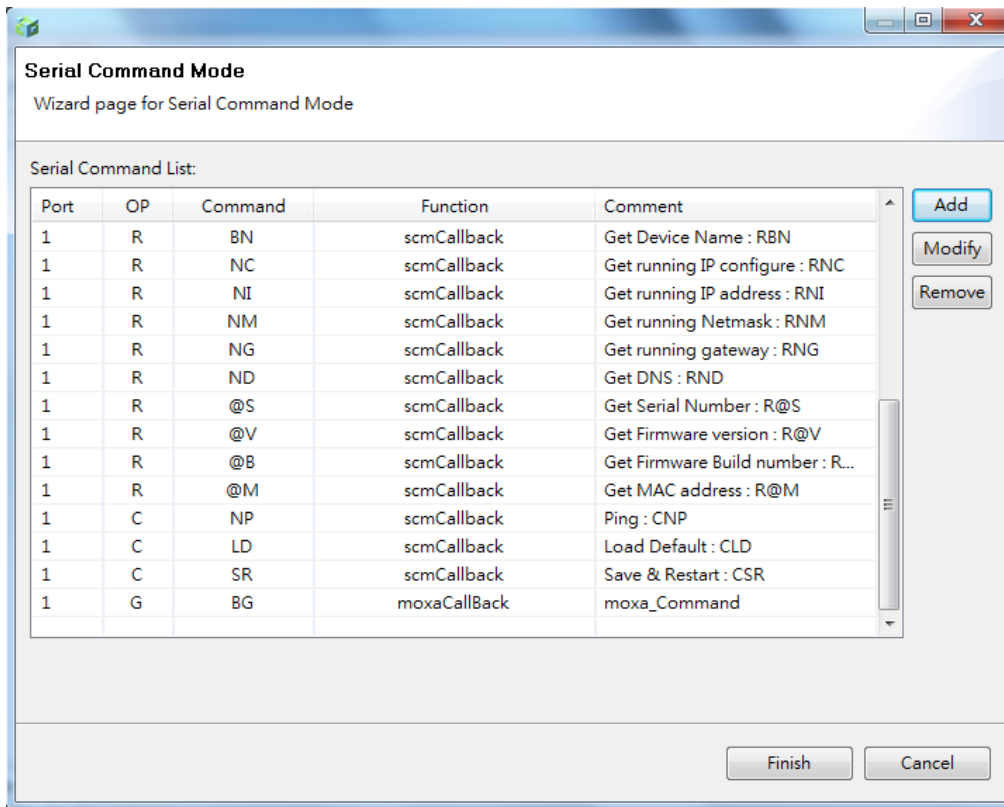

Finally, your command will be saved into scmcmd.c file. You can add other behavior to this method.

```
scmAddCmd(1, 'C', "LD", scmCallback); // Load Default : CLD
scmAddCmd(1, 'C', "SR", scmCallback); // Save & Restart : CSR
scmAddCmd(1, 'G', "BG", moxaCallback); // GetMoxaCfg:GBN
}
```

SNMP Wizard

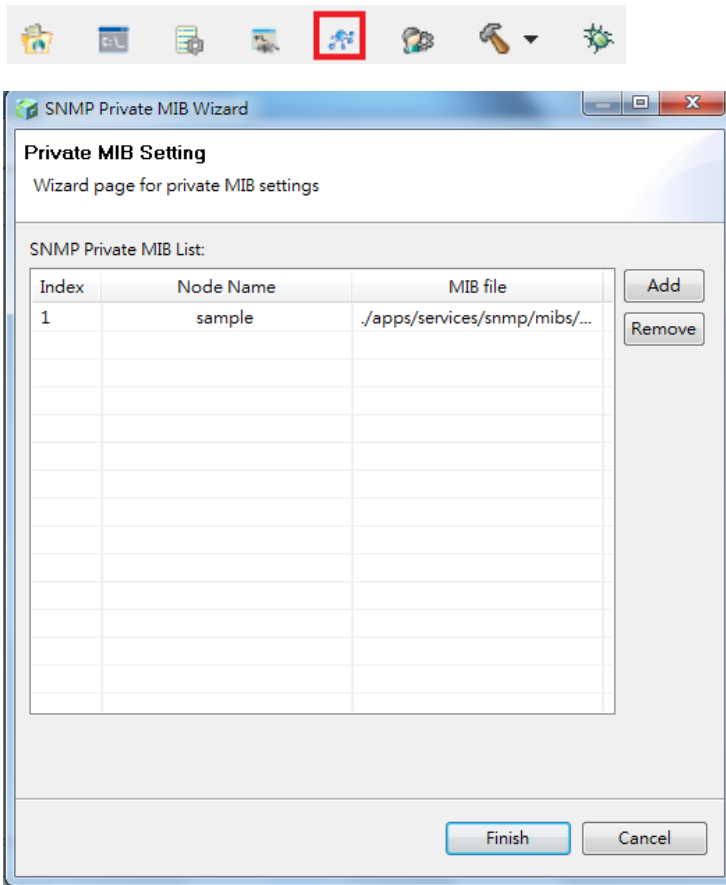

This wizard is used to help to add a private MIB. You can add the private MIB you need on this page. By these OIDs in private MIB, you can manage your device by SNMP protocol.



ATTENTION

For MIB wizard, a node has a max of 255 subnodes.

First, click **Add** button.

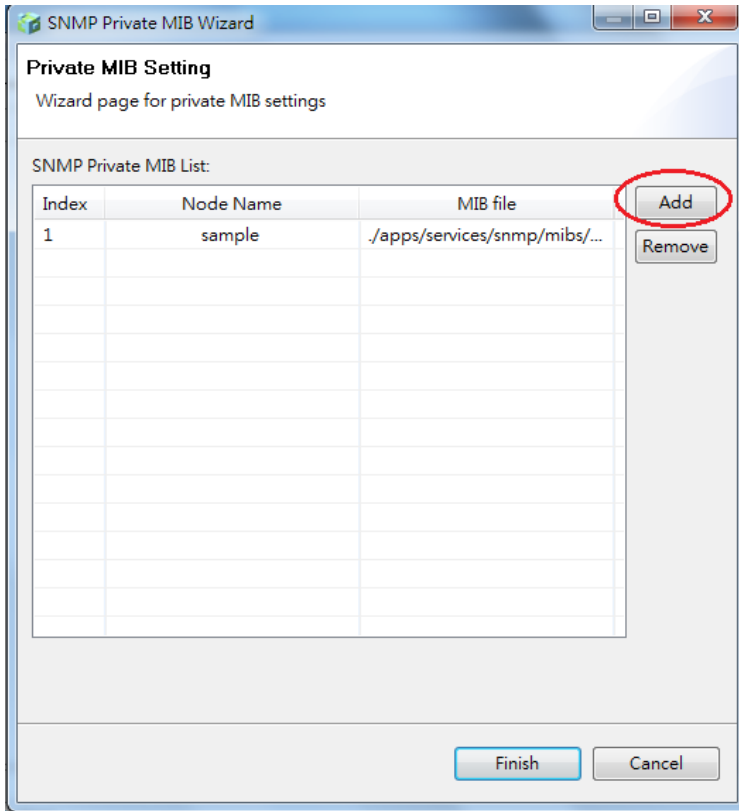

Select the private MIB by the **Browse** button and fill in this node name. After you have completed it, click **Confirm**.

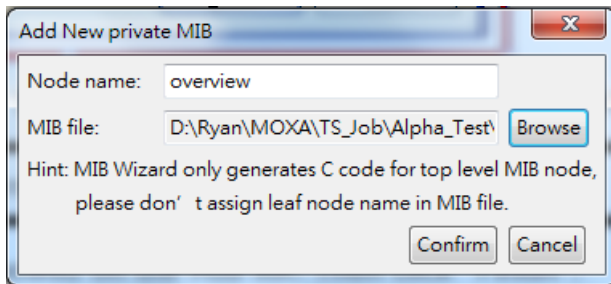

NOTE

Node name is the root name you would like to generate

User App Wizard

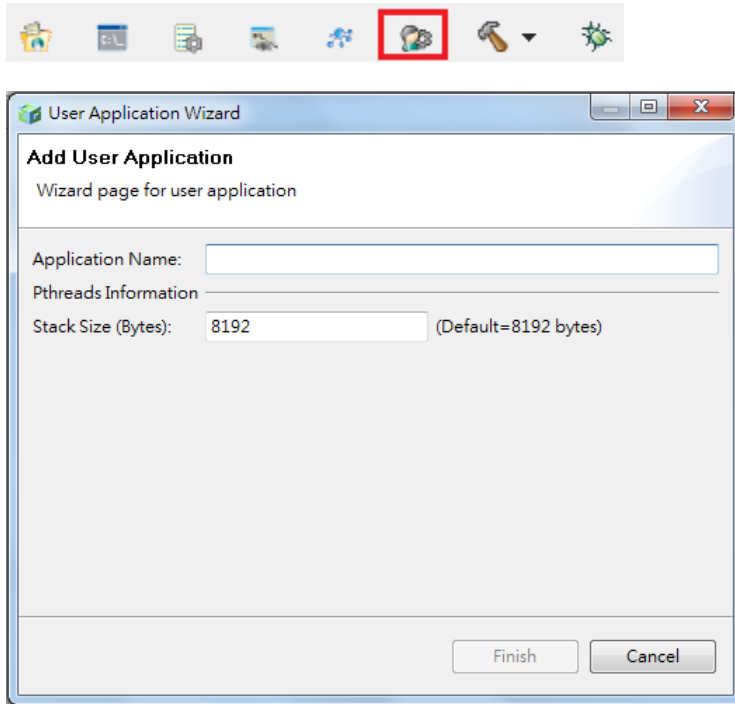

This wizard is used to help you create your application (subroutine). If you would like to develop your own application, you can use this wizard. It will show you how to add a new application.

Fill in all fields, click **Finish** button.

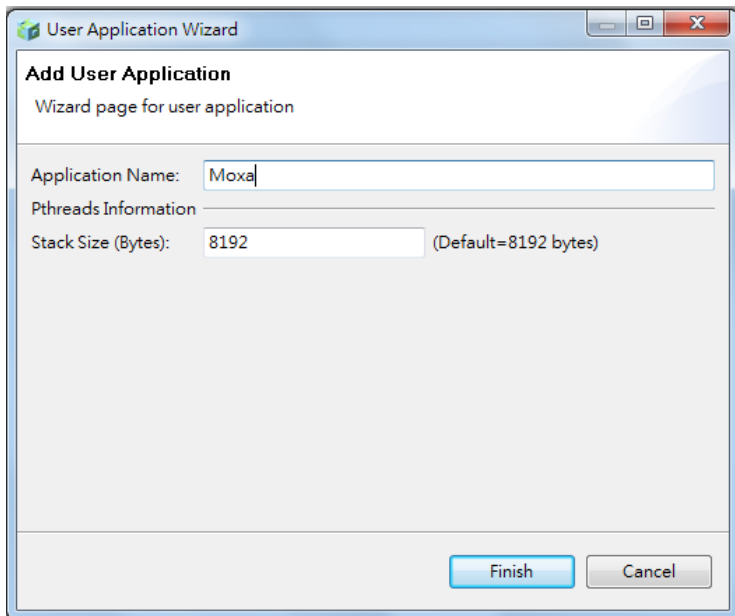

The file templates will be created, so you can develop your application with them.

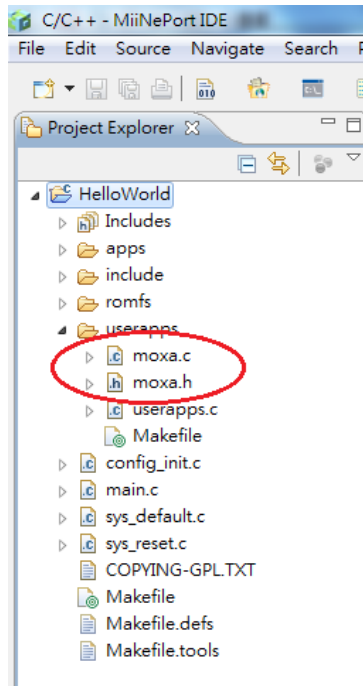

Build project

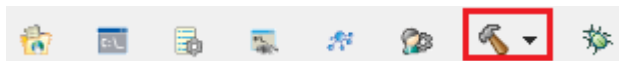

The function is used to build a customized firmware which you develop. This function can build two different firmware. If you select **debug** type, the firmware will be downloaded onto the MiiNePort. Then you can debug step by step. If you build release version firmware, it will generate a customized firmware without debug message. Besides, it will not write onto the MiiNePort, and you can upgrade it into the MiiNePort by utility.

Upload debug version firmware to MiiNePort

After compiling the source code, you must upload your debug firmware file to the MiiNePort to verify all functions. Moxa provides a source-level debug tool. In this way, you can debug it step by step to find your programming issues.

First, you need to build a debug firmware, and then the MiiNePort will create a folder, which is called "Debug," and put the firmware into this folder. Click the **debug** button to upload firmware onto the MiiNePort by a USB port automatically.

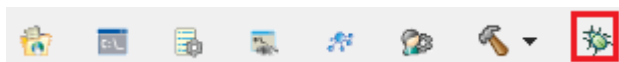

After uploading successfully, you can start to debug step by step.

Debug current active project



The function is used to debug a MiiNePort project. It will download your project in the MiiNePort SDK and then execute your project. In addition, if you set **break point**, you can debug step by step.

Upload your customized firmware to MiiNePort

After the development of your customized firmware has been completed, you must deploy your firmware file to the MiiNePort. Please remember to connect an Ethernet cable to the MiiNePort first, then use the NPort Search Utility, as it can help you upload your firmware to the MiiNePort easily.

First, you need to build a release firmware, then the MiiNePort IDE will ask you to confirm if you want to reset the default to MiiNePort device. Click **Yes** to go to the next step.

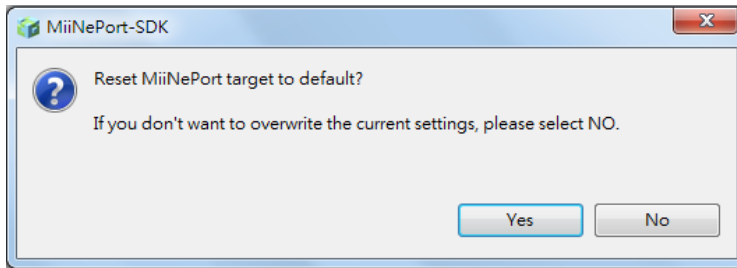

Then the MiiNePort will create a folder which is called "Release." Put the firmware into this folder, so that you can find your firmware in the sub-folder 'objs'.

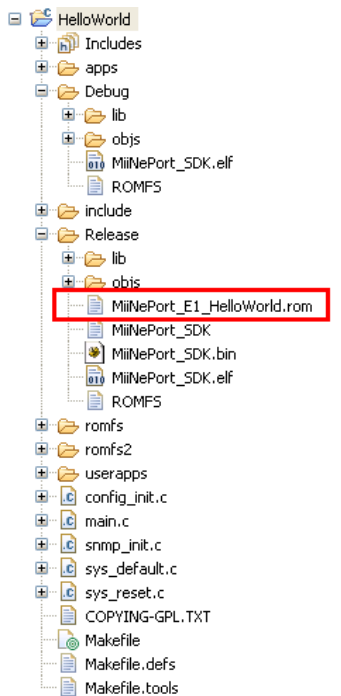

Please copy the .rom file to your desired path. In this way, you can upgrade the firmware by the Device Search utility.



Select the target devices and the firmware you saved in the desired path, then click **OK** to upload the firmware to the MiiNePort devices via Ethernet.

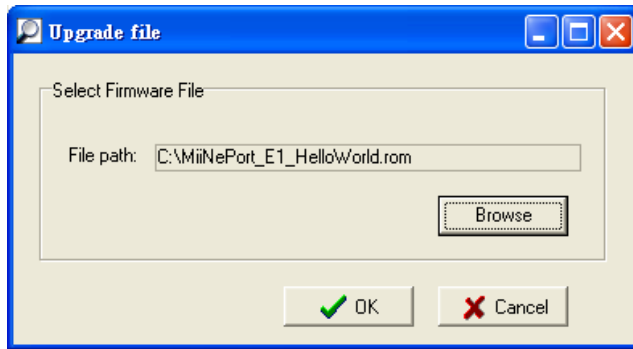

After uploading it successfully, the MiiNePort devices will be updated with all the new firmware.



ATTENTION

For E1, user can upgrade MiiNePort SDK firmware into MiiNePort device from MiiNePort E1 standard firmware V1.7.

For E2, user can upgrade MiiNePort SDK firmware into MiiNePort device from MiiNePort E2 standard firmware V1.3.

After upgrading successfully, the setting of MiiNePort will be reset to default.

6. NetEZ Technologies

This chapter introduces the NetEZ technology family and its innovative functions.

SCM (Serial Command Mode)



The MiiNePort E1/E2-SDK's SCM (Serial Command Mode) allows the module's parameters to be retrieved or configured through the serial port, rather than over the network. This is done using specially parsed commands sent to the module through the serial port.

SCM is often used when your device has already been used in actual applications and you need to change the MiiNePort E1/E2-SDK's configuration, such as changing the device's IP address by using your device's keypad. The details are shown below:

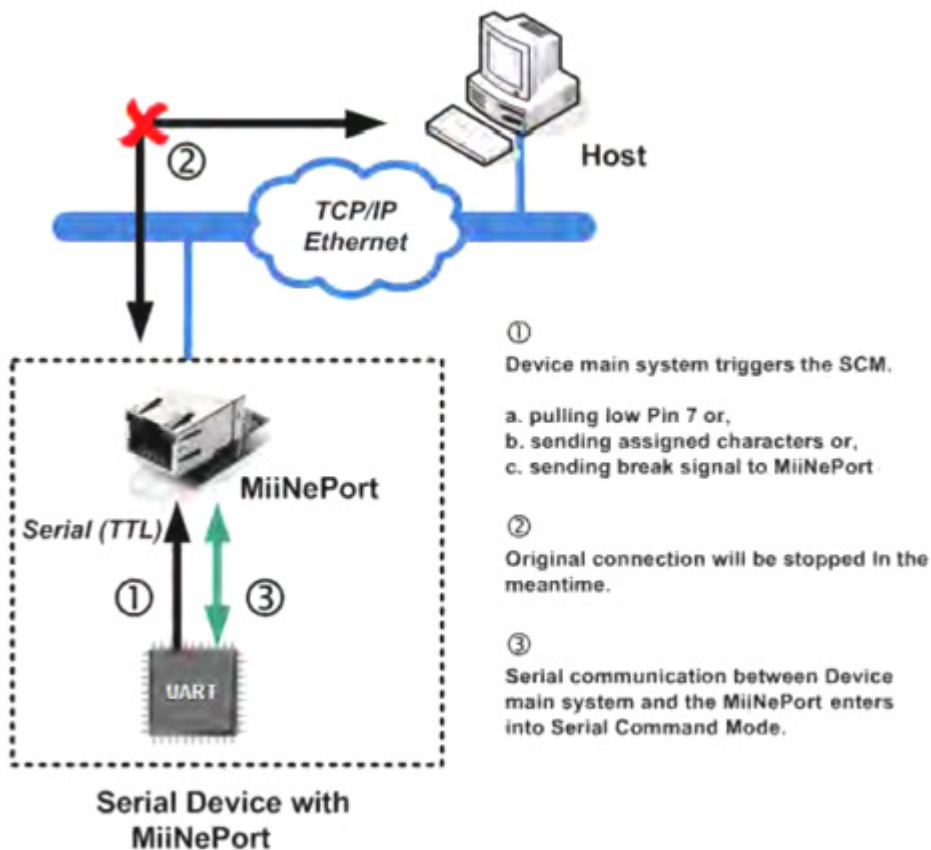

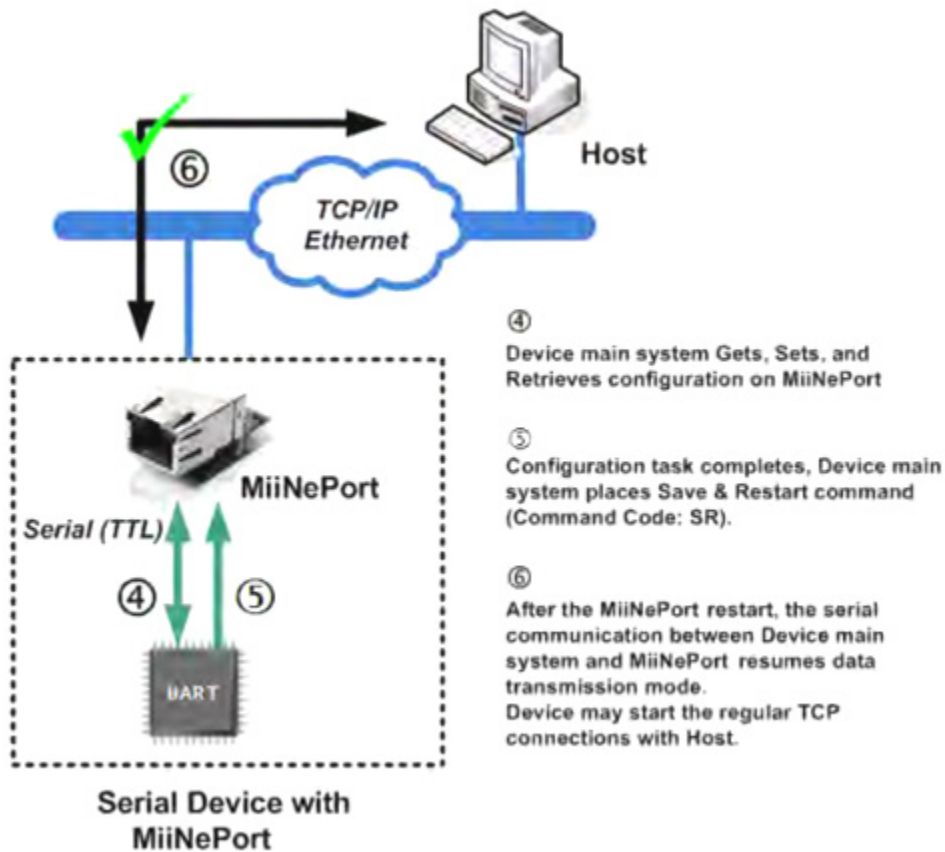

NOTE

Set the interval to 50 ms or higher under SCM mode.

Refer to Appendix A: **Introduction to SCM (Serial Command Mode) Command Set** for detailed instructions on using SCM commands.

EXTrigger (External Trigger)

This function is for MiiNePort E1-SDK only.

The MiiNePort E1-SDK's EXTrigger has two functions: (1) Resetting the module to Moxa's default configuration, and (2) Restarting the module. EXTrigger provides you with an easy network troubleshooting tool that can be used without stopping the device's normal operation.

The Reset-to-Default function is enabled by default and cannot be disabled. This design prevents device deadlock in the future if you or your customer forgets the password and cannot access the console to troubleshoot the device. To activate the EXTrigger's Reset to Default function, press the button inside the RJ45 jack for five seconds while your device and the MiiNePort E1-SDK is starting up.

The Restart function simply shuts down the module and then turns it back on. This does not affect any settings in the module but is a commonly used method for initial troubleshooting. Simply hold the button for five seconds during device operation to restart the MiiNePort E1-SDK module.



NOTE

The Restart function of ExTrigger is disabled in Moxa's factory default settings.

Refer to the following table describing the LED interaction with EXTrigger.

EXTrigger	Fault/In Use LED Behavior	Blinking Duration	Trigger Timing	Note
Restart	0.5 time/sec (Blinks amber slowly)	5 sec	Press the button anytime during operation.	When LED is Off (stops blinking) 1. Function active 2. Release button

EXTrigger is an external Digital Input (DI) that can be accessed by you or the device's end user. You can design your own application by leveraging this external DI. Contact Moxa for information about custom EXTrigger functions.

EZPower



NOTE

This function is only available for the MiiNePort E2-SDK.

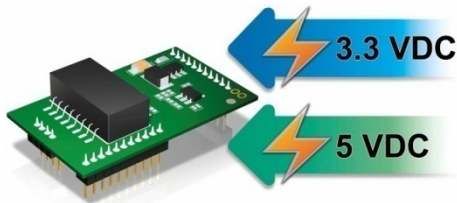

The **EZPower** function makes it easy to configure the MiiNePort's input voltage. Use EZPower to configure the MiiNePort's system power input to either 3.3 VDC or 5 VDC.

7. Android API Instructions

Overview

If you want to remote control your serial devices on an Android platform, then the MxNPortAPI is a simple application programming tool you can use. The MxNPortAPI helps programmers develop an Android application to access the device server by TCP/IP.

The MxNPortAPI provides frequently used serial command sets like port control, input/output, etc., and the style of developed Android application is similar to MOXA Driver Manager. For more details of the provided functions, please refer to the **MxNPortAPI Function Groups** section.

This MxNPortAPI is layered between the Android application and Android network manager framework. This Android library is compatible with Java 1.7, Android 3.1 (Honeycomb - API version 12), and later versions.

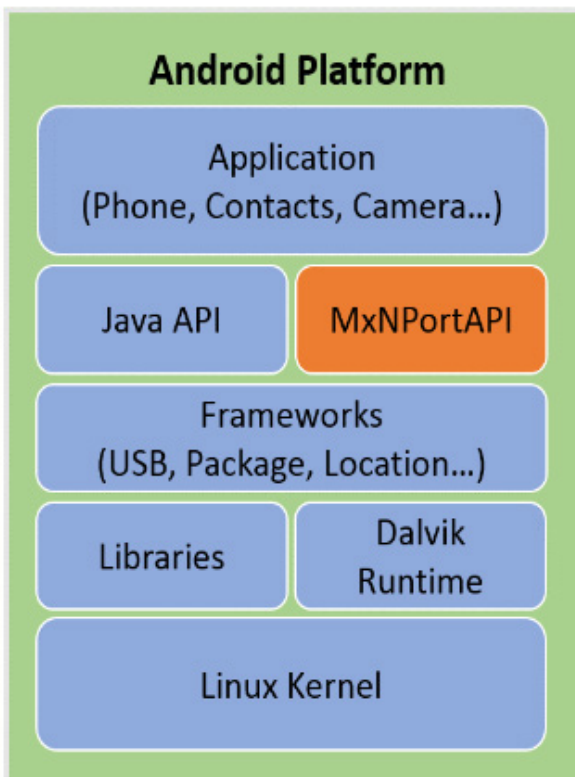

How to Start MxNPortAPI

You can download the MxNPortAPI from MOXA website at <http://www.moxa.com> and develop the application program in popular OSs, such as Windows, Linux, or Mac.

(You can refer the Android studio website to see the system requirements for the development environment: <https://developer.android.com/studio/index.html?hl=zh-tw#Requirements>).

To start your application program, please unzip the MxNPortAPI file and refer to the index (.html) under the Help directory.

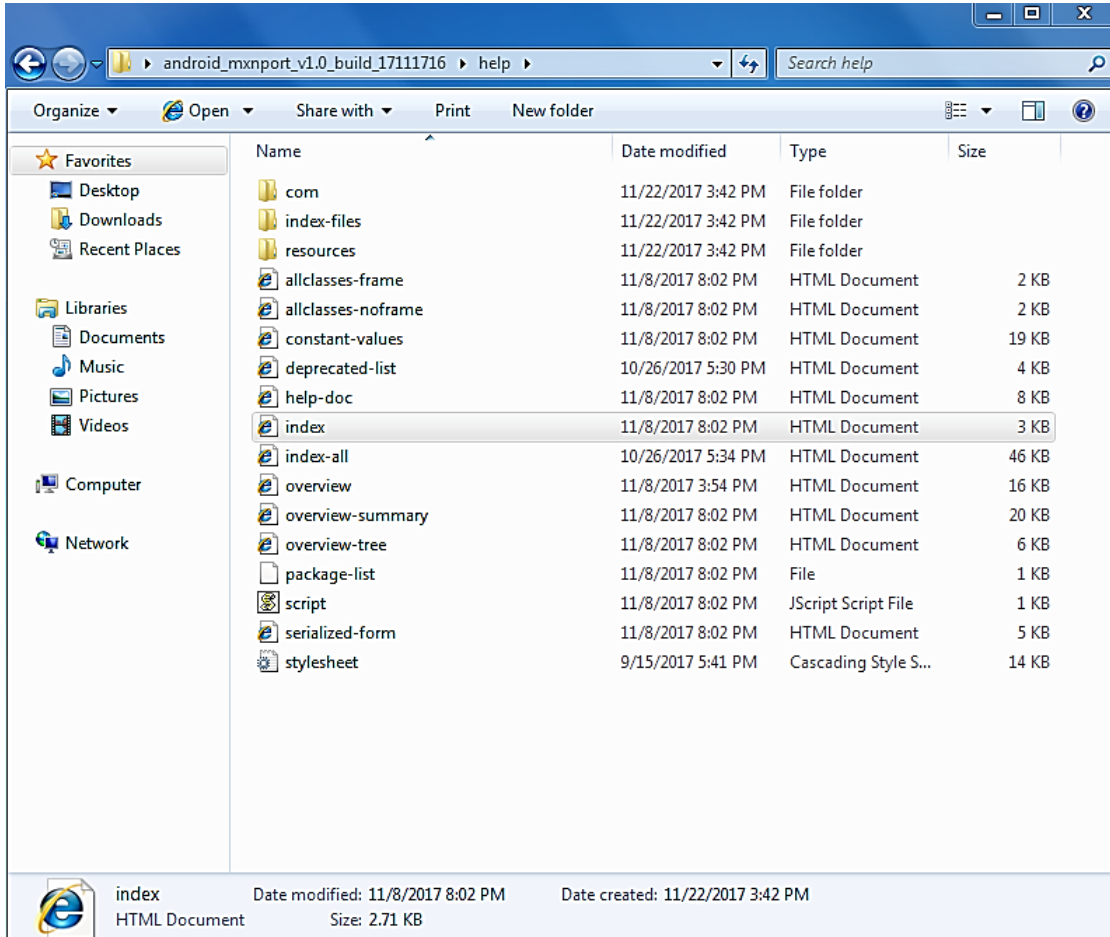

For more details about the installation, please refer to the **Overview** section.

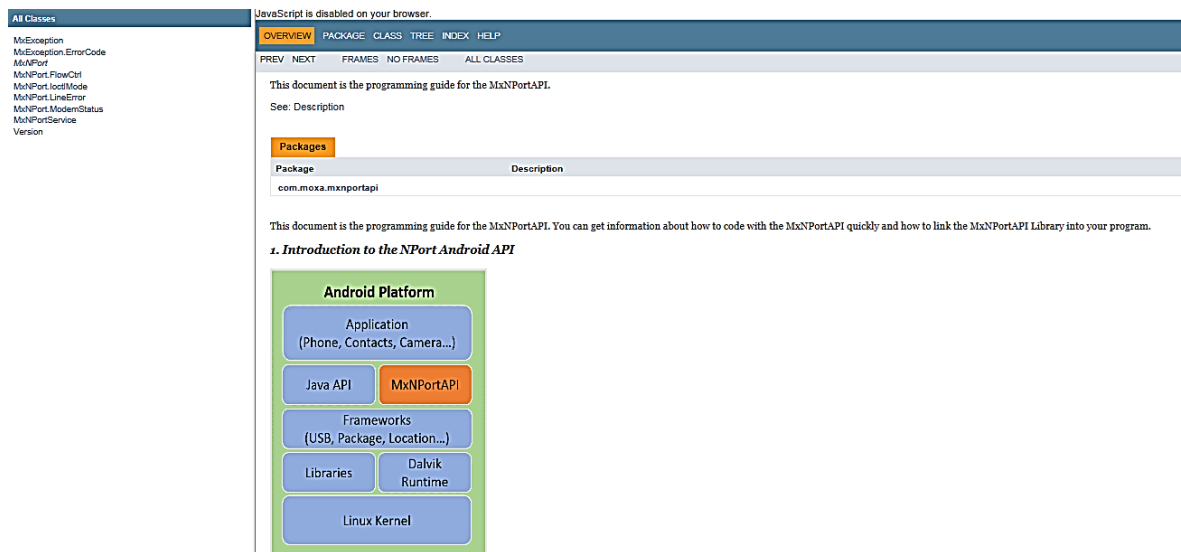

MxNPortAPI Function Groups

The supported functions in this API are listed below:

Port Control	Input/Output	Port Status Inquiry	Miscellaneous
open close setIoctlMode setFlowCtrl setBaud setRTS setDTR flush	read write	getBaud getFlowCtrl getIoctlMode getLineStatus getModemStatus getOQueue	setBreak

Example Program

To make sure this API is workable with a device server on an Android platform, see the example program below:

```
Thread thread = new Thread()
{
    @Override
    public void run() {
        /* Enumerate and initialize NPorts on system */
        List<MxNPort> NPortList = MxNPortService.getNPortInfoList();
        if(NPortList!=null){
            MxNPort.IoctlMode mode = new MxNPort.IoctlMode();
            mode.baudRate = 38400;
            mode.dataBits = MxNPort.DATA_BITS_8;
            mode.parity = MxNPort.PARITY_NONE;
            mode.stopBits = MxNPort.STOP_BITS_1;

            MxNPort mxNPort = NPortList.get(0); /* Get first NPort device */
            try {
                byte[] buf = {'H','e','l','l','o',' ',' ','W','o','r','l','d'};
                mxNPort.open(); /*open port*/
                mxNPort.setIoctlMode(mode); /*serial parameters setting*/
                mxNPort.write(buf, buf.length); /*write data*/
                mxNPort.close(); /*close port*/
            } catch (MxException e){
                /*Error handling*/
            }
        }
    }
};
thread.start();
```

A. Introduction to SCM (Serial Command Mode) Command Set

Command/Reply Format

Single Line Command Format

Head 1 byte	Op 1 byte	Cmd. 2 bytes	Parameters 0 to n bytes	Tail 1 to 2 bytes
----------------	--------------	-----------------	----------------------------	----------------------

Single Line Reply Format

Head 1 byte	Op 1 byte	Cmd. 2 bytes	ST 1 byte	Parameters 0 to n bytes	Tail 1 to 2 bytes
----------------	--------------	-----------------	--------------	----------------------------	----------------------

Head and Tail Format

	Head 1 byte	-	Tail 1 or 2 bytes
Command	?	-	CR LF CR-LF
Reply	!	-	LF

Operation Codes

Operation Code	Meaning
G	Get configuration from MiiNePort's RAM
S	Set configuration to MiiNePort's RAM
R	Retrieve running configuration
V	View status
C	Control

Status Codes

Status Code	Meaning
E	Enter Serial Command Mode
0	Command was executed successfully
1	Unrecognized format
2	Operation is not valid
3	Command is not valid
4	Parameter is incorrect
5	Parameter is too long

Restriction

The total number of parameters in a single command cannot exceed 1024 characters.

Command Code

Command Code for Getting the Configuration

Device Name

Command code: BN
Command parameters: N/A
Reply parameters: MiiNePort's name.

?GBN↵	System requests configured device name for this MiiNePort.
!GBN0MiiNePort_E1_9527↵	MiiNePort reports device name as MiiNePort_E1_9527

IP configuration

Command code: NC
Command parameters: N/A
Reply parameters: MiiNePort's IP configuration index as follows.

0	Static
1	DHCP
2	DHCP/BOOTP
3	BOOTP
4	AUTOIP

?GNC↵	System requests IP configuration for this MiiNePort.
!GNC00↵	MiiNePort reports IP configuration as 'Static'.

IP address

Command code: NI
Command parameters: N/A
Reply parameters: MiiNePort's IP address.

?GNI↵	System requests IP address for this MiiNePort.
!GNI0192.168.127.254↵	MiiNePort reports IP address as '192.168.127.254'.

Netmask

Command code: NM
Command parameters: N/A
Reply parameters: MiiNePort's Netmask address.

?GNM↵	System requests Netmask address for this MiiNePort.
!GNM0255.255.255.0↵	MiiNePort reports netmask as '255.255.255.0'.

Gateway

Command code: NG
Command parameters: N/A
Reply parameters: MiiNePort's Gateway address.

?GNG↵	System requests Gateway address for this MiiNePort.
!GNG0255.255.255.255↵	MiiNePort reports Gateway address as '255.255.255.255'.

DNS

Command code: ND

Command parameters: The index (1 or 2) of DNS server.

Reply parameters: MiiNePort's DNS address.

?GND1↵	System requests DNS server 1 address for this MiiNePort.
!GND0192.168.1.2↵	MiiNePort reports DNS server 1 address as '192.168.1.2'.

IP configuration

Command code: NC

Command parameters: MiiNePort's IP configuration index as shown in the following table

Reply parameters: N/A

0	Static
1	DHCP
2	DHCP/BOOTP
3	BOOTP
4	AutoIP

?SNC0↵	System sets IP configuration as 'Static'.
!SNC0↵	MiiNePort reports command executed successfully.

IP address

Command code: NI

Command parameters: MiiNePort's IP address.

Reply parameters: N/A

?SNI192.168.1.2↵	System sets IP address as '192.168.1.2'.
!SNI0↵	MiiNePort reports command executed successfully.

Netmask

Command code: NM

Command parameters: MiiNePort's Netmask address.

Reply parameters: N/A

?SNM255.255.255.0↵	System sets Netmask as '255.255.255.0'.
!SNM0↵	MiiNePort reports command executed successfully.

Gateway

Command code: NG

Command parameters: MiiNePort's Gateway address.

Reply parameters: N/A

?SNG192.168.1.254↵	System sets Gateway as '192.168.1.254'.
!SNG0↵	MiiNePort reports command executed successfully.

DNS

Command code: ND

Command parameters: The index (1,2) and DNS server address, separated by a semicolon (;).

Reply parameters: N/A

?SND1;192.168.1.123↵	System sets DNS1 as '192.168.1.123'.
!SND0↵	MiiNePort reports command executed successfully.

Command Codes for Retrieving Running Configuration

Device Name

Command code: BN
Command parameters: N/A
Reply parameters: MiiNePort's name.

?RBN↵	System requests configured device name for this MiiNePort.
!RBN0MiiNePort_9527↵	MiiNePort reports device name as 'MiiNePort_9527'.

IP configuration

Command code: NC
Command parameters: N/A
Reply parameters: MiiNePort's IP configuration index as follows.

0	Static
1	DHCP
2	DHCP/BOOTP
3	BOOTP
4	AutoIP

?RNC↵	System requests IP configuration for this MiiNePort.
!RNC00↵	MiiNePort reports IP configuration as 'Static'.

IP address

Command code: NI
Command parameters: N/A
Reply parameters: MiiNePort's IP address.

?RNI↵	System requests IP address for this MiiNePort.
!RNI0192.168.127.254↵	MiiNePort reports IP address as '192.168.127.254'.

Netmask

Command code: NM
Command parameters: N/A
Reply parameters: MiiNePort's Netmask address.

?RNM↵	System requests Netmask address for this MiiNePort.
!RNM0255.255.255.0↵	MiiNePort reports netmask as '255.255.255.0'.

Gateway

Command code: NG
Command parameters: N/A
Reply parameters: MiiNePort's Gateway address.

?RNG↵	System requests Gateway address for this MiiNePort.
!RNM0255.255.255.255↵	MiiNePort reports Gateway address as '255.255.255.255'.

Serial Number

Command code: @S
Command parameters: N/A
Reply parameters: MiiNePort's serial number, in digit notation.

?R@S↵	System requests MiiNePort's serial number.
!R@S09527↵	MiiNePort reports serial number is 9527.

Firmware Version

Command code: @V

Command parameters: N/A

Reply parameters: MiiNePort's firmware version. A single dot separates version parts, with at least two parts (major.minor) and at most three parts (major.minor.rev).

?R@V↵	System requests MiiNePort's firmware version.
!R@V01.0↵	MiiNePort reports firmware version is 1.0.

Firmware Build Number

Command code: @B

Command parameters: N/A

Reply parameters: MiiNePort's firmware build number, eight digits.

?R@B↵	System requests MiiNePort's firmware build number.
!R@B009021208↵	MiiNePort reports build number is 09021208.

MAC address

Command code: @M

Command parameters: N/A

Reply parameters: MiiNePort's MAC address.

?R@M↵	System requests MiiNePort's firmware build number.
!R@M00:90:E8:71:00:10↵	MiiNePort reports MAC address is 00:90:E8:71:00:10.

Command Codes for Viewing the Status

Control Command Codes

PING

Command code: NP

Command parameters: Target host name or IP address.

Reply parameters: A single minus symbol shows the target host did not reply in 1000 milliseconds.

Otherwise, one decimal number showing the reply latency in milliseconds is returned.

?CNPwww.moxa.com↵	System requests to PING www.moxa.com.
!CNP010↵	Target host replies in 10 milliseconds.
?CNP192.168.1.1↵	System requests to PING 192.168.1.1.
!CNP0-↵	Target host did not reply in 1000 milliseconds.

Load Factory Default

Command code: LD

Note that this command is not applied to the configuration until you save and restart the MiiNePort.

Command parameters: '1' for "All setting", '0' for "Keep IP setting".

Reply parameters: N/A

?CLD0↵	System requests to load factory default.
!CLD0↵	System loads factory default successfully.

B. Well-Known Port Numbers

This appendix is included for your reference. Listed below are port numbers that already have a well-established use. These port numbers should be avoided when assigning a port number to your MiiNePort E1 Series module; otherwise, you may experience network problems. Refer to the RFC 1700 standard for Well-Known Port Numbers or refer to the following introduction from IANA.

- The port numbers are divided into three ranges: the Well-Known Ports, the Registered Ports, and the Dynamic and/or Private Ports.
- The Well-Known Ports are those from 0 through 1023.
- The Registered Ports are those from 1024 through 49151.
- The Dynamic and/or Private Ports are those from 49152 through 65535.

The Well-Known Ports are assigned by IANA, and on most systems, can only be used by system processes or by programs executed by privileged users. The following table shows famous port numbers among the well-known port numbers. For more details, visit the IANA website at <http://www.iana.org/assignments/port-numbers>.

TCP Socket	Application Service
0	Reserved
1	TCP Port Service Multiplexor
2	Management Utility
7	Echo
9	Discard
11	Active Users (sysstat)
13	Daytime
15	Netstat
20	FTP data port
21	FTP CONTROL port
23	Telnet
25	SMTP (Simple Mail Transfer Protocol)
37	Time (Time Server)
42	Host name server (names server)
43	Whois (nickname)
49	(Login Host Protocol) (Login)
53	Domain Name Server (domain)
79	Finger protocol (Finger)
80	World Wide Web HTTP
119	Network News Transfer Protocol (NNTP)
123	Network Time Protocol
213	IPX
160 - 223	Reserved for future use

UDP Socket	Application Service
0	Reserved
2	Management Utility
7	Echo
9	Discard
11	Active Users (systat)
13	Daytime
35	Any private printer server
39	Resource Location Protocol
42	Host name server (names server)
43	Whois (nickname)
49	(Login Host Protocol) (Login)
53	Domain Name Server (domain)
69	Trivial Transfer Protocol (TFTP)
70	Gopher Protocol
79	Finger Protocol
80	World Wide Web HTTP
107	Remote Telnet Service
111	Sun Remote Procedure Call (Sunrpc)
119	Network news Transfer Protocol (NNTP)
123	Network Time protocol (ntp)
161	SNMP (Simple Network Management Protocol)
162	SNMP Traps
213	IPX (Used for IP Tunneling)

C. SNMP Agent with MIB II and RS-232 Like Groups

MiiNePort E1 Series modules have SNMP (Simple Network Management Protocol) agent software built in. The software supports RFC1317 RS-232 like groups and RFC 1213 MIB-II. The following table lists the standard MIB-II groups, as well as the variable implementations for the MiiNePort E1 Series modules.

RFC1 213 MIB-II supported SNMP variables:

System MIB	Interfaces MIB	IP MIB	ICMP MIB
SysDescr	ifNumber	ipForwarding	IcmpInMsgs
SysObjectID	ifIndex	ipDefaultTTL	IcmpInErrors
SysUpTime	ifDescr	ipInreceives	IcmpInDestUnreachs
SysContact	ifType	ipInHdrErrors	IcmpInTimeExcds
SysName	ifMtu	ipInAddrErrors	IcmpInParmProbs
SysLocation	ifSpeed	ipForwDatagrams	IcmpInSrcQuenchs
SysServices	ifPhysAddress	ipInUnknownProtos	IcmpInRedirects
	ifAdminStatus	ipInDiscards	IcmpInEchos
	ifOperStatus	ipInDelivers	IcmpInEchoReps
	ifLastChange	ipOutRequests	IcmpInTimestamps
	ifInOctets	ipOutDiscards	IcmpTimestampReps
	ifInUcastPkts	ipOutNoRoutes	IcmpInAddrMasks
	ifInNUcastPkts	ipReasmTimeout	IcmpOutMsgs
	ifInDiscards	ipReasmReqds	IcmpOutErrors
	ifInErrors	ipReasmOKs	IcmpOutDestUnreachs
	ifInUnknownProtos	ipReasmFails	IcmpOutTimeExcds
	ifOutOctets	ipFragOKs	IcmpOutParmProbs
	ifOutUcastPkts	ipFragFails	IcmpOutSrcQuenchs
	ifOutNUcastPkts	ipFragCreates	IcmpOutRedirects
	ifOutDiscards	ipAdEntAddr	IcmpOutEchos
	ifOutErrors	ipAdEntIfIndex	IcmpOutEchoReps
	ifOutQLen	ipAdEntNetMask	IcmpOutTimestamps
	ifSpecific	ipAdEntBcastAddr	IcmpOutTimestampReps
		ipAdEntReasmMaxSize	IcmpOutAddrMasks
		IpNetToMediaIfIndex	IcmpOutAddrMaskReps
		IpNetToMediaPhysAddress	
		IpNetToMediaNetAddress	
		IpNetToMediaType	
		IpRoutingDiscards	

UDP MIB	TCP MIB	SNMP MIB	Address Translation MIB
UdpInDatagrams	tcpRtoAlgorithm	snmpInPkts	AtIfIndex
UdpNoPorts	tcpRtoMin	snmpOutPkts	AtPhysAddress
UdpInErrors	tcpRtoMax	snmpInBadVersions	AtNetAddress
UdpOutDatagrams	tcpMaxConn	snmpInBadCommunityNames	
UdpLocalAddress	tcpActiveOpens	snmpInASNParseErrs	
UdpLocalPort	tcpPassiveOpens	snmpInTooBig	
	tcpAttempFails	snmpInNoSuchNames	
	tcpEstabResets	snmpInBadValues	
	tcpCurrEstab	snmpInReadOnly	
	tcpInSegs	snmpInGenErrs	
	tcpOutSegs	snmpInTotalReqVars	

D. Supported File Systems

There are two file systems in MiiNePort-SDK for you to access via file operation APIs: ROM file system and FAT

ROM File System

When you create your project under MiiNePort-IDE, you can find a directory named <romfs> under your project directory, as shown in the following:

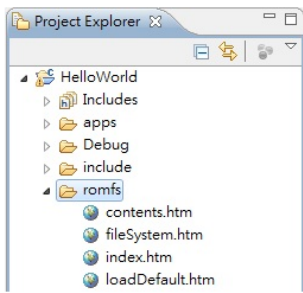
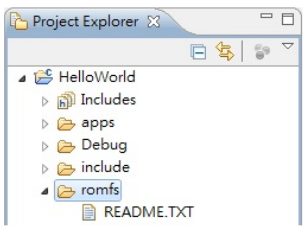
<i>When Web Console is enabled, <romfs> contains web page files by default.</i>	<i>When Web Console is disabled, <romfs> contains only README.TXT by default.</i>
	
File open example: <pre>open("/sys/index.htm", O_RDONLY);</pre>	File open example: <pre>open("/sys/README.TXT", O_RDONLY);</pre>

All files in <romfs> directory will be compiled into ROM file system of MiiNePort-SDK. The files in ROM file system are available through the mount point "/sys". The maximum storage size of ROM file system is 512K bytes.

All files in ROM file system are read only. In your application, if you need to read contents from some files but do not need to write data to these files, you can put these read-only files in <romfs> directory under your project and open these files under "/sys" directory with O_RDONLY flag in your program.



NOTE

In your program, the files under "/sys" directory are read only, and you cannot create/delete files under this directory.

FAT File System

There is a FAT file system with maximum storage size of 512K bytes in MiiNePort-SDK for you to create/read/write/delete files. In your program, you can access FAT file system under "/usr" directory. This FAT file system only supports 8.3 filename format. A 8.3 filename has at maximum eight characters, optionally followed by a period "." and a filename extension of maximum three characters. The long filename is not supported.

Example: File write/read

The following example uses POSIX library to write/read a file.

Example:

```
#include <stdio.h>
#include <string.h>
#include <sdksys.h>
#include <sdkfile.h>

AP_VER(1, 0, 0);

int main(void)
{
    int fd;
    ssize_t len;
    char buf[36];

    /*
     * Open file for write.
     */
    fd = open("/usr/test.txt", O_CREAT | O_TRUNC | O_WRONLY);
    /*
     * Write data to file.
     */
    sprintf(buf, "Hello POSIX!");
    write(fd, buf, strlen(buf) + 1);
    /*
     * Synchronise changes to a file.
     */
    fsync(fd);
    /*
     * Close file.
     */
    close(fd);

    /*
     * Open file for read.
     */
    fd = open("/usr/test.txt", O_RDONLY);
    /*
     * Read data from file.
     */
    memset(buf, 0, sizeof(buf));
    len = read(fd, buf, sizeof(buf));
    printf("Read %ld bytes: %s\n", len, buf);
    /*
     * Close file.
     */
    close(fd);

    return 0;
}
```