

# OnCell 3120-LTE-1 User's Manual

---

Version 1.3, March 2022

[www.moxa.com/product](http://www.moxa.com/product)



© 2022 Moxa Inc. All rights reserved.

# OnCell 3120-LTE-1 User's Manual

The software described in this manual is furnished under a license agreement and may be used only in accordance with the terms of that agreement.

## Copyright Notice

© 2022 Moxa Inc. All rights reserved.

## Trademarks

The MOXA logo is a registered trademark of Moxa Inc.  
All other trademarks or registered marks in this manual belong to their respective manufacturers.

## Disclaimer

Information in this document is subject to change without notice and does not represent a commitment on the part of Moxa.

Moxa provides this document as is, without warranty of any kind, either expressed or implied, including, but not limited to, its particular purpose. Moxa reserves the right to make improvements and/or changes to this manual, or to the products and/or the programs described in this manual, at any time.

Information provided in this manual is intended to be accurate and reliable. However, Moxa assumes no responsibility for its use, or for any infringements on the rights of third parties that may result from its use.

This product might include unintentional technical or typographical errors. Changes are periodically made to the information herein to correct such errors, and these changes are incorporated into new editions of the publication.

## Technical Support Contact Information

[www.moxa.com/support](http://www.moxa.com/support)

### **Moxa Americas**

Toll-free: 1-888-669-2872  
Tel: +1-714-528-6777  
Fax: +1-714-528-6778

### **Moxa Europe**

Tel: +49-89-3 70 03 99-0  
Fax: +49-89-3 70 03 99-99

### **Moxa India**

Tel: +91-80-4172-9088  
Fax: +91-80-4132-1045

### **Moxa China (Shanghai office)**

Toll-free: 800-820-5036  
Tel: +86-21-5258-9955  
Fax: +86-21-5258-5505

### **Moxa Asia-Pacific**

Tel: +886-2-8919-1230  
Fax: +886-2-8919-1231

# Table of Contents

<b>1. Introduction</b>	<b>1-1</b>
Overview	1-2
Package Checklist	1-2
Product Features	1-2
Product Specifications	1-2
Functional Design	1-3
LED Indicators	1-4
Beeper	1-4
Reset Button	1-5
<b>2. Getting Started</b>	<b>2-1</b>
First-time Installation and Configuration	2-2
Step 1: Install a SIM Card	2-2
Step 2: Turn On the OnCell 3120-LTE-1	2-2
Step 3: Connect the OnCell 3120-LTE-1 to a Computer	2-2
Step 4: Configure an IP Address for the Computer	2-2
Step 5: Access the Web Console	2-3
Step 6: Establish a Cellular Connection	2-4
Step 7: Verify the Cellular Connection	2-4
<b>3. Web Console Configuration</b>	<b>3-1</b>
Accessing the Web Console	3-2
Configuration Menu Overview	3-4
Overview	3-8
General Setup	3-8
System Information	3-8
Interface On/Off	3-9
Network Settings	3-9
System Time	3-11
Cellular Settings	3-12
Cellular Operation Mode	3-12
Cellular WAN Settings	3-13
GuaranLink Settings	3-15
Auto IP Report Settings	3-19
OnCell Central Manager Settings	3-20
Advanced Settings	3-20
DHCP Server	3-20
DDNS	3-22
Packet Filters	3-22
Port Forwarding Function	3-24
SNMP Agent	3-25
VPN	3-27
Scheduling and Power Management	3-44
Serial Port Settings	3-45
Serial Operation Mode	3-45
Communication Parameters	3-71
Data Buffering/Log	3-73
Cipher Settings	3-73
Logs and Notification	3-74
System Log	3-74
Syslog	3-75
Email Notifications	3-76
Trap	3-77
SMS	3-78
Status	3-79
Serial	3-79
VPN	3-81
DNS Status	3-83
SIM Status	3-83
DHCP Client List	3-83
System Log	3-84
LAN Status	3-84
System Status	3-84
Network Status	3-85
Maintenance	3-88
Console Settings	3-88
Ping Command	3-89
Firmware Upgrade	3-89
Configuration Import & Export	3-90
Load Factory Default	3-91

Account Settings .....	3-92
Change Password .....	3-93
Locate Device .....	3-94
Miscellaneous Settings .....	3-94
Troubleshooting .....	3-94
Manual SMS.....	3-95
Remote SMS Control.....	3-95
Saving the Configuration .....	3-96
Restart .....	3-97
Logout.....	3-98
<b>4. Software Installation and Configuration .....</b>	<b>4-1</b>
Overview .....	4-2
Wireless Search Utility.....	4-2
Installing the Wireless Search Utility .....	4-2
Configuring the Wireless Search Utility.....	4-5
<b>A. Supporting Information .....</b>	<b>A-1</b>
Firmware Recovery .....	A-2
DoC (Declaration of Conformity) .....	A-3
Federal Communication Commission Interference Statement .....	A-3
R&TTE Compliance Statement.....	A-4
<b>B. Dynamic Domain Name Server .....</b>	<b>B-1</b>
<b>C. Well-known Port Numbers .....</b>	<b>C-1</b>
<b>D. AT Commands for Modem Mode .....</b>	<b>D-1</b>
Setting Up Modem Mode .....	D-2
List of Supported AT Commands .....	D-4
Alphabetical List of Commands.....	D-4
Short Message Service (SMS) Commands.....	D-6
Call-related Commands.....	D-10
Network Service Commands .....	D-12
Configuration Commands .....	D-13
Identification Commands Miscellaneous Commands .....	D-15
Miscellaneous Commands.....	D-16
Packet Domain Related Commands.....	D-16
Security Commands.....	D-17
Serial Interface Control Commands .....	D-17
Status Control Commands .....	D-18



## Introduction

---

The OnCell 3120-LTE-1 industrial cellular gateway is an ideal wireless solution for remote monitoring applications. The wide-temperature support makes the OnCell 3120-LTE-1 rugged enough for any harsh industrial environment.

The following topics are covered in this chapter:

- **Overview**
- **Package Checklist**
- **Product Features**
- **Product Specifications**
- **Functional Design**
  - LED Indicators
  - Beeper
  - Reset Button

## Overview

The OnCell 3120-LTE-1 is a reliable, secure, LTE gateway with state-of-the-art global LTE coverage. This 4G cellular gateway provides a reliable connection to your Ethernet network for cellular applications.

To enhance industrial reliability, high-level EMS and wide-temperature support give the OnCell 3120-LTE-1 the highest level of device stability for any rugged environment. In addition to dual-SIM GuaranLink, the OnCell 3120-LTE-1 supports network redundancy to ensure uninterrupted connectivity.

The OnCell 3120-LTE-1 also comes with a 3-in-1 serial port for serial communication over LTE cellular networks to enable data exchange with serial/Ethernet devices.

## Package Checklist

Before you install the OnCell 3120-LTE-1, make sure that the package contains the following items:

- OnCell 3120-LTE-1
- DIN-rail kit
- Quick installation guide (printed)
- Warranty card

If any of these items is missing or damaged, please contact your customer service representative for assistance.

**NOTE** The above items come with the standard OnCell 3120-LTE-1 model, but the package contents may vary for customized versions.

## Product Features

- Supports multiple LTE bands
- Universal cellular bands support for GSM/GPRS/HSPA
- Dual cellular operator backup with dual-SIM GuaranLink for reliable cellular connectivity
- VPN secure connection capability with IPsec, GRE, and OpenVPN protocols
- Industrial-grade design:
  - Power save mode to reduce power consumption
  - -30 to 70°C wide operating temperature (wide temperature support only applies to certain SKUs)
  - Rugged hardware design well-suited for hazardous locations (ATEX Zone 2/IECEX)

## Product Specifications

**NOTE** The latest specifications for Moxa's products can be found at <https://www.moxa.com>.

# Functional Design

Top Panel View

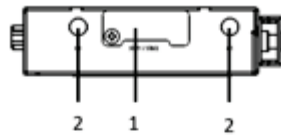

Front Panel View

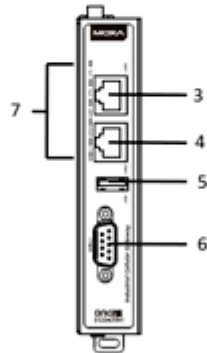

Bottom Panel View

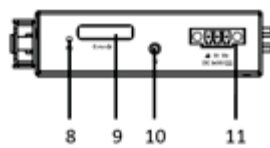

Side Panel View

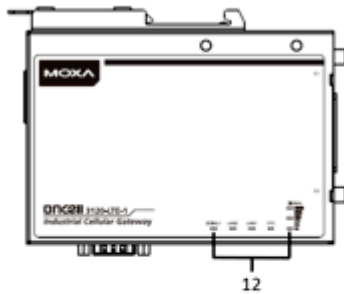

Back Panel View

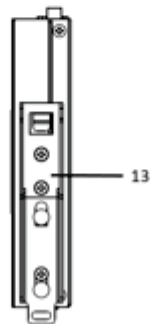

1. SIM card holders (SIM 1/SIM 2)
2. 2x2 MIMO cellular antenna port
3. 10/100 Base T(X) Ethernet port 1 (RJ45)
4. 10/100 Base T(X) Ethernet port 2 (RJ45)
5. USB port
6. DB9 serial port
7. LED display
8. Reset button
9. Console port (reserved for engineering use)
10. Grounding screw (M3)
11. Terminal block (V+, V-, GND)
12. LED display
13. DIN-rail mounting kit

## LED Indicators

The LEDs on the front panel of the OnCell 3120-LTE-1 provide a quick and easy means of determining the current operational status and wireless settings.

The following table summarizes how to read the device’s wireless settings from the LED displays. Additional information is available in the *Chapter 3, Basic Settings* section.

Type	Color	State	Meaning																
SYS (2 LEDs)	Green		Power on: System startup is complete and the system is in operation.																
	Off		No power is supplied to the OnCell device.																
	Green	1. Blinking at 1-sec intervals 2. Blinking at 2-sec intervals 3. Blinking at 0.5-sec intervals 4. Blinking at 5-sec intervals	1. The OnCell device has been located by the Wireless Search Utility. 2. The ABC-02-USB device connected to OnCell device has been detected. 3. Importing or exporting files from/to the ABC-02-USB device. 4. The OnCell device is in power saving mode.																
	Red	1. Steady On 2. Blinking at 1-sec intervals	1. System error or failure to get an IP address for the device. 2. Load/save to the ABC-02-USB device failed.																
LAN 1/2 (4 LEDs)	Green		10/100 Mbps Ethernet mode.																
	Off		Port is not active.																
Serial (2 LEDs)	Green		Transmitting or receiving data.																
	Off		Port is not active.																
LTE (1 LED)	Green		LTE is connected.																
	Green	Blinking at 0.5-sec intervals	UMTS/HSPA/GSM/GPRS/EDGE is connected.																
	Off		No cellular connection.																
Signal (3 LEDs)	Green		<table border="1"> <thead> <tr> <th>Signal Strength*</th> <th>Cellular RSSI</th> <th>RSSI Range (dBm)</th> <th>Comment</th> </tr> </thead> <tbody> <tr> <td>1-2</td> <td>0 &lt; SNR ≤ 12</td> <td>113 &lt; RSSI ≤ -89</td> <td>Marginal-Ok</td> </tr> <tr> <td>3-4</td> <td>12 &lt; SNR ≤ 21</td> <td>-89 &lt; RSSI ≤ -73</td> <td>Ok - Good</td> </tr> <tr> <td>5-6</td> <td>22 &lt; SNR ≤ 31</td> <td>-73 &lt; RSSI ≤ -51</td> <td>Excellent</td> </tr> </tbody> </table>	Signal Strength*	Cellular RSSI	RSSI Range (dBm)	Comment	1-2	0 < SNR ≤ 12	113 < RSSI ≤ -89	Marginal-Ok	3-4	12 < SNR ≤ 21	-89 < RSSI ≤ -73	Ok - Good	5-6	22 < SNR ≤ 31	-73 < RSSI ≤ -51	Excellent
			Signal Strength*	Cellular RSSI	RSSI Range (dBm)	Comment													
			1-2	0 < SNR ≤ 12	113 < RSSI ≤ -89	Marginal-Ok													
			3-4	12 < SNR ≤ 21	-89 < RSSI ≤ -73	Ok - Good													
			5-6	22 < SNR ≤ 31	-73 < RSSI ≤ -51	Excellent													

\* Each signal LED is equivalent to a signal strength of 2 levels.

## Beeper

The beeper emits two short beeps when the system is ready.

## Reset Button

The **RESET** button is located on the bottom panel of the OnCell 3120-LTE-1. You can reboot the OnCell 3120-LTE-1 or reset it to factory default settings by pressing the **RESET** button with a pointed object such as an unfolded paper clip.

- **System reboot:** Hold the RESET button down for under 5 seconds and then release.
- **Reset to factory default:** Hold the RESET button down for *over* 5 seconds until the **SYS** LED turns solid red. Release the button to reset the OnCell 3120-LTE-1.



### ATTENTION

- The OnCell 3120-LTE-1 is NOT a portable mobile device and should be located at least 20 cm away from the human body.
- The OnCell 3120-LTE-1 is NOT designed for the general public. A well-trained technician should be enlisted to ensure safe deployment of OnCell 3120-LTE-1 units, and to establish a wireless network.

## Getting Started

---

This chapter explains how to install Moxa's OnCell 3120-LTE-1 for the first time, and quickly set up your wireless network and test whether the connection is running well. The *Configuration Menu Overview* in Chapter 3 provides a convenient means of determining which functions you need to use.

The following topics are covered in this chapter:

### ▣ **First-time Installation and Configuration**

- Step 1: Install a SIM Card
- Step 2: Turn On the OnCell 3120-LTE-1
- Step 3: Connect the OnCell 3120-LTE-1 to a Computer
- Step 4: Configure an IP Address for the Computer
- Step 5: Access the Web Console
- Step 6: Establish a Cellular Connection
- Step 7: Verify the Cellular Connection

# First—time Installation and Configuration

Before installing the OnCell 3120-LTE-1, make sure that all items in the package checklist are in the box. In addition, you will need access to a notebook computer or PC equipped with an Ethernet port. The OnCell 3120-LTE-1 has a default IP address that you must use when connecting to the device for the first time.

## Step 1: Install a SIM Card

Insert one or two 4G SIM cards into the SIM slots located on the bottom of the OnCell 3120-LTE-1.

The SIM card slots are inside the OnCell 3120-LTE-1's housing. To install a SIM card in one of the slots, do the following:

1. Turn off the OnCell 3120-LTE-1.
2. Remove the screw on the SIM card slot cover.
3. Install a SIM card into the SIM card slot.
  - a. For SIM 1, orient the card such that the gold contacts are facing down and the cut-off edge is to the left.
  - b. For SIM 2, orient the card such that the gold contacts are facing up and the cut-off edge is to the right.
4. Put back the screw on the SIM card slot cover and secure the cover by tightening the screw.

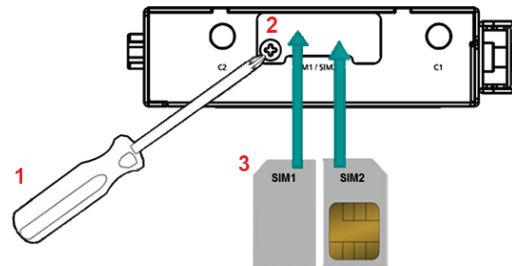

## Step 2: Turn On the OnCell 3120-LTE-1

Turn on the OnCell 3120-LTE-1 by connecting the power terminal block to a DC power source.

## Step 3: Connect the OnCell 3120-LTE-1 to a Computer

Since the OnCell 3120-LTE-1 supports MDI/MDI-X autosensing, you can use either a straight-through cable or crossover cable to connect the OnCell 3120-LTE-1 to a computer. When a connection is established, the LED indicator on the OnCell 3120-LTE-1's LAN port lights up.

## Step 4: Configure an IP Address for the Computer

You must set an IP address for the computer so that it is on the same subnet as the OnCell 3120-LTE-1. Since the OnCell 3120-LTE-1's default IP address is **192.168.127.254** and the subnet mask is **255.255.255.0**, you should set the IP address of the computer to **192.168.127.xxx**.

**NOTE** In the OnCell 3120-LTE-1, you can select **Maintenance > Load Factory Default** and click **Submit** to reset the OnCell 3120-LTE-1 to the factory default settings, which will reset the IP address to **192.168.127.254**.

## Step 5: Access the Web Console

To access the OnCell 3120-LTE-1 web console:

1. Open a web browser and enter `http://192.168.127.254` in the address field.



**NOTE** Default user name and password:

User Name: **admin**  
Password: **moxa**

**Overview (Warn: Change the default password to ensure a higher level of security)**

**This screen displays current active settings**

### System Information

Model name	OnCell 3120-LTE-1-EU
Device name	OnCell 3120-LTE-1_10:29:51

For security reasons, we strongly recommend changing the default password to ensure higher level security. To do so, select **Maintenance > Change Password**, and then follow the on-screen instructions to change the password.

**NOTE** After you click **Apply** to apply the password change, the new password will be effective immediately and the web page will be refreshed. This is indicated by the text, **(Updated)** that appears next to the page header:

**Change Password (Updated)**



## Step 6: Establish a Cellular Connection

After installing the SIM card, obtain the SIM card PIN and APN (Access Point Name) information from your service provider and configure the cellular WAN settings.

To configure the cellular WAN settings and establish a cellular connection:

1. Log in to the web console.
2. Go to **Cellular Settings > Cellular WAN Settings** and enter the SIM card PIN and APN values.
3. Restart the OnCell 3120-LTE-1.

The OnCell 3120-LTE-1 automatically establishes a cellular connection to the service provider after it restarts.

## Step 7: Verify the Cellular Connection

You can use one of the following methods to verify the cellular connection:

1. Check the LED display.

Check the LTE LEDs on the front panel.

If the LTE LEDs are steady, it means that the OnCell is connected to the 4G LTE network. If the LTE LEDs are blinking, it means the OnCell is only connected to the 3G network.

If the LTE LEDs are not lit, it means that a SIM card is not installed or not detected, or the SIM card has not established a 3G/4G data communication link.

Check the LTE signal strength LEDs to see the current signal strength level. If the LTE signal strength LEDs are not lit, this indicates that the OnCell has not established a data service. Make sure that you enter the correct APN information in the web console.

2. Check the **Overview** page in the web console.

Log in to the web console to display the **Overview** page. Check the Cellular RSSI, Cellular WAN IP address, and Cellular Mode fields to identify any connection problems.

For Cellular RSSI (Received Signal Strength Indication), make sure that the value is above 12 in order to maintain a stable connection.

If the Cellular WAN IP address is not available but the Cellular RSSI is more than 12, make sure that the APN configuration is correct. The service provider might assign a private WAN IP address, which is not accessible externally.

3. Test the cellular network access on your computer.

Users with public SIM cards (instead of SIM cards with MDVPN service enabled) can test the connection to the Internet on your computer (assuming that your computer is connected to an Ethernet port on the OnCell 3120-LTE-1).

An example of the configuration settings on the computer is given below:

- Laptop IP Address: 192.168.127.10 (on the same subnet as the OnCell gateway)
- Laptop Subnet Mask: 255.255.255.0 (on the same subnet as the OnCell gateway)
- Laptop Default Gateway: 192.168.127.254 (the OnCell gateway IP address)
- Laptop Primary DNS Server: 8.8.8.8 (test with Google's public DNS server)
- Laptop Primary DNS Server: 8.8.4.4 (test with Google's public DNS server)

After the configuration process is complete, your computer will be able to access the Internet.

For information on testing the connection with a DHCP server, refer to Chapter 3, *Advanced Settings, DHCP Server*.

# Web Console Configuration

---

This chapter describes the web console that you can use to configure your OnCell 3120-LTE-1 and set up a wireless network. The following topics are covered in this chapter:

- ❑ **Accessing the Web Console**
  - Configuration Menu Overview
- ❑ **Overview**
- ❑ **General Setup**
  - System Information
  - Interface On/Off
  - Network Settings
  - System Time
- ❑ **Cellular Settings**
  - Cellular Operation Mode
  - Cellular WAN Settings
  - GuaranLink Settings
  - Auto IP Report Settings
  - OnCell Central Manager Settings
- ❑ **Advanced Settings**
  - DHCP Server
  - DDNS
  - Packet Filters
  - Port Forwarding Function
  - SNMP Agent
  - VPN
  - Scheduling and Power Management
- ❑ **Serial Port Settings**
  - Serial Operation Mode
  - Communication Parameters
  - Data Buffering/Log
  - Cipher Settings
- ❑ **Logs and Notification**
  - System Log
  - Syslog
  - Email Notifications
  - Trap
  - SMS
- ❑ **Status**
  - Serial
  - VPN
  - DNS Status
  - SIM Status
  - DHCP Client List
  - System Log
  - LAN Status
  - System Status
  - Network Status
- ❑ **Maintenance**
  - Console Settings
  - Ping Command
  - Firmware Upgrade
  - Configuration Import & Export
  - Load Factory Default
  - Account Settings
  - Change Password
  - Locate Device
  - Miscellaneous Settings
  - Troubleshooting
  - Manual SMS
  - Remote SMS Control
- ❑ **Saving the Configuration**
- ❑ **Restart**
- ❑ **Logout**

# Accessing the Web Console

Moxa OnCell 3120-LTE-1's web interface provides a convenient way to modify the configuration settings and access the built-in monitoring and network administration functions. The recommended web browser is Microsoft® Internet Explorer 7.0 and above with JVM (Java Virtual Machine) installed.

**NOTE** To use the OnCell 3120-LTE-1's management and monitoring functions from a PC host connected to the same LAN as the OnCell 3120-LTE-1, you must make sure that the PC host and the OnCell 3120-LTE-1 are on the same logical subnet.

The default IP address of an OnCell 3120-LTE-1 is **192.168.127.254**.

To access the OnCell 3120-LTE-1's web-based console management interface, do the following

1. Open your web browser and type the OnCell 3120-LTE-1's IP address in the address field; then, press **Enter**.
2. In the login page, enter the **Username** and **Password** (the default username is "admin" and password is "moxa") and click **Login**.

It may take a few seconds for the web page to load on your computer.



**NOTE** The model name of your OnCell 3120-LTE-1 is shown on the title bar of the web page. You can use this information to identify multiple OnCell 3120-LTE-1 units. The model name is shown as OnCell 3120-LTE-1-XX, where XX is the country code. The country code indicates the OnCell 3120-LTE-1 version and the bandwidth that it uses. The figures shown in this document use an OnCell 3120-LTE-1-EU. The model name that is displayed for your OnCell 3120-LTE-1 may be different from the one shown in this manual.

If an incorrect username or password is entered, a warning message is displayed. The system will lock the user account based on the settings configured in **Maintenance → Account Settings**. The default retry count is 5 times and the default lockout time is 600 seconds. Once an account is locked, the user will have to wait out the duration of the lockout period before retrying.



For additional details, see *Account Settings* under *Maintenance*.

- Use the navigation panel on the left to access the configuration pages.

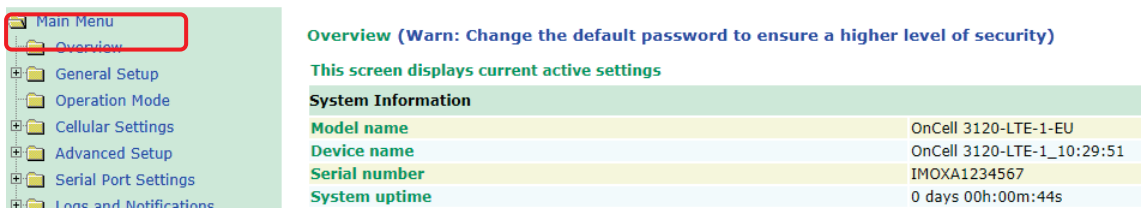

In the following sections we will describe each OnCell 3120-LTE-1 management function in detail, starting with an overview of the links in the navigation panel.

## Configuration Menu Overview

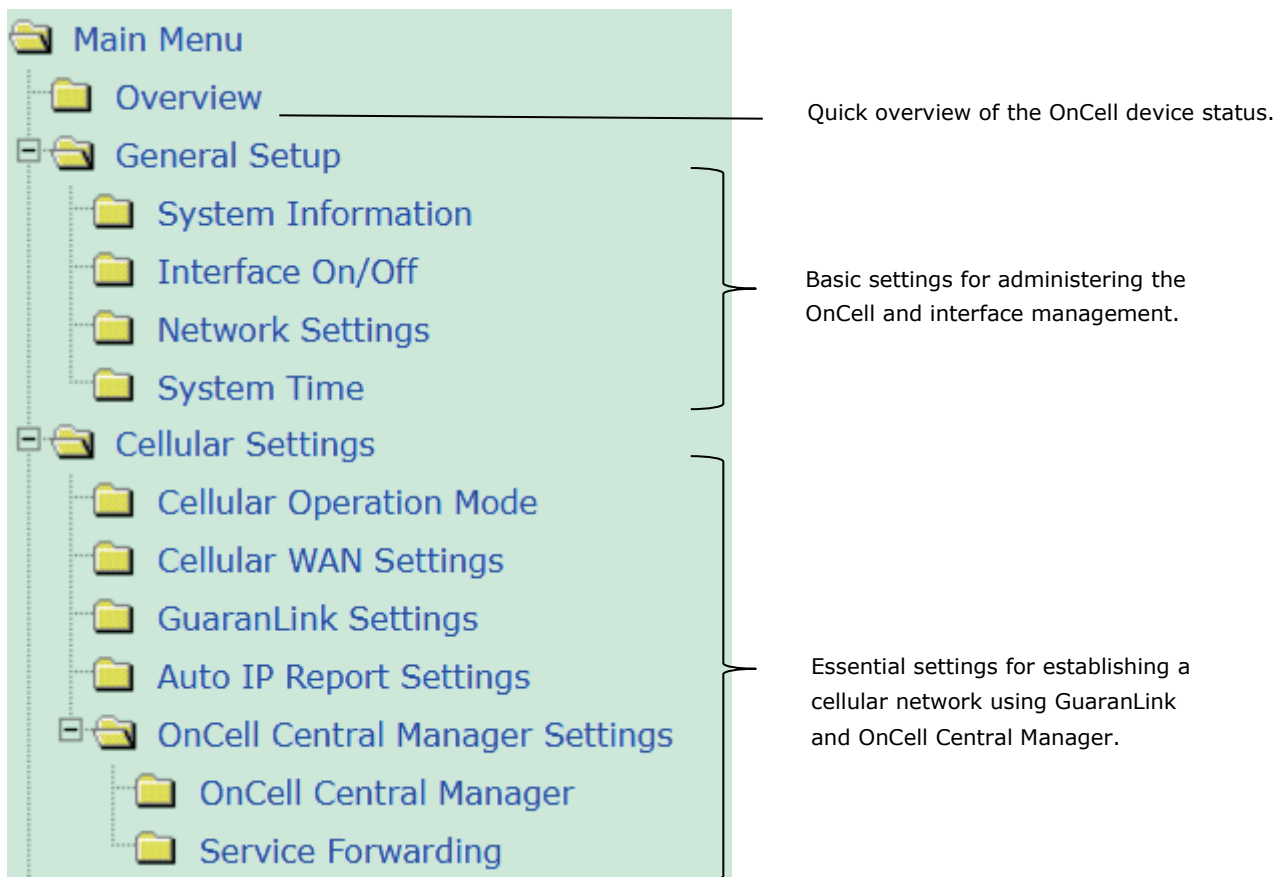

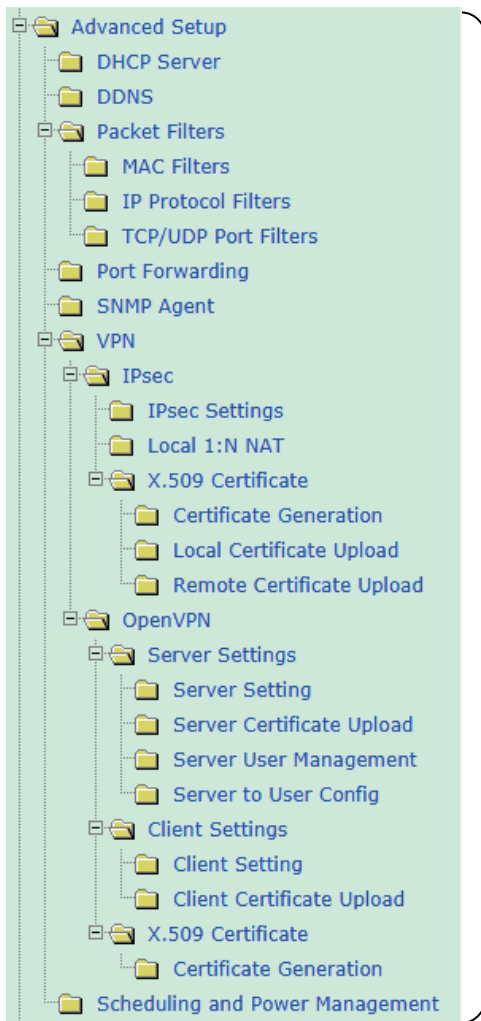

Advanced features to support additional network management functions and secure wired and wireless communication.

Note: These advanced functions are optional.

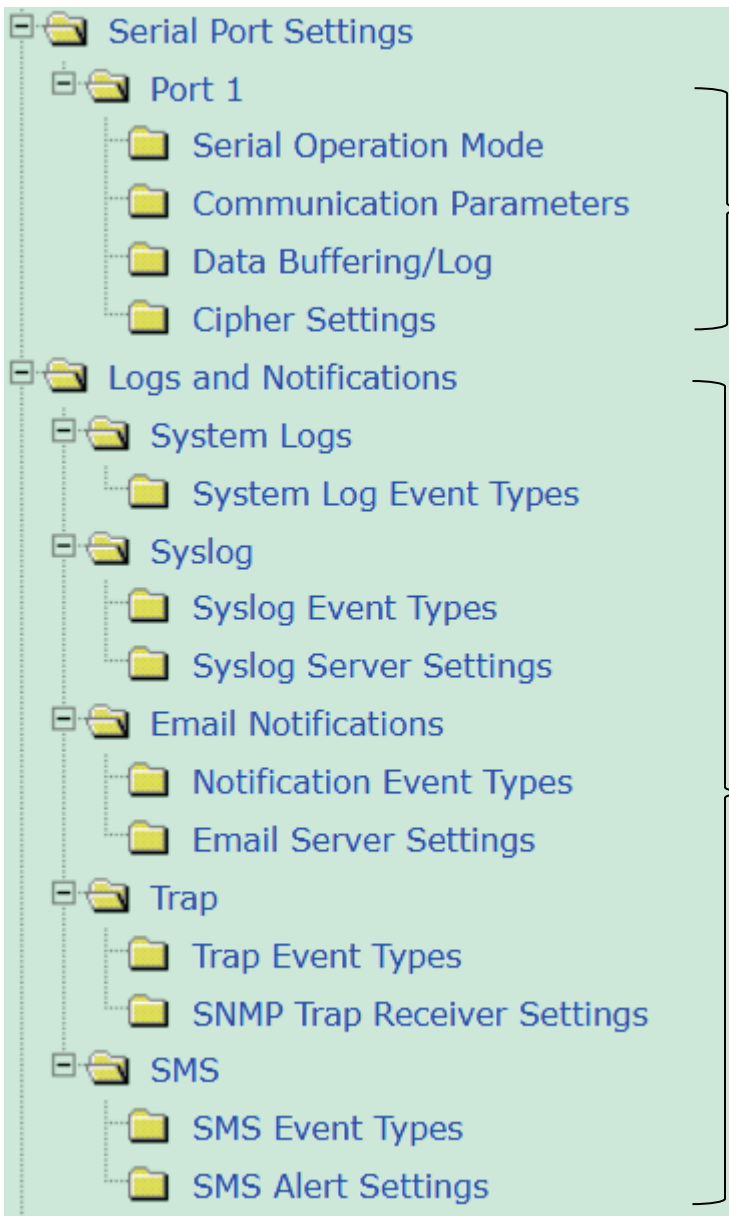

Serial port's operation mode and additional features to support serial operation mode such as Real COM, Reverse Real COM, and RFC2217.

Application-oriented device management functions to set up events, traps, and responses via email and SNMP notification. Note: These functions are all optional.

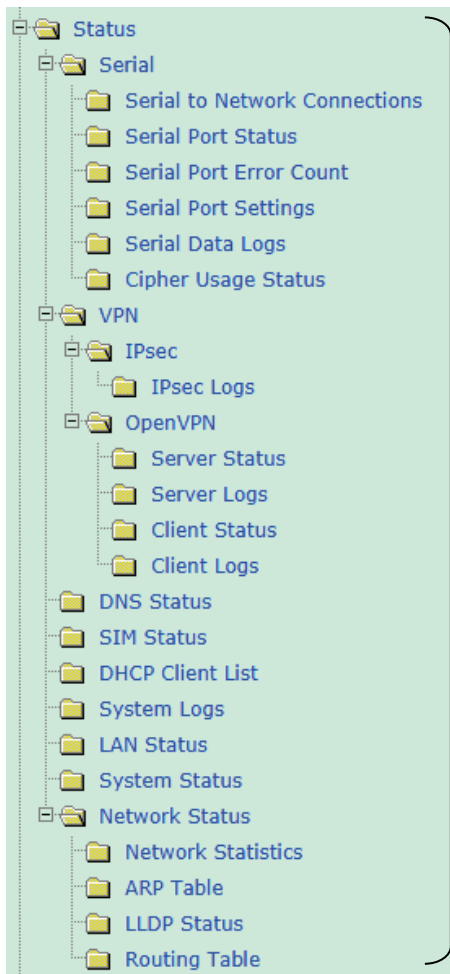

Current status information for monitoring wired/wireless network performance, advanced services, and device management functions.

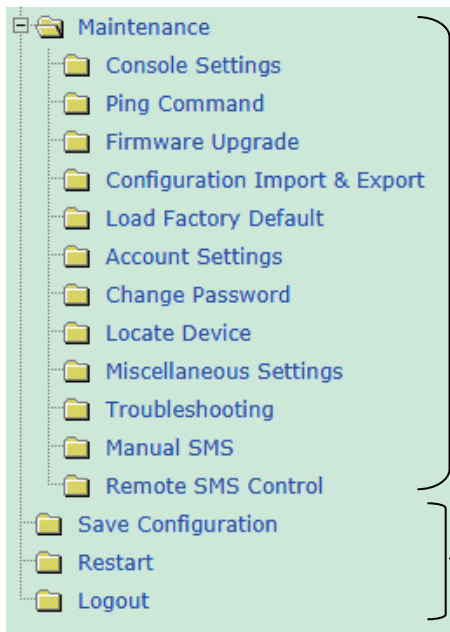

Functions for maintaining the OnCell 3120-LTE-1 and for diagnosing network issues

On-demand functions to support web console management



# Overview

The **Overview** page provides a summary of the OnCell 3120-LTE-1’s current status. The information is categorized into **System Information**, **Device Information**, and **Cellular Information**.

Overview (Warn: Change the default password to ensure a higher level of security)	
This screen displays current active settings	
<b>System Information</b>	
Model name	OnCell 3120-LTE-1-EU
Device name	OnCell 3120-LTE-1_78:98:A2
Serial number	TAIBB1084207
System uptime	0 days 00h:42m:02s
Firmware version	1.0 Build 19040113
<b>Device Information</b>	
Device MAC address	00:90:E8:78:98:A2
IP address	192.168.127.254
Subnet mask	255.255.255.0
<b>Cellular Information</b>	
Cellular mode	No service
Cellular RSSI	0
Cellular WAN IP address	0.0.0.0
IMEI	353251080022181
IMSI	N/A

# General Setup

The General Setup group includes the most commonly used settings required by administrators to maintain and control the OnCell 3120-LTE-1.

## System Information

The **System Info** items, especially **Device name** and **Device description**, are displayed and included on the **Overview** page, in SNMP information, and in alarm emails. Setting **System Info** items makes it easier to identify the different OnCell 3120-LTE-1 units connected to your network.

System Information	
Device name	<input type="text" value="OnCell 3120-LTE-1_78:98:A2"/>
Device location	<input type="text"/>
Device description	<input type="text"/>
Device contact information	<input type="text"/>
Login message	<input type="text"/>
Login authentication failure message	<input type="text" value="Invalid username or password"/>
<input type="button" value="Submit"/>	

Field	Description	Default setting
Device name	Enter a descriptive name (up to 31 characters). You can also include information that specifies the role or application of the OnCell 3120-LTE-1 unit.	OnCell 3120-LTE-1_[serial no]
Device location	Specify the location (up to 31 characters) of the OnCell 3120-LTE-1	N/A (Not applicable)

Field	Description	Default setting
<b>Device description</b>	Enter a description (up to 31 characters) for the OnCell 3120-LTE-1	N/A
<b>Device contact information</b>	Enter the contact information (up to 31 characters) of the person responsible for maintaining this OnCell 3120-LTE-1	N/A
<b>Login Message</b>	Enter the message (up to 31 characters) to display to the user who logs in into this OnCell 3120-LTE-1.	Blank
<b>Login authentication failure message</b>	Enter the message (up to 31 characters) that is displayed to the user when the login authentication fails.	Invalid username or password

## Interface On/Off

**Interface On/Off**

**LAN 1**  Enable  Disable

**LAN 2**  Enable  Disable

**Cellular WAN**  Enable  Disable

Field	Description	Default setting
<b>LAN</b>	Provides the capability to enable/disable the LAN interface	Enable
<b>Cellular WAN</b>	Provides the capability to enable/disable the cellular WAN interface.	Enable



### ATTENTION

Disabling the cellular WAN interface will disconnect access to remote cellular devices connected through the cellular WAN.

## Network Settings

You can use the **Network Settings** page to configure TCP/IP settings and the WAN Backup function for the OnCell 3120-LTE-1.

### Network Settings

#### Common Settings

<b>IP address</b>	<input type="text" value="192.168.127.254"/>
<b>Subnet mask</b>	<input type="text" value="255.255.255.0"/>

Field	Description	Default setting
<b>IP address</b>	Enter the unique IP address of the OnCell 3120-LTE-1.	192.168.127.254
<b>Subnet mask</b>	Enter the subnet mask to specify the type of network to which the OnCell 3120-LTE-1 is connected.	255.255.255.0

## WAN Backup

The WAN Backup feature provides WAN failover between cellular and Ethernet for serial-to-Internet applications. When the WAN Backup function is disabled, only the cellular WAN interface is connected to the

internet. If enabled, the Ethernet interface can be active as either the primary or backup WAN interface. Since all Ethernet ports are bridged on the same interface, any Ethernet port can act as a WAN interface to provide Internet connectivity for serial devices. If the connection on the primary WAN interface is unavailable, the connection will automatically switch to the backup WAN interface to connect to the Internet. Once the connection on the primary WAN is restored, the OnCell 3120-LTE-1 will switch back to the primary WAN interface.

**WAN Backup Settings**

**WAN Backup (Primary WAN)**  ▼  
**Alive Check Ping IP Address**   
**Alive Check Ping Interval**  (5 - 86400 seconds) (Default timeout: 5000 ms)  
**Ethernet Gateway**   
**Primary DNS server**   
**Secondary DNS server**

Field	Description	Default setting
<b>WAN Backup (Primary WAN)</b>	Enable or disable the WAN Backup feature. If enabled, select the primary WAN interface. Ethernet: Set an Ethernet interface as the primary WAN interface and cellular as the backup WAN interface to connect to the internet. Cellular: Set the cellular interface as the primary WAN interface and Ethernet as the backup WAN interface to connect to the internet.	Disable
<b>Alive Check Ping IP Address</b>	Enter the IP address of a remote host. The OnCell 3120-LTE-1 will ping the IP to check the status of the connection.	N/A
<b>Alive Check Ping Interval</b>	Specify the time (in seconds) the OnCell 3120-LTE-1 will wait before performing a ping connection check.	30
<b>Ethernet Gateway</b>	Enter the gateway IP address of the Ethernet WAN interface in order to communicate with external networks.	N/A
<b>Primary/Secondary DNS server</b>	Enter the IP address of the primary or secondary DNS server. After you specify a DNS server for a website, you can access the website by entering its URL instead of the IP address.	N/A

## IPv6 Management

The OnCell 3120-LTE-1 provides users the option to access the device’s configuration console through an IPv6 address. To use the OnCell 3120-LTE-1’s management and monitoring functions from a PC host, make sure that the PC host and the OnCell 3120-LTE-1 are on the same logical subnet.

**IPv6 Management**

**IPv6 Management**  ▼  
**IPv6 Address**   
**Prefix Length**

Field	Description	Default setting
<b>IPv6 Management</b>	Enable or disable the IPv6 management feature. If enabled, use the specified IPv6 address to access the OnCell 3120-LTE-1’s console for device management.	Disable
<b>IPv6 Address</b>	Enter the unique IPv6 address of the OnCell 3120-LTE-1.	2001:db8:1:ffff::c0a8:7ffe

Field	Description	Default setting
<b>Prefix Length</b>	<p>Enter the prefix length to specify the range of network to which the OnCell 3120-LTE-1 is connected.</p> <p>The prefix length in IPv6 is the equivalent of the subnet mask in IPv4. For example, a prefix length of 64 specified like: 2001:db8:1:ffff::c0a8:7ffe/64 tells the system to divide the network into 64 subnetworks. The subnet range is 2001:db8:1:ffff:0000:0000:0000:0000 - 2001:db8:1:ffff:ffff:ffff:ffff:ffff.</p>	64

## System Time

You can synchronize the system time on the OnCell 3120-LTE-1 based on an NTP (Network Time Protocol) server or user-specified date and time information. The OnCell 3120-LTE-1 includes the system time in system logs.

**NOTE** The OnCell 3120-LTE-1 includes a built-in real time clock (RTC). We strongly recommend that you update the **Current local time** for the OnCell 3120-LTE-1 after the initial setup or a long-term shutdown, especially when the network does not have an Internet connection for accessing the NTP server or if there is no NTP server on the LAN.

**System Time**

Date (YYYY/MM/DD)
Time (HH:MM:SS)

Current local time 1999 / 11 / 30 23 : 54 : 17

---

Time protocol: SNTP

Time zone: (GMT)Greenwich Mean Time: Dublin, Edinburgh, Lisbon, London ▼

Daylight saving time:  Enable

Time server 1:

Time server 2:

Time sync interval:  (600~9999 seconds)

Field	Description	Default setting
<b>Current local time</b>	<p>The fields indicate the current system time on the OnCell 3120-LTE-1.</p> <p>Enter the date and time in the format <i>yyyy/mm/dd hh:mm:ss</i></p> <p>To make the changes take effect, click <b>Set Time</b>. An "Updated" text appears to indicate that the change is complete.</p> <p><b>Note:</b> Set the time zone before you configure the current local time.</p>	N/A
<b>Time zone</b>	<p>Select a time zone from the drop-down list.</p> <p>The default option is GMT (Greenwich Mean Time).</p> <p><b>Note:</b> Changing the time zone automatically changes the <b>Current local time</b>. We strongly recommend that you set the time zone before you set the <b>Current local time</b>.</p>	N/A

Field	Description	Default setting
<b>Daylight saving time</b>	Select <b>Enable</b> to activate daylight saving time (DST) or summer time. When <b>Daylight saving time</b> is enabled, the following fields appear: <ul style="list-style-type: none"> <li>• <b>Starts at:</b> The date that daylight saving time begins.</li> <li>• <b>Stops at:</b> The date that daylight saving time ends.</li> <li>• <b>Time offset:</b> Indicates how many hours forward the clock should be advanced.</li> </ul>	N/A
<b>Time server 1/2</b>	Enter the IP address or the domain name of the primary or secondary NTP server.	time.nist.gov
<b>Time sync interval</b>	Specify how many seconds (600 to 9999) the OnCell 3120-LTE-1 must wait before requesting updates from the NTP server.	600

## Cellular Settings

This section describes the pages that you can use to configure cellular connection settings on the OnCell 3120-LTE-1:

- **Cellular Operation Mode**- Configure the OnCell 3120-LTE-1 as a router for IP data communication or as a modem to send and receive data via AT commands.
- **Cellular WAN Settings**-Configure these settings to establish a cellular connection.
- **GuaranLink Settings**-Use this page to configure Moxa’s proprietary 4-tier link protection that ensures reliable network connectivity.
- **Auto IP Report Settings**-If your service provider assigns a dynamic WAN IP address, you can configure this screen to set the OnCell 3120-LTE-1 to automatically send its WAN IP address to a specified host.
- **OnCell Central Manager Settings**-For details on the OnCell Central Manager setting, refer to the *OnCell Central Manager User’s Manual* available at [www.moxa.com](http://www.moxa.com).

## Cellular Operation Mode

### Cellular Operation Mode

**Cellular Operation Mode**

Cellular Operation Mode

---

### Cellular Operation Mode

**Cellular Operation Mode**

Cellular Operation Mode

Modem Type

Internet and SMS service will be disable under "Modem mode", including: 1. Internet service: Cellular WAN, Dual SIM, GuaranLink, OnCell Central Manager, DDNS, Packet Filters, VPN, Ping Command. 2.SMS: SMS alert, Remote SMS control, Manual SMS, Power Saving Mode - Sleep Mode.

---

Field	Description	Default setting
<b>Cellular Operation Mode</b>	<p>Select the operation mode of the OnCell device.</p> <p>Router mode: The OnCell 3120-LTE-1 works as an IP router for IP data communication.</p> <p>Modem mode: The OnCell 3120-LTE-1 works as a modem which can be controlled via AT commands for GSM/GPRS/SMS data transmissions.</p> <p><b>Note:</b> Modem mode is only supported by the OnCell 3120-LTE-1-EU Rev1.0.0 and OnCell 3120-LTE-1-AU Rev1.0.0 models.</p> <p>Please refer to <a href="#">Appendix D</a> for more information.</p>	Router mode
<b>Modem Type</b>	<p>If the Operation Mode is set to Modem Mode, select the type of modem.</p> <p>Serial modem: The OnCell device connects to the computer using the serial port interface.</p> <p>Virtual modem: The OnCell connects to the computer using the Ethernet port interface. A software-based virtual serial port needs to be created on the computer using Windows Driver Manager.</p> <p>Please refer to <a href="#">Appendix D</a> for more information.</p>	Serial modem

## Cellular WAN Settings

Configure the fields in the **Cellular WAN Settings** page to establish a 2G/3G/4G connection with a service provider.

The OnCell 3120-LTE-1 provides you with a scheduling function for managing your cellular connection. Depending on your application, you can use the scheduling function to specify when the radio should be turned on/off, when to disconnect the data transmission, or go into SMS-only mode and enable data transmission only during emergencies.

If you install two SIM cards in the OnCell 3120-LTE-1, you can select the Dual SIM mode and enable the GuaranLink feature to enable the OnCell 3120-LTE-1 to regularly check the connection quality and perform an automatic switchover in case the cellular connection is down. This setting ensures operation redundancy.

### Cellular WAN Settings

#### Cellular WAN Configuration

**SIM**  Ensure that the SIM cards are inserted in the correct slots.

**MTU**  (576 to 1500 Bytes)

Field	Description	Default setting
<b>SIM</b>	<p>Select a connection mode from the drop-down list.</p> <p>SIM 1—Select this option to establish a cellular connection using the SIM card installed in the SIM 1 slot.</p> <p>SIM 2—Select this option to establish a cellular connection using the SIM card installed in the SIM 2 slot.</p> <p>Dual SIM—Select this option if you want the OnCell 3120-LTE-1 to automatically establish a cellular connection using any one of the SIM cards. If you select the Dual SIM options, enable the GuaranLink feature to ensure optimum link quality and operation redundancy.</p>	SIM 1

Field	Description	Default setting
<b>MTU</b>	Set the Maximum Transmission Unit (MTU) value according to the restrictions of the cellular carrier. Make sure the end device is set to the same MTU value for better performance.  Note: Changing the MTU setting may result in longer boot times.	OnCell 3120-LTE-1-EU/AU: 1500 bytes OnCell 3120-LTE-1-US: 1428 bytes

**Cellular WAN Settings**

**Cellular WAN Configuration**

**SIM**   Ensure that the SIM cards are inserted in the correct slots.

**MTU**  (576 to 1500 Bytes)

**SIM 1 Configuration**

**SIM 1 PIN**

**SIM 1 band**

**SIM 1 username**

**SIM 1 password**

**SIM 1 APN**

**SIM 1 authentication type**

When using GSM/GPRS/EDGE capable SIM card, select corresponding bands to get better performance!

Field	Description	Default setting
<b>SIM 1 PIN</b> <b>SIM 2 PIN</b>	If configured, enter the PIN (numeric with up to 7 digits) to unlock the SIM card.  <b>Note:</b> A SIM card becomes locked if you enter an incorrect PIN more than three times.	N/A
<b>SIM 1 band</b> <b>SIM 2 band</b>	Select <b>Auto</b> to have the OnCell device automatically negotiate with the base station for the optimum cellular band frequency. Select <b>Manual</b> for the OnCell device to use a specific cellular band frequency.  <b>Note:</b> The OnCell device does not establish a cellular connection if your service provider does not support any of the bands you have selected.	Auto
<b>SIM 1 Service Provider</b> <b>SIM 2 Service Provider</b>	For OnCell 3120-LTE-1-EU/AU models, you do not need to select a service provider. For the OnCell 3120-LTE-1-US model, select a service provider for the SIM card.	OTHERS
<b>SIM 1 username</b> <b>SIM 2 username</b>	If configured, enter the username for authentication with your service provider.	N/A
<b>SIM 1 password</b> <b>SIM 2 password</b>	If configured, enter the password for authentication with your service provider. The length of the password can be up to 31 characters.	N/A
<b>SIM 1 APN</b> <b>SIM 2 APN</b>	Your service provider may use access point network (APN) information to provide different service levels. If configured, enter the access point network (APN) information.	N/A

Field	Description	Default setting
<b>SIM 1 authentication type/</b>	Select <b>None</b> if you want to set up a session without user authentication.	None
<b>SIM 2 authentication type</b>	Select <b>PAP</b> (Password Authentication Protocol) to send user name and password to the server and verify that the user name and password match with the server database.	
	Select <b>CHAP</b> (Challenge-Handshake Authentication Protocol) if the identifiers are changed frequently and if authentication can be requested by the server at any time. CHAP provides more security than PAP.	

## GuaranLink Settings

A number of factors can contribute to connection failures for cellular communications, including loss of cellular signal, interference, connection error caused by the base station, and termination by the operator for unknown reasons. Moxa’s proprietary GuaranLink feature, which is different from the basic heartbeat function, enables reliable connectivity with 4-tier intelligent connection checks without sending excessive and costly cellular packets.

### GuaranLink Recovery Process for Dual SIM Connections

The GuaranLink feature in OnCell 3120-LTE-1 automatically tries to re-establish a connection when a connection failure occurs by performing one of the following actions depending on the number of SIM cards enabled in the device:

- One SIM card: GuaranLink resets the cellular module without rebooting the device to force negotiation between the OnCell 3120-LTE-1 and the base station.
- Dual SIM cards: When the preferred SIM card fails to establish a connection, GuaranLink resets the cellular module without rebooting the device and establishes a cellular connection using the second SIM card account.
- If SIM 1 is chosen but SIM card is installed only in SIM 2 slot, no action will be performed. Please ensure that a SIM card is installed in the SIM card slot that you have selected for operation.
- If one of the SIM cards is not readable, GuaranLink will automatically force a cellular connection using the other SIM card account. The system log will record this event. If the second SIM card also cannot be read, GuaranLink will not try again.

## GuaranLink Settings

In the navigation panel, click **Cellular Settings > GuaranLink Settings** to display the configuration screen.

**GuaranLink Settings**

**GuaranLink**  Enable  Disable

**Common Settings**

**Register to network timeout**  (10 to 600 mins)

**Data session retry count**  (1 to 5/3 mins)

**Auto reboot**  Enable  Disable

**Module recovery retry count**  (4 to 30)

**DNS/Ping remote host 1**

**DNS/Ping remote host 2**

**Warning:** "DNS/Ping remote host" are only for "Cellular connection alive check"/"Packet-level connection check".

**GuaranLink Check Settings**

**ISP initial connection check**  Enable  Disable



### ISP Initial Connection Check (Default)

Register to base station



### Data Session Retry (Default)

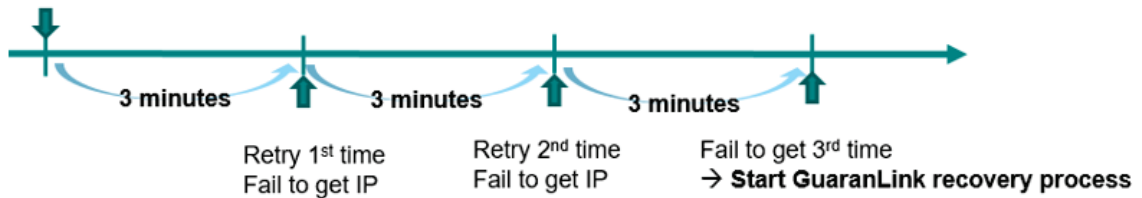

The following table describes the fields:

Field	Description	Default setting
<b>GuaranLink</b>	Select <b>Enable</b> to activate the GuaranLink feature. For operation redundancy, enable GuaranLink with <b>Dual SIM</b> mode so that the OnCell 3120-LTE-1 regularly checks the connection quality and performs an automatic switchover in case a cellular connection is down. Select <b>Disable</b> to deactivate the GuaranLink feature.	Enable
<b>Register to network timeout</b>	This field is used by the ISP initial connection check. Enter the time period (10–600 minutes) that the OnCell 3120-LTE-1 must wait before terminating the connection to an ISP and starting the GuaranLink recovery process.	10
<b>Data session retry count</b>	Enter the number of times (1 to 5; default is 3) the OnCell 3120-LTE-1 is to request an IP address from the ISP. If the OnCell 3120-LTE-1 fails to obtain an IP address after 3 tries (default value), it starts the GuaranLink recovery process. The time interval between each retry is 3 minutes.	3
<b>Auto reboot</b>	Select Enable to activate the auto reboot function. If the network does not recovery after resetting the module a certain number of times, this function reboots the device to recovery the system.	Enable
<b>Module recovery retry count</b>	Enter the number of times (4 to 30) the OnCell 3120-LTE-1 is to reset the module to recovery the network. If the OnCell 3120-LTE-1 fails to recovery the network after 5 retries (default value), it reboots the device to recovery the system.	5
<b>DNS/Ping remote host 1/2</b>	This field is used for cellular connection alive <b>and</b> packet-level connection checks. Enter the IP address or domain name of a remote host to ping or for a DNS lookup test. To ensure accurate checks, we suggest entering the host domain name here. For details, refer to <b>Packet-level connection check action</b> .	N/A

Field	Description	Default setting
<b>ISP initial connection check</b>	Select <b>Enable</b> to set the OnCell 3120-LTE-1 to complete the registration process to a base station before the timeout specified in the <b>Register to network timeout</b> field. If the OnCell 3120-LTE-1 fails to register to the base station within the timeout period, it starts the GuaranLink recovery process. Select <b>Disable</b> to allow the OnCell 3120-LTE-1 to wait until base station registration is successful.	Disable

Cellular connection alive check

Enable  Disable

Cellular connection alive check interval

5 (1 to 600 mins)

Cellular connection alive check retry count

3 (1 to 5/15 secs)

Packet-level connection check

Enable  Disable

Packet-level connection check action

DNS and Ping

Packet-level connection check interval

5 (1 to 600 mins)

Packet-level connection check retry count

3 (1 to 5/15 secs)

Transmission connection check

Enable  Disable

Transmission connection alive check interval

5 (1 to 600 mins)

### Cellular Connection Alive Check (Default)

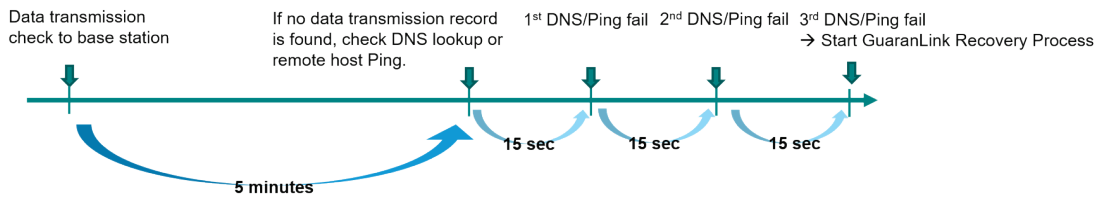

### Packet-Level Connection Check (Default)

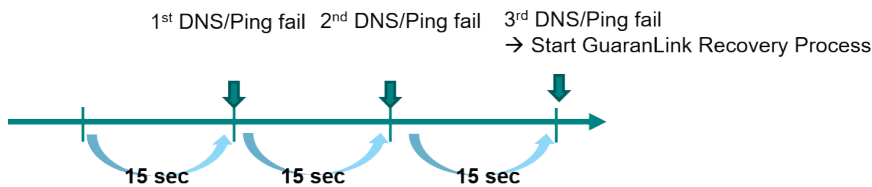

### Transmission Connection Check (Default)

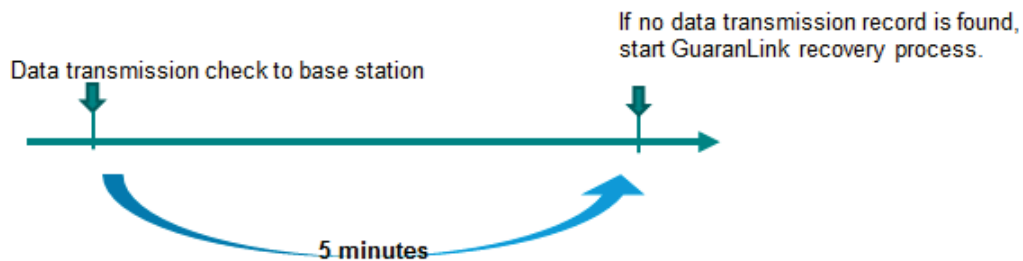

Field	Description	Default setting
<b>Cellular connection alive check</b>	Depending on your ISP, cellular connection is terminated if there is no active data transmission for a certain period of time. Select <b>Enable</b> to set the OnCell 3120-LTE-1 to keep the cellular connection alive by performing a DNS lookup or remote host Ping (host 1 is checked first; if the check fails, host 2 is checked), if no data is transmitted within the timeout period. For details, check the <b>Packet-level connection check action</b> . If the connection check fails after the number of retries specified in the <b>Cellular connection alive retry count</b> field, the OnCell 3120-LTE-1 starts the GuaranLink recovery process.	Disable
<b>Cellular connection alive check interval</b>	Enter the time (between 1 to 600 minutes) the OnCell 3120-LTE-1 is to wait before performing a connection check.	5
<b>Cellular connection alive check retry count</b>	Enter the number of times the OnCell 3120-LTE-1 is to try the connection check with approximately 15-second time interval between each retry. If the connection check fails, the OnCell 3120-LTE-1 starts the GuaranLink recovery process.	3
<b>Packet-level connection check</b>	Select <b>Enable</b> to check whether the cellular network is accessible using DNS lookup and remote host ping, <i>regardless of any existing data transmission</i> . If the connection check fails after the number of retries specified in the <b>Packet-level connection check retry count</b> field, the OnCell 3120-LTE-1 starts the GuaranLink recovery process.	Disable
<b>Packet-level connection check action</b>	Select one of the following options to determine if the connection check is successful: <ul style="list-style-type: none"> <li>• <b>DNS and Ping</b> – Response from both the DNS server and remote host. If an IP address is entered, the OnCell device will ping the IP to check the connection. If a host name is entered, the OnCell will check the DNS and also ping the host IP.</li> <li>• <b>DNS or Ping</b> – Response from either the DNS server or the remote host. If an IP address is entered, the OnCell device will ping the IP to check the connection. If a host name is entered, the OnCell will only check the DNS.</li> </ul>	DNS and Ping
<b>Packet-level connection check interval</b>	Enter the time (between 1 to 600 minutes) the OnCell 3120-LTE-1 is to wait before performing a connection check.	5
<b>Packet-level connection check retry count</b>	Enter the number of times the OnCell 3120-LTE-1 is to try the connection check (with approximately 15 seconds between each retry) before re-establishing the connection.	3
<b>Transmission connection check</b>	If a remote system regularly monitors connection to the OnCell 3120-LTE-1, select <b>Enable</b> to set the OnCell 3120-LTE-1 to receive polling information from the remote system at regular intervals. If no polling information is received within the timeout period, the OnCell 3120-LTE-1 starts the GuaranLink recovery process.	Disable
<b>Transmission connection alive check interval</b>	Enter the time (between 1 to 600 minutes) the OnCell 3120-LTE-1 is to wait for polling information from a remote system before starting the GuaranLink recovery process.	5

## Auto IP Report Settings

In MDVPN (mobile data virtual private network) applications where service providers set up private VPNs for enterprise customers, a cellular gateway must be assigned IP address that is visible to a remote host in a central office. In cases where a service provider assigns dynamic IP addresses, you can configure the **Auto IP Report Settings** screen to set the OnCell 3120-LTE-1 to regularly send its WAN IP address to a remote host.

**Auto IP Report Settings**

**Configuration**

**Auto IP report to host**

**Report to UDP port**

**Report period**  (1 - 65535 mins)

The following table describes the fields.

Field	Description	Default setting
<b>Auto IP report to host</b>	Enter the IP address of a remote host to which the OnCell 3120-LTE-1 is to send the WAN IP address information.	N/A
<b>Report to UDP port</b>	Enter the listing port number on the remote host.	63100
<b>Report period</b>	Enter the number of minutes the OnCell 3120-LTE-1 is to wait before sending WAN IP address information.	99

### Auto IP Report Format

The OnCell packet follows the "Type Length Value" format.

Type	Length	Value
1 byte	1 byte	Length bytes

The following table shows the Auto IP report format:

"Moxa", 4 bytes	Info[0]	Info[1]	...	Info[n]
-----------------	---------	---------	-----	---------

### Info [n]

Field	ID	Length	Data
<b>Length</b>	a	1	Variable, Length is "Length Field"

### ID List

ID Value	Description	Length	Note
1	Server Name	Variable	ASCII char
2	Hardware ID	2	Little-endian
3	MAC Address	6	6-byte MAC address. If the MAC address is "00-90-E8-01-02-03" then MAC[0] is 0, MAC[1] is 0x90(hex), MAC[2] is 0xE8(hex), etc.
4	Serial Number	4, DWORD	Little-endian
5	IP Address	4, DWORD	Little-endian (LAN IP)
9	AP ID	4, DWORD	Little-endian
10	IP Address2	4, DWORD	Little-endian (WAN IP)
11	Signal Level	1	Unsigned char
12	RSSI	1	Unsigned char

**Example:**

ID Value	Length	Note
05	04	C0,a8,81,71
09	04	30,12,19,89
0a	04	C0,a8,81,71
----	----	----

## OnCell Central Manager Settings

For the OnCell Central Manager settings, refer to the *OnCell Central Manager User's Manual*, which can be downloaded from [www.moxa.com](http://www.moxa.com).

## Advanced Settings

Several advanced functions are available to increase the functionality of your OnCell 3120-LTE-1 and wireless network system. The DHCP server helps you deploy wireless clients efficiently. Packet filters provide security mechanisms, such as firewalls, in different network layers. In addition, SNMP support can make network management easier.

### DHCP Server

DHCP (Dynamic Host Configuration Protocol) is a networking protocol that allows administrators to assign temporary IP addresses to network computers by "leasing" an IP address to a user for a limited amount of time, instead of assigning permanent IP addresses.

The OnCell 3120-LTE-1 can act as a DHCP server and assign IP addresses to your DHCP clients by responding to DHCP requests from the clients. The IP-related parameters you set on this page will also be sent to the client.

You can also assign a static IP address to a specific client by entering its MAC address. The OnCell 3120-LTE-1 provides a **Static DHCP mapping** list with up to 16 entities. Be reminded to check the **Active** check box for each entity to activate the setting.

You can check the IP assignment status in the **DHCP Client List** screen (click **Status > DHCP Client List**).

**DHCP Server**

DHCP server

Default gateway

Subnet mask

Primary DNS server

Secondary DNS server

Start IP address

Maximum number of users

Client lease time  (1~10 days)

**Static DHCP Mapping**

No.	<input type="checkbox"/> Active	IP Address	MAC Address
1	<input type="checkbox"/>	<input type="text"/>	<input type="text"/>
2	<input type="checkbox"/>	<input type="text"/>	<input type="text"/>
3	<input type="checkbox"/>	<input type="text"/>	<input type="text"/>
4	<input type="checkbox"/>	<input type="text"/>	<input type="text"/>
5	<input type="checkbox"/>	<input type="text"/>	<input type="text"/>
6	<input type="checkbox"/>	<input type="text"/>	<input type="text"/>
7	<input type="checkbox"/>	<input type="text"/>	<input type="text"/>
8	<input type="checkbox"/>	<input type="text"/>	<input type="text"/>

The following table provides the field descriptions:

Field	Description	Default setting
<b>DHCP server</b>	Select <b>Enable</b> to set the OnCell 3120-LTE-1 as a DHCP server. Select <b>Disable</b> to set the OnCell 3120-LTE-1 as a DHCP client.	Disable
<b>Default gateway</b>	Enter the IP address of the default gateway that connects to an outside network.	N/A
<b>Subnet mask</b>	Enter the subnet mask to specify the type of network for the DHCP clients.	N/A
<b>Primary/Secondary DNS server</b>	Enter the IP address of the primary or secondary DNS server. After you specify a DNS server, you can access a web site by entering its URL instead of the IP address.	N/A
<b>Start IP address</b>	Enter the starting IP address in the IP address pool.	N/A
<b>Maximum number of users</b>	Enter the number (between 1 and 999) of IP address to assign to DHCP clients.	N/A
<b>Client lease time</b>	Enter the lease time (between 1 to 10 days) for an assigned IP address. The IP address expired after the lease time.	10
<b>Static DHCP Mapping</b>	Local IP address and the MAC address of the connected devices (up to 16 devices) that obtain their IP address through DHCP.	N/A

## DDNS

If a DHCP server assigns an IP address to the OnCell 3120-LTE-1, you can configure dynamic DNS (DDNS) setting on the OnCell 3120-LTE-1 to allow remote servers to access the OnCell 3120-LTE-1 using its domain name instead of IP address. For more information on DDNS, see *Appendix C*.

Click **Advanced Settings > DDNS** to display the configuration screen.

**DDNS**

**DDNS function** Disable ▾

**Service provider** no-ip.org ▾

**Host name**

**Username**

**Password**

---

The following table provides the field descriptions:

Field	Description	Default setting
<b>DDNS function</b>	Select Enable to activate the DDNS feature.	Disable
<b>Service provider</b>	Select an option from the drop-down list.	N/A
<b>Host name</b>	Enter the host name that you created with the service provider.	N/A
<b>Username</b>	Enter the username for update authentication.	N/A
<b>Password</b>	Enter the password for update authentication.	N/A

## Packet Filters

The OnCell 3120-LTE-1 includes various filters for **IP-based** packets going through LAN and WLAN interfaces. You can set these filters as a firewall to help enhance network security.

### MAC Filter

The OnCell 3120-LTE-1’s MAC filter is a policy-based filter that can allow or filter out IP-based packets with specified MAC addresses. The OnCell 3120-LTE-1 provides 32 entities for setting MAC addresses in your filtering policy. Remember to check the **Active** check box for each entity to activate the setting.

**MAC Filters**

**MAC filters function** Disable ▾

**Policy** Drop ▾

No.	<input type="checkbox"/> Active	Name	MAC Address
1	<input type="checkbox"/>	<input style="width: 100%;" type="text"/>	<input style="width: 100%;" type="text"/>
2	<input type="checkbox"/>	<input style="width: 100%;" type="text"/>	<input style="width: 100%;" type="text"/>
3	<input type="checkbox"/>	<input style="width: 100%;" type="text"/>	<input style="width: 100%;" type="text"/>
4	<input type="checkbox"/>	<input style="width: 100%;" type="text"/>	<input style="width: 100%;" type="text"/>
5	<input type="checkbox"/>	<input style="width: 100%;" type="text"/>	<input style="width: 100%;" type="text"/>
6	<input type="checkbox"/>	<input style="width: 100%;" type="text"/>	<input style="width: 100%;" type="text"/>
7	<input type="checkbox"/>	<input style="width: 100%;" type="text"/>	<input style="width: 100%;" type="text"/>
8	<input type="checkbox"/>	<input style="width: 100%;" type="text"/>	<input style="width: 100%;" type="text"/>

Field	Description	Default setting
<b>MAC filters function</b>	Select <b>Enable</b> to enable MAC filtering.	Disable
<b>Policy</b>	Select <b>Accept</b> to allow packets that meet the specified criteria. Select <b>Drop</b> to deny packets that meet the specified criteria.	Drop



**ATTENTION**

Be careful when you enable the filter function:

**Drop** + "no entity on list is activated" = all packets are **allowed**

**Accept** + "no entity on list is activated" = all packets are **denied**

**IP Protocol Filter**

The OnCell 3120-LTE-1's IP protocol filter is a policy-based filter that can allow or filter out IP-based packets with specified IP protocol and source/destination IP addresses.

The OnCell 3120-LTE-1 provides 32 entities for setting IP protocol and source/destination IP addresses in your filtering policy. Four IP protocols are available: **All**, **ICMP**, **TCP**, and **UDP**. You must specify either the Source IP or the Destination IP. By combining IP addresses and netmasks, you can specify a single IP address or a range of IP addresses to accept or drop. For example, "IP address 192.168.1.1 and netmask 255.255.255.255" refers to the sole IP address 192.168.1.1. "IP address 192.168.1.1 and netmask 255.255.255.0" refers to the range of IP addresses from 192.168.1.1 to 192.168.1.255. Remember to check the **Active** check box for each entity to activate the setting.

**IP Protocol Filters**

IP protocol filters function: Disable ▾

Policy: Drop ▾

No.	<input type="checkbox"/> Active	Protocol	Source IP	Source Netmask	Destination IP	Destination Netmask
1	<input type="checkbox"/>	All ▾				
2	<input type="checkbox"/>	All ▾				
3	<input type="checkbox"/>	All ▾				
4	<input type="checkbox"/>	All ▾				
5	<input type="checkbox"/>	All ▾				
6	<input type="checkbox"/>	All ▾				
7	<input type="checkbox"/>	All ▾				
8	<input type="checkbox"/>	All ▾				

Field	Description	Default setting
<b>IP protocol filters function</b>	Select <b>Enable</b> to enable IP protocol filtering.	Disable
<b>Policy</b>	Select <b>Accept</b> to allow packets that meet the specified criteria. Select <b>Drop</b> to deny packets that meet the specified criteria.	Drop



**ATTENTION**

Be careful when you enable the filter function:

**Drop** + "no entity on list is activated" = all packets are **allowed**.

**Accept** + "no entity on list is activated" = all packets are **denied**.

**TCP/UDP Port Filter**

The OnCell 3120-LTE-1's TCP/UDP port filter is a policy-based filter that can allow or filter out TCP/UDP-based packets with a specified source or destination port.

The OnCell 3120-LTE-1 provides 32 entities for setting the range of source/destination ports of a specific protocol. In addition to selecting TCP or UDP protocol, you can set either the source port, destination port, or both. The end port can be left empty if only a single port is specified. Of course, the end port cannot be larger than the start port.



The **Application name** is a text string that describes the corresponding entity with up to 31 characters. Remember to check the **Active** check box for each entity to activate the setting.

**TCP/UDP Port Filters**

TCP/UDP port filters function Disable ▾

Policy Drop ▾

No.	<input type="checkbox"/> Active	Source Port	Destination Port	Protocol	Application Name
1	<input type="checkbox"/>	<input type="text"/> ~ <input type="text"/>	<input type="text"/> ~ <input type="text"/>	TCP ▾	<input type="text"/>
2	<input type="checkbox"/>	<input type="text"/> ~ <input type="text"/>	<input type="text"/> ~ <input type="text"/>	TCP ▾	<input type="text"/>
3	<input type="checkbox"/>	<input type="text"/> ~ <input type="text"/>	<input type="text"/> ~ <input type="text"/>	TCP ▾	<input type="text"/>
4	<input type="checkbox"/>	<input type="text"/> ~ <input type="text"/>	<input type="text"/> ~ <input type="text"/>	TCP ▾	<input type="text"/>
5	<input type="checkbox"/>	<input type="text"/> ~ <input type="text"/>	<input type="text"/> ~ <input type="text"/>	TCP ▾	<input type="text"/>
6	<input type="checkbox"/>	<input type="text"/> ~ <input type="text"/>	<input type="text"/> ~ <input type="text"/>	TCP ▾	<input type="text"/>
7	<input type="checkbox"/>	<input type="text"/> ~ <input type="text"/>	<input type="text"/> ~ <input type="text"/>	TCP ▾	<input type="text"/>
8	<input type="checkbox"/>	<input type="text"/> ~ <input type="text"/>	<input type="text"/> ~ <input type="text"/>	TCP ▾	<input type="text"/>

Field	Description	Default setting
<b>TCP/UDP port filters function</b>	Select <b>Enable</b> to enable TCP/UDP port filtering.	Disable
<b>Policy</b>	Select <b>Accept</b> to allow packets that meet the specified criteria. Select <b>Drop</b> to deny packets that meet the specified criteria.	Drop



**ATTENTION**

Be careful when you enable the filter function:

**Drop** + "no entity on list is activated" = all packets are **allowed**

**Accept** + "no entity on list is activated" = all packets are **denied**

OnCell device itself is NOT included within this policy.

For device interface access and security settings, go to **Maintenance → Console settings**.

## Port Forwarding Function

You can configure port forwarding settings on the OnCell 3120-LTE-1 to redirect specific packets from a remote host on the WAN to a server on the LAN. This feature hides the IP address of a local server and prevents remote hosts from accessing the local server directly. Meanwhile, NAT loopback enables users to run a server inside the network, which can be accessed by the user in the local network using the public IP or domain name. The NAT loopback function is enabled by default.

The OnCell 3120-LTE-1 filters out unrecognized packets to protect your LAN network when computers connected to the OnCell 3120-LTE-1 are not visible to the WAN.

To access the Port Forwarding settings, select **Advanced Setup > Port Forwarding function**. The OnCell 3120-LTE-1 supports 128 port-forwarding rules.

**Port Forwarding function**

Port forwarding Disable ▾

No.	<input type="checkbox"/> Active	Protocol	WAN Port	LAN IP	LAN Port
1	<input type="checkbox"/>	TCP ▾	<input type="text"/>	<input type="text"/>	<input type="text"/>
2	<input type="checkbox"/>	TCP ▾	<input type="text"/>	<input type="text"/>	<input type="text"/>
3	<input type="checkbox"/>	TCP ▾	<input type="text"/>	<input type="text"/>	<input type="text"/>
4	<input type="checkbox"/>	TCP ▾	<input type="text"/>	<input type="text"/>	<input type="text"/>
5	<input type="checkbox"/>	TCP ▾	<input type="text"/>	<input type="text"/>	<input type="text"/>
6	<input type="checkbox"/>	TCP ▾	<input type="text"/>	<input type="text"/>	<input type="text"/>
7	<input type="checkbox"/>	TCP ▾	<input type="text"/>	<input type="text"/>	<input type="text"/>
8	<input type="checkbox"/>	TCP ▾	<input type="text"/>	<input type="text"/>	<input type="text"/>

The following table includes the field descriptions:

Field	Description	Factory Default
<b>Port forwarding</b>	Select Enable to activate the port forwarding feature.	Disable
<b>Active</b>	Select this check box to activate the port forwarding entry.	unchecked
<b>Protocol</b>	Select an option from the drop-down list.	TCP
<b>WAN Port</b>	Enter the WAN port number. Make sure that the port number specified is not already used by other operation modes.	N/A
<b>LAN IP</b>	Enter the IP address of a LAN device to receive the redirected traffic.	N/A
<b>LAN Port</b>	Enter the port number on a LAN device to which to redirect the traffic to.	N/A

## SNMP Agent

The OnCell 3120-LTE-1 supports SNMP V1/V2c/V3. SNMP V1 and SNMP V2c use a community string match for authentication, which means that SNMP servers access all objects with read-only or read/write permissions using the community string **public/private** (default value). SNMP V3, which requires you to select an authentication level of MD5 or SHA, is the most secure protocol. You can also enable data encryption to enhance data security.

The OnCell 3120-LTE-1's MIB is available for download from Moxa's official website and supports reading the attributes via SNMP (only the SNMP GET method is supported.)

SNMP security modes and security levels supported by the OnCell 3120-LTE-1 are shown in the following table. Select the security mode and level that will be used to communicate between the SNMP agent and manager.

Protocol Version	Setting on UI web page	Authentication Type	Data Encryption	Method
SNMP V1, V2c	V1, V2c Read Community	Community string	No	Use a community string match for authentication
	V1, V2c Write/Read Community	Community string	No	Use a community string match for authentication
SNMP V3	No-Auth	No	No	Use account with admin or user to access objects
	MD5 or SHA	Authentication based on MD5 or SHA	No	Provides authentication based on HMAC-MD5, or HMAC-SHA algorithms. 8-character passwords are the minimum requirement for authentication.
	MD5 or SHA	Authentication based on MD5 or SHA	Data encryption key	Provides authentication based on HMAC-MD5 or HMAC-SHA algorithms, and data encryption key. 8-character passwords and a data encryption key are the minimum requirements for authentication and encryption.

The following parameters can be configured on the **SNMP Agent** page.

<b>SNMP Agent</b>	
<b>SNMP agent</b>	Disable ▾
<b>Remote management</b>	Disable ▾
<b>Read community</b>	public
<b>Write community</b>	private
<b>SNMP agent version</b>	V1, V2c ▾
<b>Admin authentication type</b>	No Auth ▾
<b>Authentication username</b>	admin ▾
<b>Admin encryption method</b>	Disable ▾
<b>Private key</b>	
<b>Private MIB information</b>	
<b>Device object ID</b>	enterprise.8691.15.32

Field	Description	Default Setting
<b>SNMP agent</b>	Select <b>Enable</b> to activate SNMP agent.	Disable
<b>Remote management</b>	Select <b>Enable</b> to allow remote management via SNMP agent.	Disable
<b>Read community</b>	Enter the community string or password (up to 31 characters long) for an SMNP agent to access objects with read-only permission.	public
<b>Write community</b>	Enter the community string or password (up to 31 characters long) for an SMNP agent to access objects with read-write permission.	private
<b>SNMP agent version</b>	Select the SNMP protocol version used to manage the OnCell 3120-LTE-1.	V1, V2c
<b>Admin authentication type</b>	Select <b>No Auth</b> to use an administrator account to access objects without authentication. Select <b>MD5</b> to authenticate using HMAC-MD5 algorithms where the minimum requirement is to use an 8-character password. Select <b>SHA</b> to authenticate using HMAC-SHA algorithms where the minimum requirement is to use an 8-character password.	No Auth
<b>Authentication username</b>	The username to use for SNMP authentication	admin
<b>Admin encryption method</b>	Select <b>Disable</b> for no data encryption Select <b>DES</b> to use DES-based data encryption Select <b>AES</b> to use AES-based data encryption	Disable
<b>Private key</b>	Enter the key (up to 63 characters) for data encryption	N/A
<b>Private MIB information Device object ID</b>	The object ID (OID) is the enterprise value for the OnCell 3120-LTE-1. This value is not configurable.	N/A

## VPN

Computers that are part of a virtual private network (VPN) use a second, "virtual" IP address to connect to the Internet. Instead of running across a single private network, some of the links between nodes that are part of a VPN use open network connections or virtual circuits on a larger network, such as the Internet. The OnCell 3120-LTE-1 can act as a VPN client or VPN server. Once the connection is established, cellular devices can communicate with other network devices on the same private network.

The following figure shows an example of a network topology:

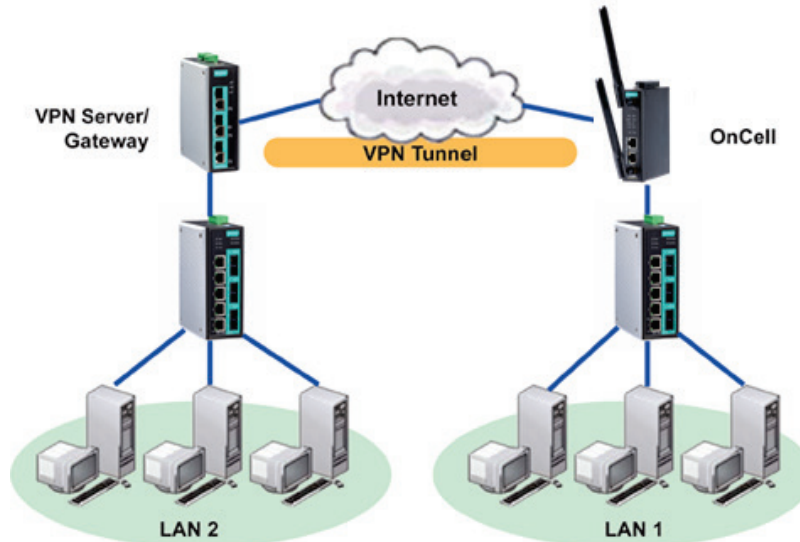

## IPsec

### Overview—OnCell 3120-LTE-1 IPsec Feature

The IPsec feature on the OnCell 3120-LTE-1:

- Provides Layer-3 (IP-layer) security in a network with gateway-to-gateway topology as illustrated in the following figure
- Initiates a VPN connection from the OnCell 3120-LTE-1 to a VPN Server
- Operates in Tunnel mode with **IPsec VPN tunnel**:
  - Manual Key/ESP, IKE/PSK encryption
  - DES/3DES/AES128 encryption
  - MD5/SHA1 authentication
- Provides IPsec NAT traversal and PFS (perfect forwarding secrecy)
- Provides IPsec over GRE protocol

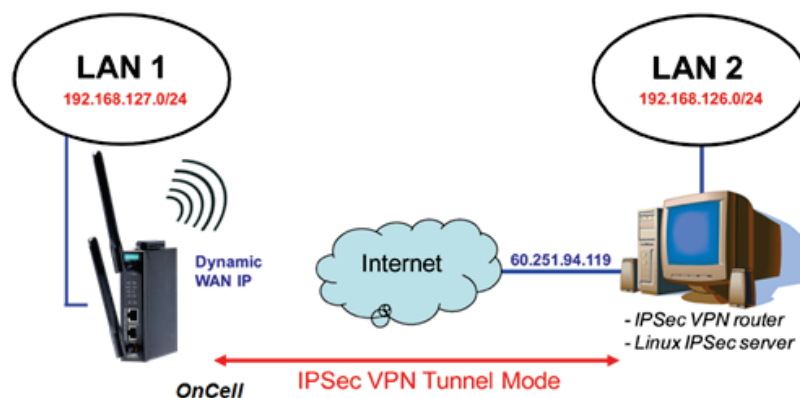

## IPsec Settings

You can enable or disable the IPsec and NAT traversal functions and configure up to five VPN tunnels by selecting **Advanced Settings > VPN > IPsec Settings**.

**IPsec Settings**

---

**IPsec** Disable ▾

**NAT traversal** Disable ▾ **Please enable NAT traversal at both peers of IPsec tunnel to successfully establish data communication.**

---

Status	Name	Remote Endpoint	Local Subnet	Remote Subnet	Action
Disabled					<input type="button" value="Edit"/> <input type="button" value="Delete"/>
Disabled					<input type="button" value="Edit"/> <input type="button" value="Delete"/>
Disabled					<input type="button" value="Edit"/> <input type="button" value="Delete"/>
Disabled					<input type="button" value="Edit"/> <input type="button" value="Delete"/>
Disabled					<input type="button" value="Edit"/> <input type="button" value="Delete"/>

The following table provides the field descriptions.

Field	Description	Factory Default
<b>IPsec</b>	Select <b>Enable</b> to activate the IPsec feature.	Disable
<b>NAT Traversal</b>	Select <b>Enable</b> to activate the NAT traversal feature that allows IPsec traffic to traverse through NAT-enabled devices. Make sure that the remote VPN device supports this feature.	Disable
<b>Action</b>	Click <b>Edit</b> to configure a VPN tunnel. Click <b>Delete</b> to remove the selected VPN tunnel.	

### Configuring a VPN Tunnel

To configure a VPN tunnel, click **Edit** in the **IPsec Settings** screen.

**Tunnel Settings**

**IPSec enable** Disable ▾

**Connection name**  (Must begin with an alphabet)

**Connection type** Site to Site ▾

**Startup mode** Start in Initial ▾

**Remote VPN gateway**

**Local network**

**Local netmask**

**Local ID**

**Remote network**

**Remote netmask**

**Remote ID**

**NAT type** None ▾

**GRE enable** Disable ▾

None ▾

None

Local 1:1 NAT

Local 1:N NAT

The following table provides the field descriptions:

Field	Description	Factory Default
<b>IPsec enable</b>	Select <b>Enable</b> to activate the VPN tunnel.	Disable
<b>Connection name</b>	Enter a descriptive name for the VPN tunnel.	-
<b>Connection type</b>	Select one of the following connection types: <ul style="list-style-type: none"> <li>• <b>Site-to-Site</b> – Select this option to create a VPN tunnel for static local and remote subnets.</li> <li>• <b>Site-to-Site (any)</b> – Select this option to create a VPN tunnel between a static local subnet and a dynamic remote subnet.</li> </ul>	Site-to-Site
<b>Startup mode</b>	Select <b>Start in Initial</b> to set the OnCell 3120-LTE-1 to initiate a connection with the remote VPN gateway. Select <b>Wait for Connecting</b> to set the OnCell 3120-LTE-1 to wait for a remote VPN gateway to initiate a connection.	Start in Initial
<b>Remote VPN gateway</b>	Enter the WAN IP address of the remote VPN gateway.	N/A
<b>Local network</b>	Enter the IP of the local network.	N/A
<b>Local netmask</b>	Enter the netmask of the local network.	N/A
<b>Local ID</b>	Enter an ID (IP/FQDN/User_FQDN) to identify and authenticate the local VPN gateway.	N/A
<b>Remote network</b>	Enter the IP of the remote network.	N/A
<b>Remote netmask</b>	Enter the netmask of the remote network.	N/A
<b>Remote ID</b>	Enter an ID (IP/FQDN/User_FQDN) to identify and authenticate the remote VPN endpoint.	N/A
<b>NAT type</b>	Select this check box to activate 1:1 or 1:N network address translation (NAT) Local 1:1 NAT—Virtual IP addresses are used for communication via the VPN tunnel. These addresses are linked to the real IP addresses for the network that has been connected. The subnet mask remains unchanged. Local 1:N NAT—The device has one IP address, which can be used to access the device externally. For incoming data packets, the device can convert the specified sender WAN port to internal IP address. For example, this function can be used to enable PLCs from different sites to have the same IP address.	None
<b>GRE enable</b>	Enables generic routing encapsulation (GRE) in IPsec tunneling.	Disable

**Key Exchange (Phase1)**

Operation mode: Main

Authentication mode: Pre-shared Key

Encryption algorithm: 3DES

Hash algorithm: MD5

DH group: DH-2

Negotiation times: 0 (0:forever)

IKE life time: 60 min.

Rekey expire time: 9 min.

Rekey fuzz percentage: 100 %

---

**Data Exchange (Phase2)**

Perfect forward secrecy: Disable

SA life time: 480 min.

Encryption algorithm: 3DES

Hash algorithm: MD5

---

**Dead Peer Detection**

DPD action: Disable

DPD delay: 30 seconds

DPD timeout: 120 seconds

Field	Description	Factory Default
<b>Key Exchange (Phase1)</b>		
<b>Operation mode</b>	Select main <b>mode</b> or <b>aggressive</b> mode to configure the standard negotiation parameters for IKE Phase 1 of the VPN Tunnel.	Main
<b>Authentication mode</b>	Select <b>Pre-shared key</b> , <b>RSA Signature</b> , or <b>X.509</b> authentication mode to for phase 1 key exchange. The configuration fields vary depending on the authentication mode you select. For information on configuring each authentication mode, refer to the respective sections in this guide.	Pre-shared key
<b>Encryption algorithm</b>	Select the DES, 3DES or AES128 algorithm for the VPN ISAKMP phase 1 encryption mode.	3DES
<b>Hash algorithm</b>	Select the MD5 or SHA-1 VPN key exchange phase 2 hash mode.	MD5
<b>DH group</b>	Select the DH-2(1024) or DH-5(1536) VPN key exchange phase 1 Diffie-Hellman group. As the Diffie-Hellman Group number increases, the higher the level of encryption implemented for PFS.	DH-2
<b>Negotiation times</b>	The number of allowed reconnect times when startup mode is initiated. If the number is 0, this tunnel will always try connecting to the remote gateway when the VPN tunnel is not created successfully.	0
<b>IKE life time</b>	Enter the number of minutes for the VPN IKE SA phase 1 Lifetime. This is the period of time to pass before establishing a new IPsec security association (SA) with the remote endpoint.	60
<b>Rekey expire time</b>	Enter the number of minutes for the Start to Rekey before IKE lifetime expired.	9

Field	Description	Factory Default
<b>Rekey fuzz percent</b>	The rekey expire time will change randomly to enhance the security. Rekey fuzz percent is the maximum random change margin of the Rekey expire time. 100% means the rekey expire time will not change randomly.	100%
<b>Data Exchange (phase2)</b>		
<b>Perfect forward secrecy</b>	Enable or disable the Perfect Forward Secrecy. PFS is an additional security protocol.	Disable
<b>SA life time</b>	Enter the number of seconds for the VPN ISAKMP phase 2 Lifetime. This is the period of time to pass before establishing a new IPsec security association (SA) with the remote endpoint.	480
<b>Encryption algorithm</b>	Select the DES, 3DES, or AES128 algorithm for the VPN ISAKMP phase 1 encryption mode.	3DES
<b>Hash algorithm</b>	Select the MD5 or SHA-1 VPN ISAKMP phase 1 authentication mode.	MD5
<b>Dead Peer Detection</b>		
<b>DPD action</b>	When you enable the Dead Peer Detection (DPD) feature, the OnCell 3120-LTE-1 performs one of the following actions when connection to a remote IPsec tunnel is down: <ul style="list-style-type: none"> <li>• Hold: Keep the VPN tunnel</li> <li>• Clear: Clear the VPN tunnel</li> <li>• Restart: Re-establish the VPN tunnel on Start in Initial mode.</li> <li>• Restart by Peer: Re-establish the VPN tunnel on Wait for connecting mode.</li> </ul>	Disable
<b>DPD delay</b>	The period of dead peer detection messages.	30
<b>DPD timeout</b>	Timeout to check if the connection is alive or not.	120

### Configuring Pre-Shared Key Settings

To configure pre-shared key authentication mode in phase 1 key exchange, in the **Tunnel settings** screen, select **Pre-shared key** from the **Authentication mode** drop-down list. Then, enter a key in the text field.

Make sure that you configure the same key on the OnCell 3120-LTE-1 and the remote VPN gateway.

### Configuring RSA Signature Settings

To configure RSA signature settings, complete the following steps:

1. In the Tunnel Settings screen, select RSA Signature from the Authentication mode drop-down list.
2. Generate or import a local private key. Perform one of the following actions:
  - Click **Generate Local Private Key**. The OnCell 3120-LTE-1 creates a private key and displays the key information in the **Local private key** field.
  - Click **Import Local Private Key** and select a key file to import. After the OnCell 3120-LTE-1 successfully imports the selected key, the system displays the key information in the **Local private key** field.
3. Generate or import a remote private key. Perform one of the following actions:
  - Click **Generate Remote Public Key**. The OnCell 3120-LTE-1 creates a public key and displays the key information in the **Remote public key** field.
  - Click **Import Remote Public Key** and select a key file to import. After the OnCell 3120-LTE-1 successfully imports the selected key, the system displays the key information in the **Remote public key** field.



The following figure shows the certificate generation and certificate export/import example.

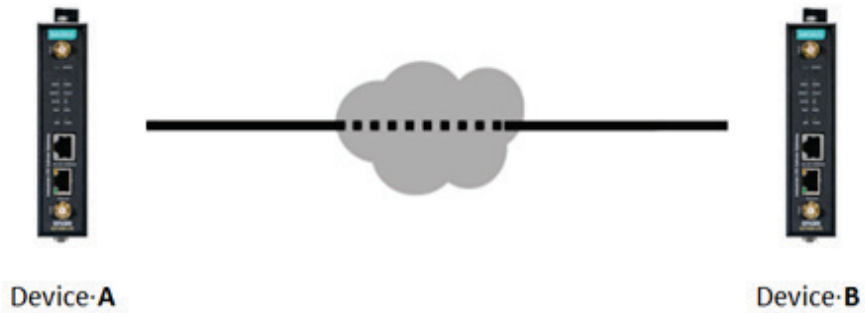

1. Generate Root CA
2. Generate Local Certificate
3. Click **PKCS#12 Export** to export the local certificate (*local\_CA\_A.p12*)
4. Click **Certificate Export** to export the local certificate file (*local\_CA\_A.pem*)
5. Click **VPN > X.509 > Local Certificate Upload** and import the local certificate (*local\_CA\_A.p12*).
6. Click **VPN > X.509 > Remote Certificate Upload** to import the remote certificate (*local\_CA\_B.pem*).

1. Generate Root CA
2. Generate Local Certificate
3. Click **PKCS#12 Export** to export the local certificate (*local\_CA\_B.p12*)
4. Click **Certificate Export** to export the local certificate file (*local\_CA\_B.pem*)
5. Click **VPN > X.509 > Local Certificate Upload** and import the local certificate (*local\_CA\_B.p12*).
6. Click **VPN > X.509 > Remote Certificate Upload** to import the remote certificate (*local\_CA\_A.pem*).

**Local 1:N NAT**

OnCell 3120-LTE-1 can support up to 32 TCP/UDP connections for 1:N network address translation (NAT).

Local 1:N NAT					
No	<input type="checkbox"/> Activate	Protocol	WAN Port	LAN IP	LAN Port
1	<input type="checkbox"/>	TCP ▾	<input type="text"/>	<input type="text"/>	<input type="text"/>
2	<input type="checkbox"/>	TCP ▾	<input type="text"/>	<input type="text"/>	<input type="text"/>
3	<input type="checkbox"/>	TCP ▾	<input type="text"/>	<input type="text"/>	<input type="text"/>
4	<input type="checkbox"/>	TCP ▾	<input type="text"/>	<input type="text"/>	<input type="text"/>
5	<input type="checkbox"/>	TCP ▾	<input type="text"/>	<input type="text"/>	<input type="text"/>
6	<input type="checkbox"/>	TCP ▾	<input type="text"/>	<input type="text"/>	<input type="text"/>

Field	Description	Default setting
<b>Activate</b>	Select this check box to activate the 1:N NAT	Always on
<b>Protocol</b>	Select the protocol to use in the NAT policy.	TCP
<b>WAN Port</b>	Enter the WAN port number to redirect to specific LAN IP. Make sure that the port number specified is not already used by OP modes.	N/A
<b>LAN IP</b>	Enter the IP address of a LAN device to receive the redirected traffic.	N/A
<b>LAN Port</b>	Enter the port number on a LAN device to which to redirect traffic.	N/A

### 1:N Concept

PC:192.168.0.1-----[VPN]---Internet---[Public-IP-VPN---192.168.100.1---NAT]-----192.168.1.1=>PLC{1}  
 -----Internet---[Public-IP-VPN---192.168.100.2---NAT]-----192.168.1.1=>PLC{2}

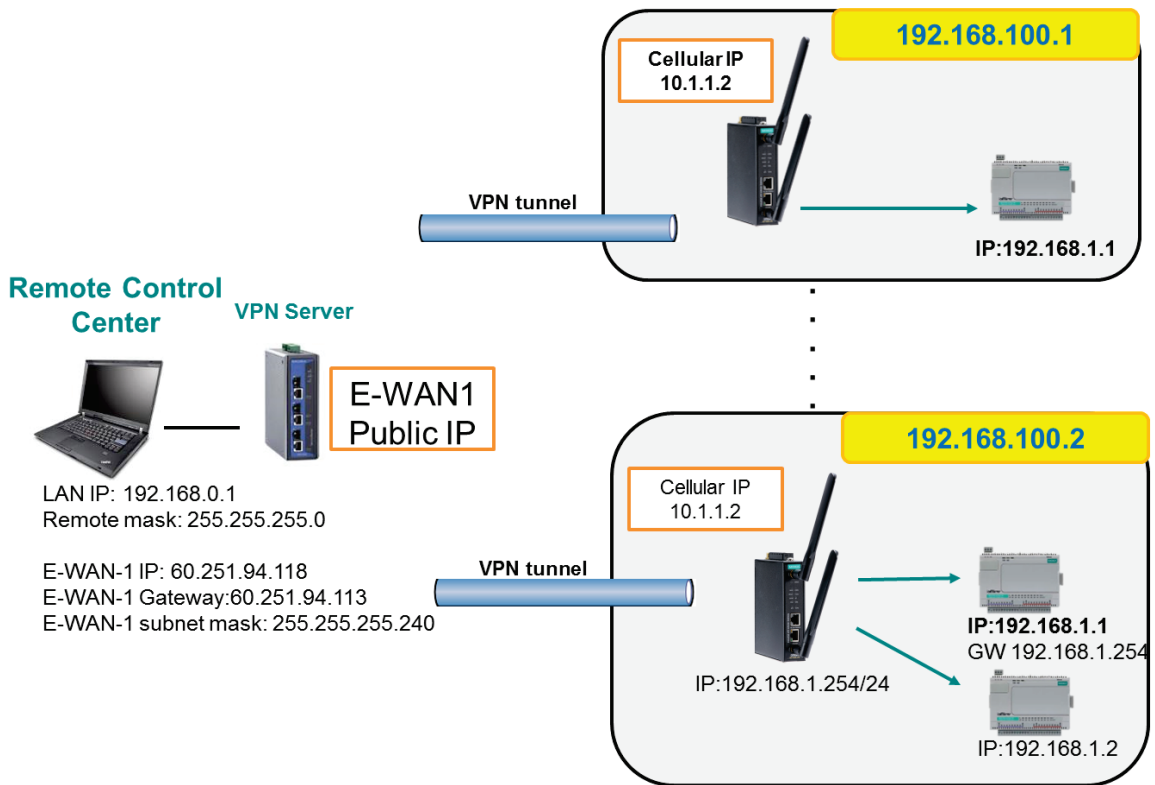

### X.509 Certificate

**NOTE** Before you configure X.509 settings, make sure that you have imported local and remote certificates in the **Local/Remote Certificate Upload** screen (click **Advanced Settings > VPN > X.509 Certificate > Local/Remote Certificate Upload**).

In the **Tunnel Settings** screen, select **X.509** from the **Authentication mode** drop-down list and select a certificate from the **Local certificate** and **Remote certificate** drop-down lists.

#### Certificate Generation

X.509 is a digital certificate method commonly used for IPsec authentication. You can generate a self-signed root CA or local certificate on the OnCell 3120-LTE-1 and import or export the certificate on a remote VPN gateway.

To display the **Certificate Generation** screen, click **Advanced Settings > VPN > X.509 Certificate > Certificate Generation**.

**Certificate Generation**

**Root Certificate Generation**

Certificate validity: 365 (days)

Certificate password (4 to 63 characters):

Country name (2 letter code):

State or province name (full name):

Locality (E.g., City):

Organization (E.g., Company):

Organizational unit (E.g., Section):

Name (E.g., server FQDN or your name): OnCell-G3150A-LTE

Email address:

Name	Subject	Action
Root CA		<input type="button" value="Delete"/>
Trusted CA1		<input type="button" value="Choose File"/> No file chosen <input type="button" value="Import"/> <input type="button" value="Delete"/>
Trusted CA2		<input type="button" value="Choose File"/> No file chosen <input type="button" value="Import"/> <input type="button" value="Delete"/>

**Local Certificate Setting**

Certificate days:

Certificate password (4 to 63 characters):

Organizational unit name (eg, section):

Certificate name:

Email address:

Name	Certificate Days	Certificate Password	Organizational Unit Name	Certificate Name	Email Address	Action
Local certificate 1						<input type="button" value="Certificate Export"/> <input type="button" value="PKCS#12 Export"/> <input type="button" value="Delete"/>
Local certificate 2						<input type="button" value="Certificate Export"/> <input type="button" value="PKCS#12 Export"/> <input type="button" value="Delete"/>
Local certificate 3						<input type="button" value="Certificate Export"/> <input type="button" value="PKCS#12 Export"/> <input type="button" value="Delete"/>
Local certificate 4						<input type="button" value="Certificate Export"/> <input type="button" value="PKCS#12 Export"/> <input type="button" value="Delete"/>
Local certificate 5						<input type="button" value="Certificate Export"/> <input type="button" value="PKCS#12 Export"/> <input type="button" value="Delete"/>

To generate a root CA certificate, complete the following steps:

1. In the **Certificate Generation** screen, enter information in the fields under **Root Certificate Generation**.

Field	Description
<b>Certificate days</b>	Enter the number of days the certificate is valid for.
<b>Certificate password</b>	Enter a password to create a password-protected certificate.
<b>Country name</b>	Enter the country.
<b>State or province name</b>	Enter the state or the province.
<b>Locality name</b>	Enter the city.
<b>Organization name</b>	Enter the name of the organization.
<b>Organization unit name</b>	Enter the unit or section in the organization.
<b>Common name</b>	Enter a name (such as a server name or your name).
<b>Email address</b>	Enter an email address.

2. Click **Generate Root CA**.

After you have generated the root CA certificate, generate a local certificate and export the key files. Complete the following steps:

1. In the **Certificate Generation** screen, enter information in the fields under **Local Certificate Settings**.

Field	Description
<b>Certificate days</b>	Enter the number of days the certificate is valid for.
<b>Certificate password</b>	Enter a password to create a password-protected certificate.
<b>Organization unit name</b>	Enter the unit or section in the organization.
<b>Common name</b>	Enter a name (such as a server name or your name).
<b>Email address</b>	Enter an email address.

2. Click **Generate Local Certificate**.
3. Click **Certificate Export** to export the public key file for the certificate that you can import on to a remote VPN gateway.
4. Click **PKCS#12 Export** to export the private key file for local certificates on the OnCell 3120-LTE-1. You can import the local certificate in the **Local Certificate Upload** screen.

### Local Certificate Upload

If you configure X.509 authentication mode for VPN tunnel setup, you must import a local certificate on the OnCell 3120-LTE-1.

You can add or delete a local certificate in the **Local Certificate Upload** screen.

**Local Certificate Upload**

PKCS#12 upload  No file chosen

Password

Name	Password	Subject	Action
			<input type="button" value="Delete"/>
			<input type="button" value="Delete"/>
			<input type="button" value="Delete"/>
			<input type="button" value="Delete"/>
			<input type="button" value="Delete"/>

1. Click **Advanced Settings > VPN > X.509 Certificate > Local Certificate Upload**.
2. In the **PKCS#12 upload** field, click **Choose File** to select a local certificate file
3. In the **Password** field, enter the certificate password.
4. Click **Import**.

**NOTE** You can generate a local certificate in the **Certificate Generation** screen.

### Remote Certificate Upload

You can add or delete a certificate from the remote VPN gateway in the **Remote Certificate Upload** screen.

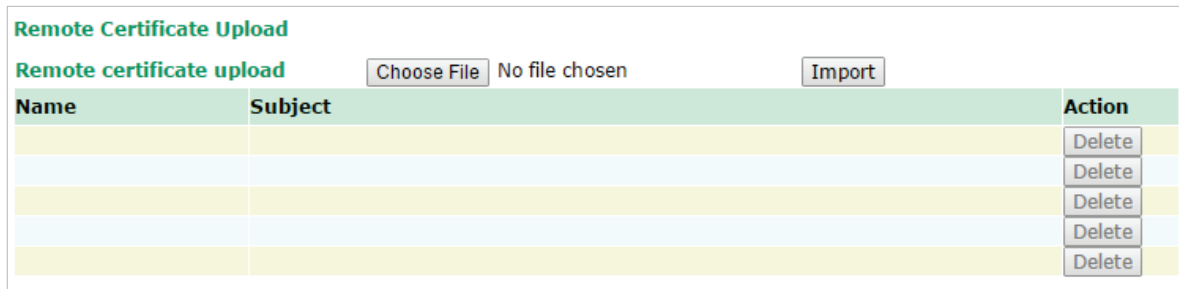

1. Click **Advanced Settings > VPN > X.509 Certificate > Remote Certificate Upload**.
2. In the **Remote certificate upload** field, click **Browse** to select a local certificate.
3. Click **Import**.

## OpenVPN

### Overview—OnCell 3120-LTE-1 OpenVPN Feature

The OnCell 3120-LTE-1 OpenVPN:

- Provides SSL/TLS (layer-4) security in a network with gateway-to-gateway topology. It can create either a layer-3 based IP tunnel (TUN), or a layer-2 based Ethernet (TAP) that can carry any type of Ethernet traffic.
- Supports both server and client mode communication through TCP/UDP to transfer encrypt data
- Provides server mode to push the network behind the OnCell 3120-LTE-1 to the server site so as to make end-to-end connection possible (Figure 1)
- Acts as an OpenVPN server to force gateway routing and redirect all external connections only through the VPN server’s gateway. (Figure2)
- Enables the OnCell 3120-LTE-1 to act as an OpenVPN server to allow duplicate OpenVPN clients access under the same account name. This also allows OpenVPN clients to communicate with each site. (Figure 3)

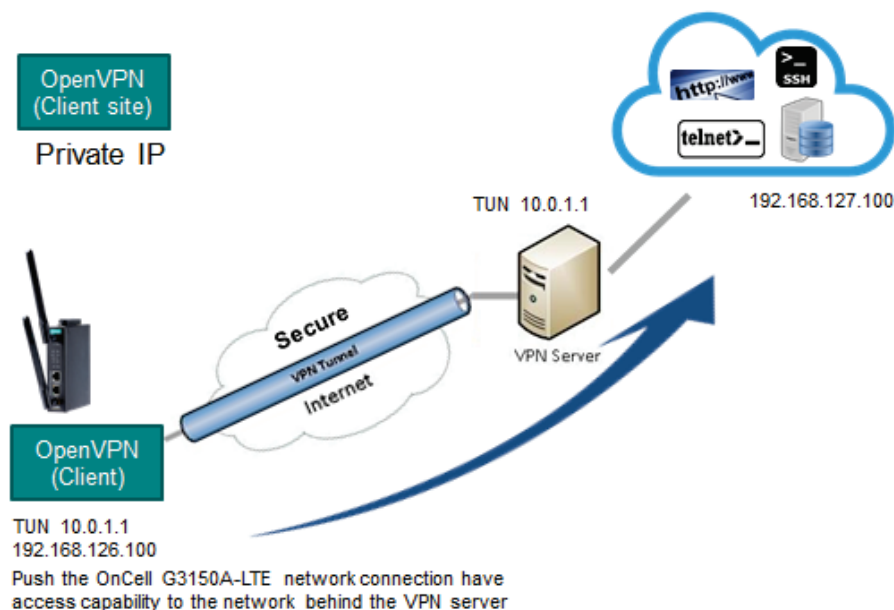

Figure 1: Push Network

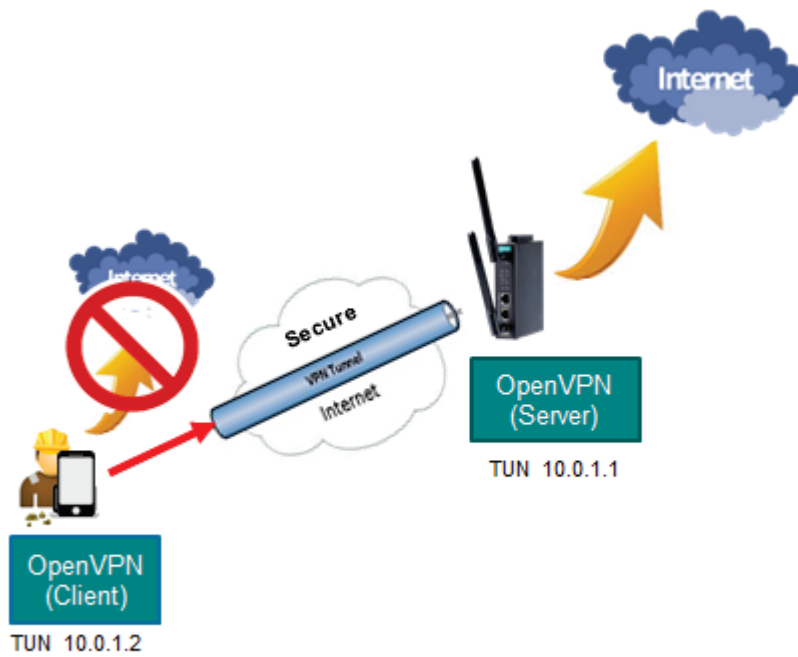

Figure 2: Redirect to Default Gateway

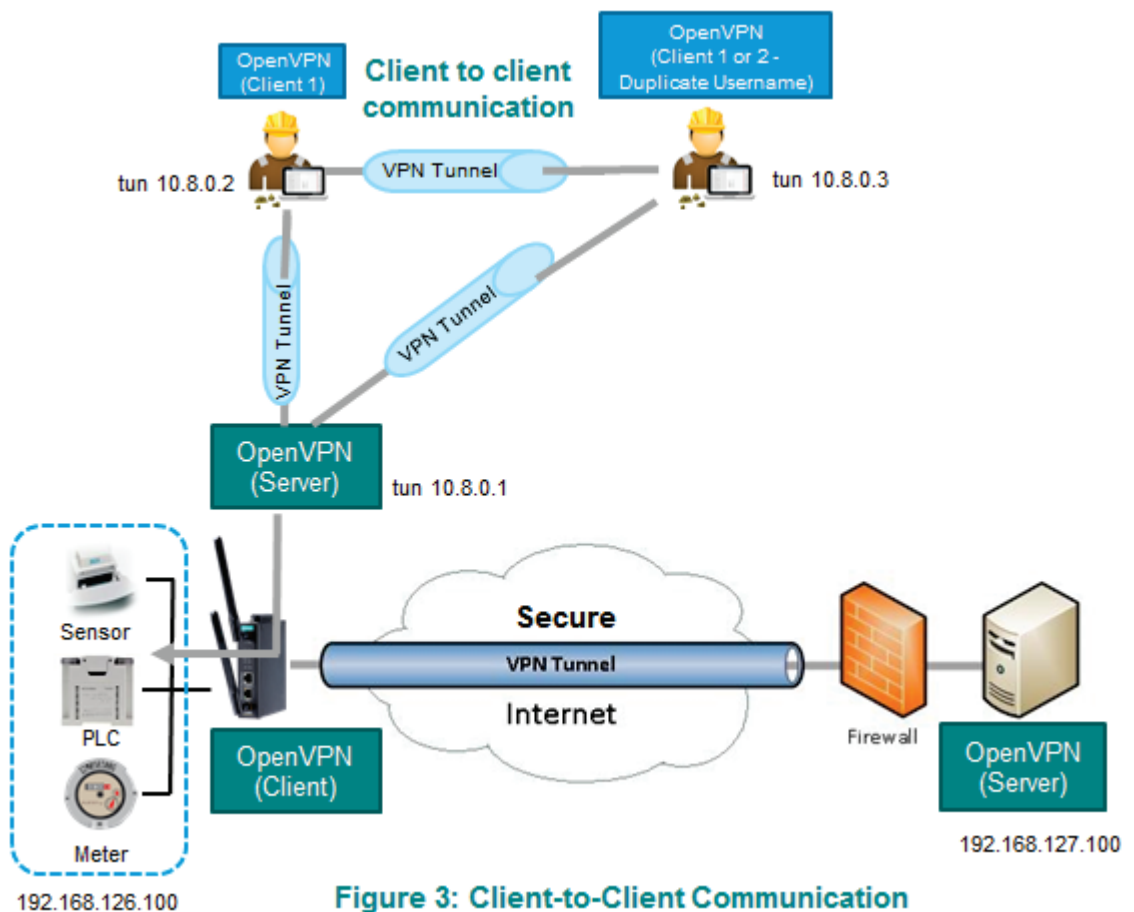
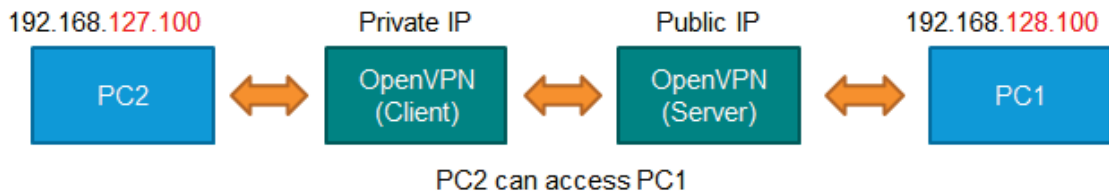

Figure 3: Client-to-Client Communication

**OpenVPN—Router Mode**

Use this OpenVPN mode to connect two sites that are under different subnets (in Layer 3) and encrypt the TCP/UDP package data transmission. Router mode cannot process broadcast or multicast frames.



### OpenVPN—Bridge Mode

Use this OpenVPN mode to have two sites under the same subnet (in Layer 2) and encrypt IP packages during data transmission.



## Server Settings

### Server Setting—TUN (Router Mode)

Server Setting	
OpenVPN	Enable ▾
Interface type	TUN (Router) ▾
Network IP	10.8.0.0
Netmask	255.255.255.0
Push network IP	192.168.127.0
Push netmask	255.255.255.0
Protocol	UDP ▾
Port number	1194
Encryption algorithm	BlowFish CBC ▾
Hash algorithm	SHA1 ▾
LZO compression	Enable ▾
User authentication	Password ▾
Keepalive	Enable ▾
Redirect to default gateway	Disable ▾
Client-to-client communication	Disable ▾
Allow duplicate user name	Disable ▾

Setting	Description	Factory Default
<b>OpenVPN</b>	Select Enable to activate the VPN tunnel.	Disable
<b>Interface Type</b>	Select OpenVPN tunnel connection by router mode or bridge mode	TUN (Router)
<b>Network IP</b>	This is the virtual network used for private communications between server and client hosts. The first network address will be assigned to the server virtual interface. The remaining network addresses can optionally be assigned to the connecting clients.	10.8.0.0
<b>Netmask</b>	Enter the subnet netmask of virtual network.	255.255.255.0
<b>Push network IP</b>	This is the network that will be accessible from the remote endpoint. You may leave this blank if you don't want to add a route to the local network through this tunnel on the remote machine. This is generally set to your LAN network.	192.168.127.0
<b>Push netmask</b>	Enter the netmask of the network behind the VPN server.	255.255.255.0
<b>Protocol</b>	Select the protocol to be used for VPN.	UDP
<b>Port number</b>	Enter the port number for TCP / UDP connection	1194
<b>Encryption algorithm</b>	Select authentication mode for key exchange. The configuration fields vary depending on the authentication mode you select.	BlowFish CBC
<b>Hash algorithm</b>	Select the MD5, SHA-1, SHA-256, or SHA-512 VPN key exchange phase 1 hash mode.	SHA1
<b>LZO compression</b>	Compress tunnel packets using the LZO algorithm	Enable
<b>User authentication</b>	Only password authentication is supported in server mode	N/A
<b>Keepalive</b>	Select <b>Enable</b> to check if the client connection is alive.	Disable
<b>Redirect to default gateway</b>	Select <b>Enable</b> to force all clients generated traffic to pass through the tunnel	Disable
<b>Client-to-client communication</b>	Select <b>Enable</b> to allow communication between clients connected to the server. Client-to-communication requires <b>Redirect to default gateway</b> to be enabled. If this function is disabled, the OnCell will only be able to communicate with the server (see Figure 3: Client-to-Client Communication above.)	Disable
<b>Allow duplicate user name</b>	Select <b>Enable</b> to allow multiple clients using the same common name. Note: There can only be one active session associated with a user name at any given time. If another client with the same common name connects, the previous client's session will be ended. This setting is not recommended but may be needed in some scenarios.	Disable



### Server Setting—TAP (Bridge Mode)

Server Setting	
OpenVPN	Disable ▾
Interface type	TAP (Bridge) ▾
DHCP Proxy	Enable ▾
External Gateway IP	192.168.127.254
External Gateway Netmask	255.255.255.0
IP Pool Start	192.168.127.1
IP Pool End	192.168.127.253
Protocol	UDP ▾
Port number	1194
Encryption algorithm	BlowFish CBC ▾
Hash algorithm	SHA1 ▾
LZO compression	Enable ▾
User authentication	Password ▾
Keepalive	Enable ▾
Client-to-client communication	Disable ▾
Allow duplicate user name	Disable ▾

Setting	Description	Factory Default
DHCP Proxy	Select <b>Disable</b> to activate the DHCP function.	Disable
External Gateway IP	Enter the remote site VPN server gateway IP address.	192.168.127.254
External Gateway Netmask	Enter the remote site VPN server subnet netmask.	255.255.255.0
IP Pool Start	This is the network that will access to remote VPN server and the IP range that can be assigned (clients number) in this local network. The IP address entered here will be the start IP for the local network (client).	192.168.127.1
IP Pool End	The IP address entered here will be the end point of the IP address for the local network (client).	192.168.127.253

**NOTE** The Bridge mode is the recommended mode for multicast and broadcast requirements.

### Server Certificate Upload

Client Certificate Upload		
Name	Subject	Action
Root CA		<input type="button" value="Choose File"/> No file chosen <input type="button" value="Import"/> <input type="button" value="Delete"/>

PKCS#12 upload			
Name	Password	Subject	Action
Server CA			<input type="button" value="Delete"/>

Setting	Description
Root CA	Browse your local drive and choose the certificate generated by X.509 then click import to import the certificate.
PKCS#12 Upload	Browse your local drive and choose the certificate with password which generated by X.509 then click import to import the certificate.
Password	Enter the password that you fill in X.509 password column.

Setting	Description
Server CA	The column shows the information of certification password and subject that imported.

### Server User Management

Enables management and export of user configurations.

**Server User Management**

Status	Username	Remote Network IP	Remote Netmask	Action
Disable				<input type="button" value="Edit"/> <input type="button" value="Delete"/>
Disable				<input type="button" value="Edit"/> <input type="button" value="Delete"/>
Disable				<input type="button" value="Edit"/> <input type="button" value="Delete"/>
Disable				<input type="button" value="Edit"/> <input type="button" value="Delete"/>
Disable				<input type="button" value="Edit"/> <input type="button" value="Delete"/>

**User Management Settings**

User Active

User name

Password

Confirm password

Remote Network

Remote Netmask

Setting	Description	Factory Default
<b>Edit</b>	Click <b>Edit</b> to open the <b>User Management Settings</b> window.	-
<b>User Active</b>	Select Enable to activate User accessibility	Disable
<b>User Name</b>	Enter User Name.	N/A
<b>Password</b>	Enter the password.	N/A
<b>Confirm Password</b>	Enter the password again. This must match the with the Password field.	N/A
<b>Remote Network</b>	Enter the IP address of the remote network the user is connecting from.	N/A
<b>Remote Netmask</b>	Enter the subnet mask of the remote network the user is connecting from.	N/A

### Server to User Config

Export the user configuration.

#### Server to User Config

#### User Configuration File Export

---

## Client Settings

**Client Setting**

Status	Interface Type	Remote Server	Protocol	Encryption Cipher	LZO Compression	Authentication Mode	Action
Disabled	TUN		tcp	BF-CBC	ENABLE	Password	<input type="button" value="Edit"/>

**Client Setting**

**Client enable**

**Interface type**

**Remote server IP**

**Protocol**

**Port number**

**Encryption algorithm**

**Hash algorithm**

**LZO compression**

**User authentication**

**User name**

**Password**

Setting	Description	Factory Default
<b>Client enable</b>	Select <b>Enable</b> to activate OpenVPN Client	Disable
<b>Interface type</b>	Select OpenVPN tunnel connection by router mode or bridge mode	TUN(Router)
<b>Remote server IP</b>	This is the virtual network used for private communications between this server and client hosts. The first network address will be assigned to the server virtual interface. The remaining network addresses can optionally be assigned to the connecting clients. The remote site must assign a server IP, public IP, or carrier private network that is accessible to the clients.	10.8.0.0
<b>Protocol</b>	Select the protocol to be used for VPN.	UDP
<b>Port number</b>	Enter the remote server port number for TCP / UDP connection	1194
<b>Encryption algorithm</b>	Select authentication mode for key exchange. The configuration fields vary depending on the authentication mode you select.	BlowFish CBC
<b>Hash algorithm</b>	Select the MD5 or SHA-1 VPN key exchange phase 1 hash mode.	SHA1
<b>LZO compression</b>	Compress tunnel packets using the LZO algorithm	Enable
<b>User authentication</b>	Select password or certification to protect the authentication choose either one	password
<b>User name</b>	Enter the user name for the client that you set on the server.	N/A
<b>Password</b>	Enter the client password that you set on the server (up to 15 characters.)	N/A

### Client Certificate Upload

**Client Certificate Upload**

Name	Subject	Action
Root CA		<input type="button" value="Choose File"/> No file chosen <input type="button" value="Import"/> <input type="button" value="Delete"/>

---

PKCS#12 upload  No file chosen

Password

Name	Password	Subject	Action
Client CA			<input type="button" value="Delete"/>

Setting	Description	Factory Default
<b>Root CA</b>	Browse your local drive or import a certificate code.	
<b>PKCS#12 Upload</b>	Browse your local drive or import a certificate code.	
<b>Password</b>	Default password "moxa"	moxa
<b>Client CA</b>	The column shows the client certification password and subject imported.	

**NOTE** Before using the OpenVPN function, run an NTP check on the device to ensure that it is synchronized with the local time for proper authentication to take place.

### X.509 Certificate

X.509 is a digital certificate method commonly used for OpenVPN authentication. You can generate a self-signed root CA or local certificate on the OnCell 3120-LTE-1 and import or export the certificate on a remote VPN gateway.

To display the **Certificate Generation** screen, click **Advanced Settings > VPN > OpenVPN > X.509 Certificate > Certificate Generation**.

**Certificate Generation**

**Root Certificate Generation**

Certificate validity:  (days)

Country name (2 letter code):

State or province name (full name):

Locality (E.g., City):

Organization (E.g., Company):

Organizational unit (E.g., Section):

Name (E.g., server FQDN or your name):

Email address:

Name	Subject	Action
Root CA		<input type="button" value="Delete"/>

---

**Certificate Generation**

Server:

Certificate validity:  (days)

Certificate password (4 to 63 characters):

Organizational unit (E.g., Section):

Email address:

Name	Subject	Action
Server CA		<input type="button" value="Delete"/> <input type="button" value="PKCS#12 Export"/>
Client CA		<input type="button" value="Delete"/> <input type="button" value="PKCS#12 Export"/>

To generate a root CA certificate, complete the following steps:

1. In the Certificate Generation screen, enter information in the fields under Root Certificate Generation.

Setting	Description
<b>Certificate validity</b>	Enter the number of days the certificate is valid for.

Setting	Description
Country name(2 letter code)	Enter the country.
State or province name(full name)	Enter the state or the province.
Locality (E.g., city)	Enter the city.
Organization(E.g., company)	Enter the name of the organization.
Organizational unit(E.g., section)	Enter the unit or section in the organization.
Name(E.g., server, FQDN or your name)	Enter a name (such as a server name or your name).
Email address	Enter an email address.

2. Click Generate Root CA.

After you have generated the root CA certificate, generate a local certificate and export the key files. In the Certificate Generation screen, enter information in the fields under Local Certificate Settings.

Setting	Description
Certificate Generation	Generate a certificate for Server or Client
Certificate validity	Enter the number of days the certificate is valid for.
Certificate Password (4 to 63 characters)	Enter a password to create a password-protected certificate.
Organizational unit (E.g., Section)	Enter the unit or section in the organization.
Email address	Enter an email address.

## Scheduling and Power Management

The OnCell 3120-LTE-1 is able to enter 2 levels of standby mode to reduce power consumption when the OnCell is idle. Sleep mode allows the OnCell’s CPU to enter power saving mode and effectively reduces the power consumption to less than 2 watts. While the cellular connection is still alive, the OnCell can be woken up from sleep by Remote SMS Control or by setting a regular schedule. Hibernate mode puts the OnCell into deeper sleep by shutting off all active components except for a heartbeat. You can only wake the OnCell from hibernation by using the schedule management function.

**Power Management**

**Power Saving Mode**

Disable  
 Sleep mode (You can wake up the system using Remote SMS Control or Schedule Management functions; Power consumption : 2 W)  
 Hibernate mode (You can wake up the system using the Schedule Management function; Power consumption : 40 mW)

**Schedule Management**

Cellular connection fully functional time Customization ▾

Sun  Mon  Tue  Wed  Thu  Fri  Sat

Enter power saving mode time  :  (HH:MM)

Leave power saving mode time  :  (HH:MM)

**Note: Upon boot up, there is a 15 minute waiting period before the OnCell is able to enter power saving mode.**

Setting	Description	Factory Default
Power Saving Mode	<ul style="list-style-type: none"> <li><b>Disable</b>—The OnCell device will not enter power saving mode.</li> <li><b>Sleep mode</b>—The OnCell device can enter and leave power saving mode using the remote SMS control or schedule management functions. The power consumption</li> </ul>	Disable

Setting	Description	Factory Default
	<p>in this mode is 2 W.</p> <p>Note: If you select this mode, enable <b>Enter sleep mode</b> and <b>Leave sleep mode</b> on the Remote SMS Control page.</p> <ul style="list-style-type: none"> <li>• <b>Hibernate mode</b>—The OnCell device can enter and leave power saving mode using the schedule management function. The power consumption in this mode is 40 mW.</li> </ul>	
<b>Cellular connection fully functional time</b>	<ul style="list-style-type: none"> <li>• <b>Hourly</b>—Sets the minute in every hour when the OnCell device will enter and leave the power saving mode. The time (MM) should be set for both <b>Enter power saving mode time</b> and <b>Leave power saving mode time</b>.</li> <li>• <b>Daily</b>—Sets the hour/minute every day when the OnCell device will enter and leave the power saving mode. The time (HH:MM) should be set for both <b>Enter power saving mode time</b> and <b>Leave power saving mode time</b>.</li> <li>• <b>Customization</b>—Sets the day(s) of the week and the hour/minute of the selected day(s) when the OnCell device will enter and leave the power saving mode. The time (HH:MM) should be set for both <b>Enter power saving mode time</b> and <b>Leave power saving mode time</b>. Note that only one time can be set for each day of the week.</li> </ul>	Customization

## Serial Port Settings

### Serial Operation Mode

In this section, we describe the various operation modes of the OnCell 3120-LTE-1. The OnCell 3120-LTE-1 modes are grouped by type of application, such as Device Control. The options include an operation mode that relies on a driver installed on the host computer, and operation modes that rely on TCP/IP socket programming concepts.

The OnCell 3120-LTE-1 can enable cellular network-in a serial device. OnCell 3120-LTE-1 device is assigned an IP address by the Internet service provider (ISP). In addition, the OnCell 3120-LTE-1 can enable cellular connectivity in Ethernet devices on the local Ethernet. See the *OnCell Central Manager user's manual* for details.

The OnCell 3120-LTE-1 enables traditional serial (RS-232/422/485) devices for transmitting data over the cellular network. The IP gateway can bi-directionally translate data between the serial and IP formats. With the OnCell 3120-LTE-1, your computer will be able to access, manage, and configure remote facilities and

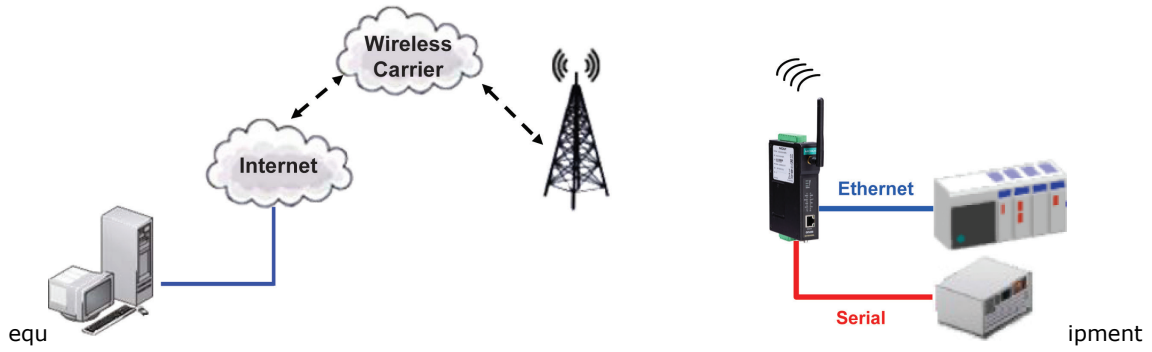

equ  
over the cellular network from anywhere in the world.

Traditional SCADA and data collection systems rely on serial ports to collect data from various kinds of instruments. Since the OnCell 3120-LTE-1 network-enables instruments equipped with an RS-232, RS-422, or RS-485 communication port, your SCADA and data collection systems will be able to access all instruments connected to a standard TCP/IP network, regardless of whether the devices are used locally or at a remote site.

The OnCell 3120-LTE-1 is an external IP-based network device that allows you to expand a serial port for a host computer on demand. As long as your host computer supports the TCP/IP protocol, you will not be limited by the host computer’s bus limitation (such as ISA or PCI), nor will you be limited if you do not have drivers for various operating systems.

In addition to providing socket access, the OnCell 3120-LTE-1 also comes with a Real COM driver and a Reverse Real COM driver that transmits all serial signals intact. This enables you to preserve your existing COM-based software without needing to invest in additional software.

Three different socket modes are available: TCP Server, TCP Client, and UDP. The main difference between the TCP and UDP protocols is that TCP guarantees delivery of data by requiring the recipient to send an acknowledgement to the sender. UDP does not require this type of verification, making it possible to offer faster delivery. UDP also allows you to unicast data to one IP, or multicast the data to a group of IP addresses.

The serial port of the OnCell 3120-LTE-1 can be configured to different operation modes for different applications. After selecting the application and mode, click **Add** and the selected mode will be shown in the “Overview” below.

You can click on **Edit** to continue with the detailed configuration of the selected operation mode, or click on **Remove** to disable the serial port.

Operation Mode

Interface: Serial 1

Application: Device Control

Mode: Real COM

Add

Overview

Port	Application	Mode	Action
Serial 1	Device Control	Real COM	Edit Remove

### Device Control Applications

The OnCell 3120-LTE-1 offers the following modes for device control applications: Real COM, Reverse Real COM, and RFC2217 modes.

## Real COM Mode

**NOTE** You can download the Moxa Drivers for operation modes from [www.moxa.com](http://www.moxa.com).  
File Name: Windows Driver Manager

In Real COM mode, the bundled drivers are able to establish a transparent connection between a host and a serial device by mapping the serial port on the OnCell 3120-LTE-1 to a local COM port on the host computer. Real COM mode supports up to 2 simultaneous connections that enable 2 hosts to simultaneously collect data from the same serial device.

One of the major conveniences of using Real COM mode is that it allows you to use software that was written for pure serial communication applications. The OnCell COM driver intercepts data sent to the host's COM port, packs it into a TCP/IP packet, and then redirects it through the host's Ethernet card to the Internet. At the other end of the connection, the OnCell 3120-LTE-1 accepts the IP frame from the cellular network, unpacks the TCP/IP packet, and then transparently sends the data through the serial port to the attached serial device.

**NOTE** In order to avoid a TCP port conflict with other applications, please aware of that data port used on the driver is 950 and the command port is 966.

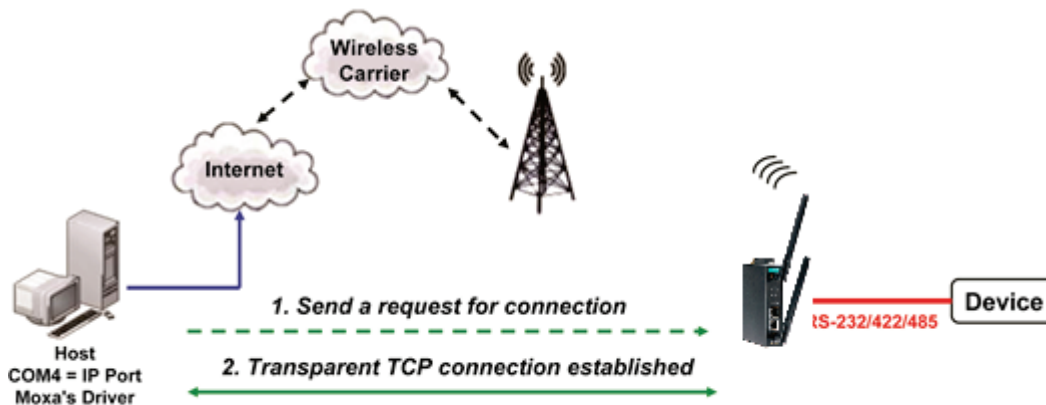

### Operation Modes

Information	
Interface	Serial port 1
Application	Device Control
Mode	Real COM
Connection Settings	
Secure connection	<input type="radio"/> Enable <input checked="" type="radio"/> Disable
Max number of connections	<input type="text" value="1"/>
TCP alive check interval	<input type="text" value="7"/> (0 to 99 minutes)
When a connection is down	Set RTS signal to <input type="radio"/> Low <input checked="" type="radio"/> High
	Set DTR signal to <input type="radio"/> Low <input checked="" type="radio"/> High
Data Packing Settings	
Packet length	<input type="text" value="0"/> (0 to 1024 bytes)
Delimiter 1	<input type="checkbox"/> Enable <input type="text" value="00"/> (2 hexadecimal digits. E.g., 0A)
Delimiter 2	<input type="checkbox"/> Enable <input type="text" value="00"/> (2 hexadecimal digits. E.g., 0A)
Delimiter process	<input type="text" value="Delimiter"/> (Processed only if Packet length is 0)
Force transmit interval	<input type="text" value="0"/> (0 to 65535 ms)
<input type="button" value="Submit"/>	



Setting	Description	Factory Default
<b>Secure connection</b>	If you select Enable, data sent through the Ethernet will be encrypted with SSL.	Disable
<b>Max number of connections</b>	This field is used if you need to receive data from different hosts simultaneously. When set to 1, only one specific host can access this port of the OnCell 3120-LTE-1, and the OnCell COM driver on that host will have full control over the port. When set to 2, the specified number of hosts' OnCell COM driver may open this port at the same time. When multiple hosts on the OnCell COM driver open the port at the same time, the COM driver only provides a pure data tunnel --no control ability unless "Allow Driver Control" is enabled. The serial port parameters will use firmware settings instead of depending on your application program (AP). Application software that is based on the COM driver will receive a driver response of "success" when the software uses any of the Win32 API functions. The firmware will only send data back to the driver on the host. Data will be sent first-in-first-out when data comes into the OnCell 3120-LTE-1 from the Cellular or Ethernet interface.	1



### ATTENTION

When Max connection is greater than 1, the OnCell 3120-LTE-1 will use a multi-connection application (i.e., 2 hosts are allowed access to the port at the same time). When using a multi-connection application, the OnCell 3120-LTE-1 will use the serial communication parameters as defined here in the web console, and all hosts connected to the port must use identical serial settings. If one of the hosts opens the COM port with different serial settings, data will not be transmitted properly.

Setting	Description	Factory Default
<b>TCP alive check interval</b>	This field specifies how long the OnCell 3120-LTE-1 will wait for a response to "keep alive" packets before closing the TCP connection. The OnCell 3120-LTE-1 checks the connection status by sending periodic "keep alive" packets. If the remote host does not respond to the packet within the time specified in this field, the OnCell 3120-LTE-1 will force the existing TCP connection to close. For socket and device control modes, the OnCell 3120-LTE-1 will listen for another TCP connection from another host after closing the connection. If <b>TCP alive check time</b> is set to <b>0</b> , the TCP connection will remain open and will not send any "keep alive" packets.	7 min
<b>When a connection is down</b>	You can configure what happens to the RTS and DTR signals when the Cellular or Ethernet connection goes down. For some applications, serial devices need to know the Cellular or Ethernet link status through RTS or DTR signals sent through the serial port. Use "low" if you want the RTS and DTR signal to change their state to low when the Cellular or Ethernet connection gets disconnected. Use "always high" if you do not want the cellular or Ethernet connection status to affect the RTS or DTR signals.	Always High
<b>Packing length</b>	The <b>Packing length</b> setting refers to the maximum amount of data that is allowed to accumulate in the serial port buffer before sending. At the default of 0 for packet length, no maximum amount is specified and data in the buffer will be	0

Setting	Description	Factory Default
	sent as specified by the delimiter settings or when the buffer is full. When a packet length between 1 and 1024 bytes is specified, data in the buffer will be sent as soon it reaches the specified length.	
<b>Delimiter 1</b> <b>Delimiter 2</b>	When <b>Delimiter 1</b> is enabled, the serial port will queue the data in the buffer and send the data to the Cellular or Ethernet port when a specific character, entered in hex format, is received. A second delimiter character may be enabled and specified in the <b>Delimiter 2</b> field, so that both characters act as the delimiter to control when data should be sent.	00

**ATTENTION**

In order to enable a delimiter, packet length must be set to 0. **Delimiter 2** should only be enabled in conjunction with **Delimiter 1** and never on its own; otherwise there may be data errors. Even when a delimiter is enabled, the OnCell 3120-LTE-1 will still pack and send the data when the amount of data exceeds 1 KB.

Setting	Description	Factory Default
<b>Delimiter process</b>	<p>The Delimiter process field determines how the data is handled when a delimiter is received. <b>Delimiter 1</b> must be enabled for this field to have effect. If Delimiters 1 and 2 are both enabled, both characters must be received for the delimiter process to take place.</p> <ul style="list-style-type: none"> <li>• <b>Delimiter:</b> Data in the buffer will be transmitted when the delimiter is received.</li> <li>• <b>Delimiter + 1:</b> Data in the buffer will be transmitted after 1 additional byte is received following the delimiter.</li> <li>• <b>Delimiter + 2:</b> Data in the buffer will be transmitted after 2 additional bytes are received following the delimiter.</li> <li>• <b>Strip Delimiter:</b> Data in the buffer is first stripped of the delimiter before being transmitted.</li> </ul>	Delimiter
<b>Force transmit</b>	<p>This parameter defines how large a gap in serial communication the OnCell 3120-LTE-1 will allow before packing the serial data in its internal buffer for network transmission.</p> <p>As data is received through the serial port, it is stored by the OnCell 3120-LTE-1 in the internal buffer. The OnCell 3120-LTE-1 transmits the data stored in the buffer via TCP/IP when the internal buffer is full or as specified by the force-transmit time.</p> <p>When this field is set to 0, the force transmit time is disabled and transmission is determined solely by the data in the internal buffer. When the force transmit time is set to a value from 1 to 65535, the TCP/IP protocol software will pack the serial data received for transmission after the gap in serial communication exceeds the specified force transmit time. The optimal force-transmit time setting depends on your application. However, it must be set to a value that is more than one-character interval within the specified baudrate. For example, assume that the serial port is set to 1200 bps, 8 data bits, 1 stop bit, and no parity. In this case, the total</p>	0 ms

Setting	Description	Factory Default
	<p>number of bits needed to send a character is 10 bits, and the time required to transfer one character is <b>(10 (bits) / 1200 (bits/s)) × 1000 (ms/s) = 8.3 ms</b>. Therefore, you should set the force transmit time to be greater than 8.3 ms, so in this case, it must be greater than or equal to 10 ms.</p> <p>If it is necessary to send a series of characters in the same packet, the serial device will need to send that series of characters within the specified force transmit time, and the total length of data must be less than or equal to the OnCell 3120-LTE-1's internal buffer size (1 KB per port).</p>	

## Types of Real COM Connection

This section illustrates the types of Real COM connections you can use, depending on the service you obtain from your local cellular service provider.

### Fixed Public IP for OnCell

If your cellular service provider offers a fixed public IP address after you connect to the cellular network, you can access the OnCell 3120-LTE-1 via a host PC using either a private IP or public IP.

#### Real COM mode

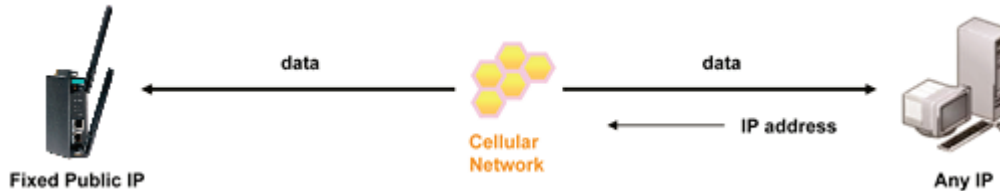

### Utilize Auto IP report

If your cellular service provider offers a dynamic public IP address after you connect to the cellular network, you can access the OnCell 3120-LTE-1 via a host PC using a fixed public IP. Since the IP address of the OnCell 3120-LTE-1 is changed each time it is connected to the cellular network, the host IP can be notified of the change by an Auto IP Report message sent from the OnCell 3120-LTE-1. Please refer to *Auto IP Report Settings* to see the format of the Auto IP Report Protocol.

#### Real COM mode & Auto IP Report enabled

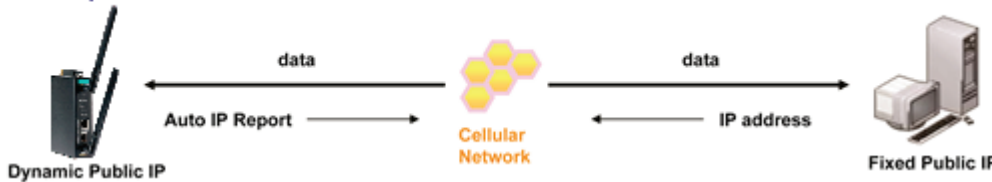

### Domain name with DDNS

If your cellular service provider offers a public IP address after you connect to the cellular network, you can also access the OnCell 3120-LTE-1 using the domain name. To do this, you will need to register with a DDNS service provider and then enable the DDNS function in the OnCell 3120-LTE-1. Please refer to Appendix B for more information.

#### Real COM mode & DDNS enabled

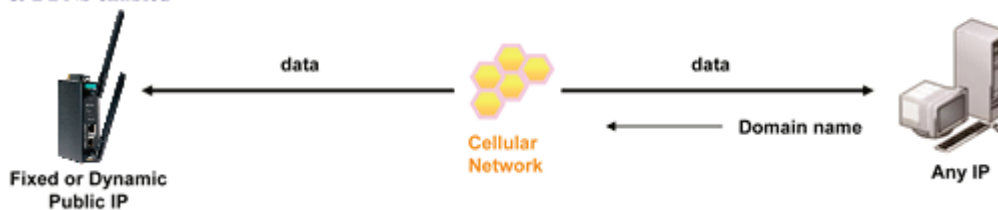

## RFC 2217 Mode

RFC-2217 mode is similar to Real COM mode in that a driver is used to establish a transparent connection between a host computer and a serial device by mapping the serial port on the OnCell 3120-LTE-1 to a local COM port on the host computer. RFC2217 defines general COM port control options based on the Telnet protocol. Third party drivers supporting RFC-2217 are widely available on the Internet and can be used to implement virtual COM mapping to your OnCell 3120-LTE-1's serial port.

<b>Information</b>	
<b>Interface</b>	Serial port 1
<b>Application</b>	Device Control
<b>Mode</b>	RFC2217
<b>Connection Settings</b>	
<b>Secure connection</b>	<input type="radio"/> Enable <input checked="" type="radio"/> Disable
<b>TCP port</b>	<input type="text" value="4001"/>
<b>TCP alive check interval</b>	<input type="text" value="7"/> (0 to 99 minutes)
<b>Data Packing Settings</b>	
<b>Packet length</b>	<input type="text" value="0"/> (0 to 1024 bytes)
<b>Delimiter 1</b>	<input type="checkbox"/> Enable <input type="text" value="00"/> (2 hexadecimal digits. E.g., 0A)
<b>Delimiter 2</b>	<input type="checkbox"/> Enable <input type="text" value="00"/> (2 hexadecimal digits. E.g., 0A)
<b>Delimiter process</b>	Delimiter <input type="text" value=""/> (Processed only if Packet length is 0)
<b>Force transmit interval</b>	<input type="text" value="0"/> (0 to 65535 ms)
<input type="button" value="Submit"/>	

Setting	Description	Factory Default
<b>Secure connection</b>	If you select Enable, data sent through the Ethernet will be encrypted with SSL.	Disable
<b>TCP port</b>	This is the TCP port number assignment for the serial port on the OnCell 3120-LTE-1. It is the port number that the serial port uses to listen to connections, and that other devices must use to contact the serial port. To avoid conflicts with well-known TCP ports, the default is set to 4001.	4001
<b>TCP alive check interval</b>	This field specifies how long the OnCell 3120-LTE-1 will wait for a response to "keep alive" packets before closing the TCP connection. The OnCell 3120-LTE-1 checks connection status by sending periodic "keep alive" packets. If the remote host does not respond to the packet within the time specified in this field, the OnCell 3120-LTE-1 will force the existing TCP connection to close. For socket and device control modes, the OnCell 3120-LTE-1 will listen for another TCP connection from another host after closing the connection. If <b>TCP alive check time</b> is set to <b>0</b> , the TCP connection will remain open and will not send any "keep alive" packets.	7 min
<b>Packing length</b>	The <b>Packing length</b> setting refers to the maximum amount of data that is allowed to accumulate in the serial port buffer before sending. At the default of 0 for packet length, no maximum amount is specified and data in the buffer will be sent as specified by the delimiter settings or when the buffer is full. When a packet length between 1 and 1024 bytes is specified, data in the buffer will be sent as soon it reaches the specified length.	0

Setting	Description	Factory Default
<b>Delimiter 1</b> <b>Delimiter 2</b>	When <b>Delimiter 1</b> is enabled, the serial port will queue the data in the buffer and send the data to the Cellular or Ethernet port when a specific character, entered in hex format, is received. A second delimiter character may be enabled and specified in the <b>Delimiter 2</b> field, so that both characters act as the delimiter to control when data should be sent.	Disabled



**ATTENTION**

In order to enable a delimiter, the packet length must be set to 0. **Delimiter 2** should only be enabled in conjunction with **Delimiter 1** and never on its own to avoid data errors. Even when a delimiter is enabled, the OnCell 3120-LTE-1 will still pack and send the data when the amount of data exceeds 1 KB.

Setting	Description	Factory Default
<b>Delimiter process</b>	<p>The Delimiter process field determines how the data is handled when a delimiter is received. <b>Delimiter 1</b> must be enabled for this field to have effect. If Delimiters 1 and 2 are both enabled, both characters must be received for the delimiter process to take place.</p> <ul style="list-style-type: none"> <li>• <b>Delimiter:</b> Data in the buffer will be transmitted when the delimiter is received.</li> <li>• <b>Delimiter + 1:</b> Data in the buffer will be transmitted after 1 additional byte is received following the delimiter.</li> <li>• <b>Delimiter + 2:</b> Data in the buffer will be transmitted after 2 additional bytes are received following the delimiter.</li> <li>• <b>Strip Delimiter:</b> Data in the buffer is first stripped of the delimiter before being transmitted.</li> </ul>	Delimiter
<b>Force transmit</b>	<p>This parameter defines how large a gap in serial communication the OnCell 3120-LTE-1 will allow before packing the serial data in its internal buffer for network transmission.</p> <p>As data is received through the serial port, it is stored by the OnCell 3120-LTE-1 in the internal buffer. The OnCell 3120-LTE-1 transmits the data stored in the buffer via TCP/IP when the internal buffer is full or as specified by the force-transmit time.</p> <p>When this field is set to 0, the force transmit time is disabled and transmission is determined solely by the data in the internal buffer. When the force transmit time is set to a value from 1 to 65535, the TCP/IP protocol software will pack the serial data received for transmission after the gap in serial communication exceeds the specified force transmit time. The optimal force-transmit time setting depends on your application. However, it must be set to a value that is more than one-character interval within the specified baudrate. For example, assume that the serial port is set to 1200 bps, 8 data bits, 1 stop bit, and no parity. In this case, the total number of bits needed to send a character is 10 bits, and the time required to transfer one character is <b>(10 (bits) / 1200 (bits/s)) × 1000 (ms/s) = 8.3 ms</b>. Therefore, you should</p>	0 ms

Setting	Description	Factory Default
	<p>set the force transmit time to be greater than 8.3 ms, so in this case, it must be greater than or equal to 10 ms.</p> <p>If it is necessary to send a series of characters in the same packet, the serial device will need to send that series of characters within the specified force transmit time, and the total length of data must be less than or equal to the OnCell 3120-LTE-1's internal buffer size (1 KB per port).</p>	

## Reverse Real COM Mode

**NOTE** You can download the Moxa Drivers for operation modes from [www.moxa.com](http://www.moxa.com).  
File Name: Windows Driver Manager

Reverse Real COM mode uses a mechanism similar to port mapping to enable your remote device that is using a private IP address to remain accessible to external hosts. When this mode is enabled, the Moxa driver that comes with the device establishes a transparent connection from the device to the remote host by mapping the device's serial port to a local COM port on the remote host. Reverse Real COM mode supports up to 2 simultaneous connections that enable serial devices to send data to 2 hosts simultaneously.

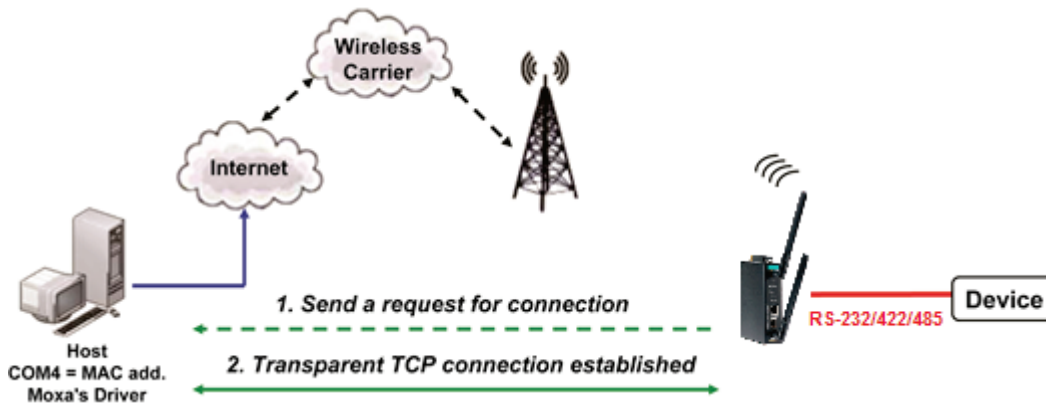

Operation Modes

<b>Information</b>	
Interface	Serial port 1
Application	Device Control
Mode	Reverse Real COM
<b>Connection Settings</b>	
Secure connection	<input type="radio"/> Enable <input checked="" type="radio"/> Disable
Destination address 1	<input type="text"/>
Destination data port 1	<input type="text" value="60950"/> (TCP port)
Destination cmd port 1	<input type="text" value="60966"/> (TCP port)
Designated local data port 1	<input type="text" value="0"/> (TCP port)
Designated local cmd port 1	<input type="text" value="0"/> (TCP port)
Destination address 2	<input type="text"/>
Destination data port 2	<input type="text" value="60950"/> (TCP port)
Destination cmd port 2	<input type="text" value="60966"/> (TCP port)
Designated local data port 2	<input type="text" value="0"/> (TCP port)
Designated local cmd port 2	<input type="text" value="0"/> (TCP port)
TCP alive check interval	<input type="text" value="7"/> (0 to 99 minutes)
When a connection is down	Set RTS signal to <input type="radio"/> Low <input checked="" type="radio"/> High Set DTR signal to <input type="radio"/> Low <input checked="" type="radio"/> High
<b>Data Packing Settings</b>	
Packet length	<input type="text" value="0"/> (0 to 1024 bytes)
Delimiter 1	<input type="checkbox"/> Enable <input type="text" value="00"/> (2 hexadecimal digits. E.g., 0A)
Delimiter 2	<input type="checkbox"/> Enable <input type="text" value="00"/> (2 hexadecimal digits. E.g., 0A)
Delimiter process	Delimiter <input type="text" value=""/> (Processed only if Packet length is 0)
Force transmit interval	<input type="text" value="0"/> (0 to 65535 ms)
<input type="button" value="Submit"/>	

Setting	Description	Factory Default
<b>Secure connection</b>	If you select Enable, data sent through the Ethernet will be encrypted with SSL.	Disable
<b>Destination address 1 through 2</b>	Specifying an IP address allows the OnCell 3120-LTE-1 to connect actively to the remote host. At least one destination must be provided.	None
<b>Destination data port</b>	This is the TCP port number assignment for the remote host/server. It is the port number that the OnCell 3120-LTE-1's serial port uses to establish connections with a remote host/server. To avoid conflicts with well-known TCP ports, the default is set to 60950.	60950
<b>Destination cmd port</b>	The Command port is the COM port for listening to SSDK commands from the host. In order to prevent a COM port conflict with other applications, the user can set the Command port to another port if needed.	60966



**ATTENTION**

Up to 2 connections can be established between OnCell 3120-LTE-1 hosts. Port 60950 might be blocked by a firewall. You should make sure the port is NOT blocked before you start using it.



**ATTENTION**

The destination IP address parameter can be the IP address or domain name.

Setting	Description	Factory Default
<b>Designated local port 1 through 2</b>	Use these fields to specify the designated local ports. (Example: 7010 through 7320)	0



Setting	Description	Factory Default
<b>TCP alive check interval</b>	This field specifies how long the OnCell 3120-LTE-1 will wait for a response to "keep alive" packets before closing the TCP connection. The OnCell 3120-LTE-1 checks connection status by sending periodic "keep alive" packets. If the remote host does not respond to the packet within the time specified in this field, the OnCell 3120-LTE-1 will force the existing TCP connection to close. For socket and device control modes, the OnCell 3120-LTE-1 will listen for another TCP connection from another host after closing the connection. If <b>TCP alive check time</b> is set to <b>0</b> , the TCP connection will remain open and will not send any "keep alive" packets.	7 min
<b>When a connection is down</b>	You can configure what happens to the RTS and DTR signals when the Cellular or Ethernet connection goes down. For some applications, serial devices need to know the Cellular or Ethernet link status through RTS or DTR signals sent through the serial port. Use "low" if you want the RTS and DTR signal to change their state to low when the Cellular or Ethernet connection gets disconnected. Use "always high" if you do not want the cellular or Ethernet connection status to affect the RTS or DTR signals.	Always high
<b>Packet length</b>	The Packet length setting refers to the maximum amount of data that is allowed to accumulate in the serial port buffer before sending. At the default of 0 for packet length, no maximum amount is specified and data in the buffer will be sent as specified by the delimiter settings or when the buffer is full. When a packet length between 1 and 1024 bytes is specified, data in the buffer will be sent as soon it reaches the specified length.	0
<b>Delimiter 1 Delimiter 2</b>	When <b>Delimiter 1</b> is enabled, the serial port will queue the data in the buffer and send the data to the Cellular or Ethernet port when a specific character, entered in hex format, is received.  A second delimiter character may be enabled and specified in the <b>Delimiter 2</b> field, so that both characters act as the delimiter to control when data should be sent.	Disabled



### ATTENTION

In order to enable a delimiter, packet length must be set to 0. **Delimiter 2** should only be enabled in conjunction with **Delimiter 1** and never on its own to avoid data errors. Even when a delimiter is enabled, the OnCell 3120-LTE-1 will still pack and send the data when the amount of data exceeds 1 KB.

Setting	Description	Factory Default
<b>Delimiter process</b>	The Delimiter process field determines how the data is handled when a delimiter is received. <b>Delimiter 1</b> must be enabled for this field to have effect. If Delimiters 1 and 2 are both enabled, both characters must be received for the delimiter process to take place. <ul style="list-style-type: none"> <li>• Delimiter: Data in the buffer will be transmitted when the delimiter is received.</li> <li>• Delimiter + 1: Data in the buffer will be transmitted after 1 additional byte is received following the delimiter.</li> <li>• Delimiter + 2: Data in the buffer will be transmitted after 2 additional bytes are received following the delimiter.</li> </ul>	Delimiter

Setting	Description	Factory Default
	<ul style="list-style-type: none"> <li>Strip Delimiter: Data in the buffer is first stripped of the delimiter before being transmitted.</li> </ul>	
<b>Force transmit</b>	<p>This parameter defines how large a gap in serial communication the OnCell 3120-LTE-1 will allow before packing the serial data in its internal buffer for network transmission.</p> <p>As data is received through the serial port, it is stored by the OnCell 3120-LTE-1 in the internal buffer. The OnCell 3120-LTE-1 transmits the data stored in the buffer via TCP/IP when the internal buffer is full or as specified by the force-transmit time.</p> <p>When this field is set to 0, the force transmit time is disabled and transmission is determined solely by the data in the internal buffer. When the force transmit time is set to a value from 1 to 65535, the TCP/IP protocol software will pack the serial data received for transmission after the gap in serial communication exceeds the specified force transmit time. The optimal force-transmit time setting depends on your application. However, it must be set to a value that is more than one-character interval within the specified baudrate. For example, assume that the serial port is set to 1200 bps, 8 data bits, 1 stop bit, and no parity. In this case, the total number of bits needed to send a character is 10 bits, and the time required to transfer one character is <b>(10 (bits) / 1200 (bits/s)) × 1000 (ms/s) = 8.3 ms</b>. Therefore, you should set the force transmit time to be greater than 8.3 ms, so in this case, it must be greater than or equal to 10 ms.</p> <p>If it is necessary to send a series of characters in the same packet, the serial device will need to send that series of characters within the specified force transmit time, and the total length of data must be less than or equal to the OnCell 3120-LTE-1's internal buffer size (1 KB per port).</p>	0 ms

## Types of Reverse Real COM Connection

### Reverse Real COM to PC's IP address

Most cellular service providers only provide customers with a dynamic private IP address, which means that the OnCell 3120-LTE-1 will only obtain an IP address once it is connected to the cellular network. Reverse Real COM is a great feature that allows a PC host to access an OnCell 3120-LTE-1 configured with private IP address.

#### Reverse Real COM mode

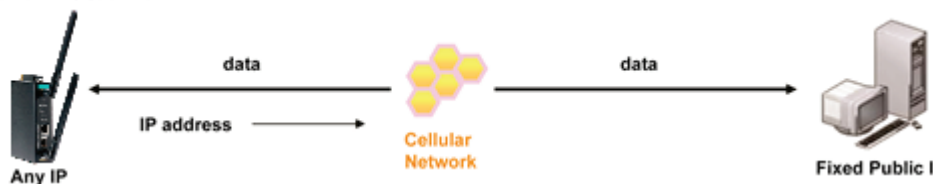

### Reverse Real COM to PC's domain name

With Reverse Real COM mode, you can connect to a PC host using the PC's IP address. You can also connect to your PC host with the PC's domain name, if you have one. Please refer to Appendix B for more information.

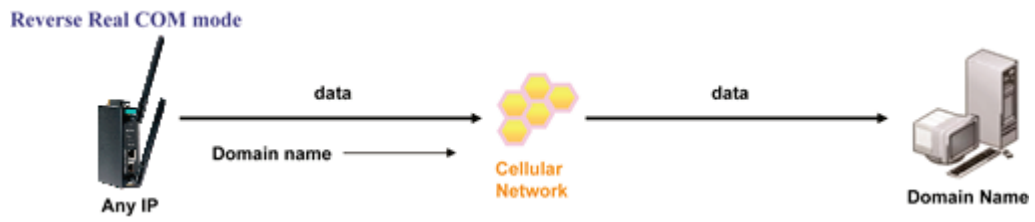

# Socket Applications

The OnCell 3120-LTE-1 offers the following modes for socket applications: TCP Server, TCP Client, and UDP.

## TCP Server Modes

In TCP Server mode, the serial port on the OnCell 3120-LTE-1 is assigned a port number. The host computer initiates contact with the OnCell 3120-LTE-1, establishes the connection, and receives data from the serial device. This operation mode also supports up to 2 simultaneous connections, enabling multiple hosts to collect data from the same serial device at the same time.

As illustrated in the figure, data transmission proceeds as follows: The host requests a connection from the OnCell 3120-LTE-1, which is configured for TCP Server mode. Once the connection is established, data can be transmitted in both directions between the host and the OnCell 3120-LTE-1.

### TCP Server mode includes optional data encryption using SSL

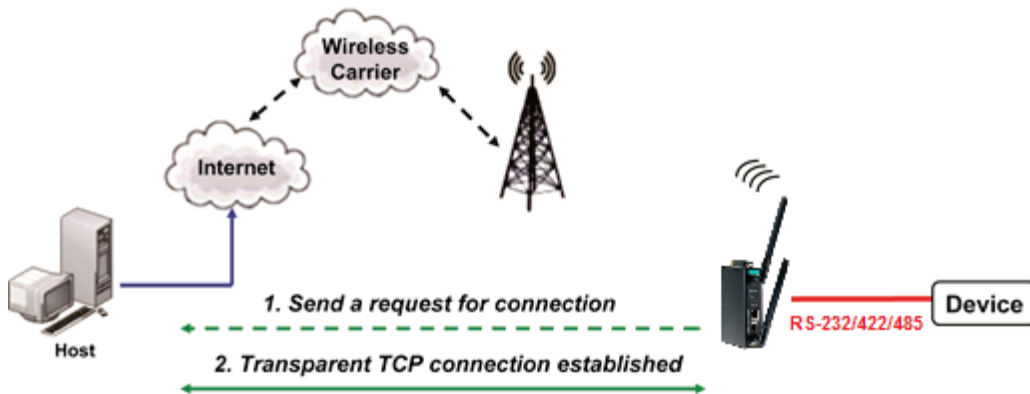

### Operation Modes

Information	
Interface	Serial port 1
Application Mode	Socket TCP Server
Connection Settings	
Secure connection	<input type="radio"/> Enable <input checked="" type="radio"/> Disable
Data port	<input type="text" value="4001"/> (TCP port)
Cmd port	<input type="text" value="966"/> (TCP port)
Max number of connections	<input type="text" value="1"/>
Inactivity time	<input type="text" value="0"/> (0 to 65535 ms)
TCP alive check interval	<input type="text" value="7"/> (0 to 99 minutes)
When a connection is down	RTS <input type="radio"/> Always low <input checked="" type="radio"/> Always high DTR <input type="radio"/> Always low <input checked="" type="radio"/> Always high
Data Packing Settings	
Packet length	<input type="text" value="0"/> (0 to 1024 bytes)
Delimiter 1	<input type="checkbox"/> Enable <input type="text" value="00"/> (2 hexadecimal digits. E.g., 0A)
Delimiter 2	<input type="checkbox"/> Enable <input type="text" value="00"/> (2 hexadecimal digits. E.g., 0A)
Delimiter process	Delimiter <input type="text" value=""/> (Processed only if Packet length is 0)
Force transmit interval	<input type="text" value="0"/> (0 to 65535 ms)
<input type="button" value="Submit"/>	

Setting	Description	Factory Default
<b>Secure connection</b>	If you select Enable, data sent through the Ethernet will be encrypted with SSL.	Disable
<b>Data port</b>	This is the TCP port number assignment for the serial port on the OnCell 3120-LTE-1. It is the port number that the serial port uses to listen to connections, and that other devices must use to contact the serial port. To avoid conflicts with well-known TCP ports, the default is set to 4001.	4001
<b>Cmd port</b>	The Command port is the TCP port for listening to SSDK commands from the host. In order to prevent a TCP port conflict with other applications, the user can set the Command port to another port if needed.	966
<b>Max number of connections</b>	This field is used if you need to receive data from different hosts simultaneously. When set to 1, only a single host may open the TCP connection to the serial port. When set to 2, the specified number of hosts may open this port at the same time.  When multiple hosts establish a TCP connection to the serial port at the same time, the OnCell 3120-LTE-1 will duplicate the serial data and transmit it to all the hosts. Cellular or Ethernet data is sent on a first-in first-out basis to the serial port when data comes into the OnCell 3120-LTE-1 from the Cellular or Ethernet interface.	1
<b>TCP alive check interval</b>	This field specifies how long the OnCell 3120-LTE-1 will wait for a response to "keep alive" packets before closing the TCP connection. The OnCell 3120-LTE-1 checks connection status by sending periodic "keep alive" packets. If the remote host does not respond to the packet within the time specified in this field, the OnCell 3120-LTE-1 will force the existing TCP connection to close. For socket and device control modes, the OnCell 3120-LTE-1 will listen for another TCP connection from another host after closing the connection. If <b>TCP alive check time</b> is set to <b>0</b> , the TCP connection will remain open and will not send any "keep alive" packets.	7 min

**ATTENTION**

You should make sure the inactivity time value used here is less than the inactivity time value on the GSM/GPRS configuration page. The GSM/GPRS connection must be maintained in order to achieve the inactivity time behavior of the TCP connection.

Setting	Description	Factory Default
<b>Inactivity time</b>	This field specifies how long the OnCell 3120-LTE-1 will wait for incoming and outgoing data through the serial port before closing the TCP connection. The TCP connection is closed if there is no incoming or outgoing data through the serial port for the specified <b>Inactivity time</b> . If this field is set to <b>0</b> , the TCP connection is kept active until a connection close request is received.	0 ms

**ATTENTION**

If used, the Inactivity time setting should be greater than the Force transmit time. To prevent the unintended loss of data due to the session being disconnected, it is highly recommended that this value is set large enough so that the intended data transfer is completed.

Setting	Description	Factory Default
<b>Packet length</b>	The Packet length setting refers to the maximum amount of data that is allowed to accumulate in the serial port buffer before sending. At the default of 0 for packet length, no maximum amount is specified and data in the buffer will be sent as specified by the delimiter settings or when the buffer is full. When a packet length between 1 and 1024 bytes is specified, data in the buffer will be sent as soon it reaches the specified length.	0
<b>Delimiter 1</b> <b>Delimiter 2</b>	When <b>Delimiter 1</b> is enabled, the serial port will queue the data in the buffer and send the data to the Cellular or Ethernet port when a specific character, entered in hex format, is received.  A second delimiter character may be enabled and specified in the <b>Delimiter 2</b> field, so that both characters act as the delimiter to control when data should be sent.	00

**ATTENTION**

In order to enable a delimiter, packet length must be set to 0. **Delimiter 2** should only be enabled in conjunction with **Delimiter 1** and never on its own; otherwise there may be data errors. Even when a delimiter is enabled, the OnCell 3120-LTE-1 will still pack and send the data when the amount of data exceeds 1 KB.

Setting	Description	Factory Default
<b>Delimiter process</b>	The Delimiter process field determines how the data is handled when a delimiter is received. <b>Delimiter 1</b> must be enabled for this field to have effect. If Delimiters 1 and 2 are both enabled, both characters must be received for the delimiter process to take place. <ul style="list-style-type: none"> <li>• Delimiter: Data in the buffer will be transmitted when the delimiter is received.</li> <li>• Delimiter + 1: Data in the buffer will be transmitted after 1 additional byte is received following the delimiter.</li> <li>• Delimiter + 2: Data in the buffer will be transmitted after 2 additional bytes are received following the delimiter.</li> <li>• Strip Delimiter: Data in the buffer is first stripped of the delimiter before being transmitted.</li> </ul>	Delimiter

Setting	Description	Factory Default
<b>Force transmit</b>	This parameter defines how large a gap in serial communication the OnCell 3120-LTE-1 will allow before packing the serial data in its internal buffer for network transmission.  As data is received through the serial port, it is stored by the OnCell 3120-LTE-1 in the internal buffer. The OnCell 3120-LTE-1 transmits the data stored in the buffer via TCP/IP when	0 ms

Setting	Description	Factory Default
	<p>the internal buffer is full or as specified by the force-transmit time.</p> <p>When this field is set to 0, the force transmit time is disabled and transmission is determined solely by the data in the internal buffer. When the force transmit time is set to a value from 1 to 65535, the TCP/IP protocol software will pack the serial data received for transmission after the gap in serial communication exceeds the specified force transmit time.</p> <p>The optimal force-transmit time setting depends on your application. However, it must be set to a value that is more than one-character interval within the specified baudrate. For example, assume that the serial port is set to 1200 bps, 8 data bits, 1 stop bit, and no parity. In this case, the total number of bits needed to send a character is 10 bits, and the time required to transfer one character is <b>(10 (bits) / 1200 (bits/s)) × 1000 (ms/s) = 8.3 ms</b>. Therefore, you should set the force transmit time to be greater than 8.3 ms, so in this case, it must be greater than or equal to 10 ms.</p> <p>If it is necessary to send a series of characters in the same packet, the serial device will need to send that series of characters within the specified force transmit time, and the total length of data must be less than or equal to the OnCell 3120-LTE-1's internal buffer size (1 KB per port).</p>	

### Types of TCP Server Connection

#### Fixed Public IP for the OnCell

If your cellular service provider offers a fixed public IP address after you connect to the cellular network, you can access the OnCell 3120-LTE-1 from a host PC using either a private IP or public IP.

TCP Server mode

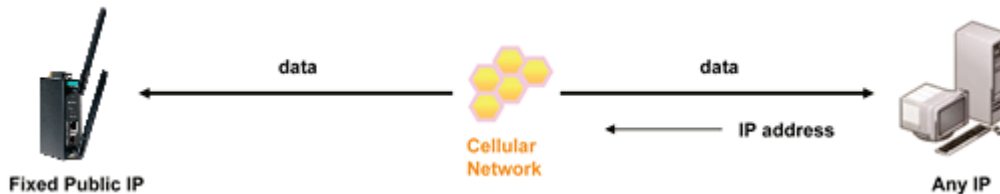

#### Using Auto IP report

If your cellular service provider offers a dynamic public IP address after you connect to the cellular network, you can access the OnCell 3120-LTE-1 from a host PC using a fixed public IP. Since the IP address of the OnCell 3120-LTE-1 is changed every time it is connected to the cellular network, the host IP can be aware of the change by the Auto IP Report message sent from the OnCell 3120-LTE-1. Please refer to *Auto IP report settings* for the format of the Auto IP Report Protocol.

TCP Server mode & Auto IP Report enabled

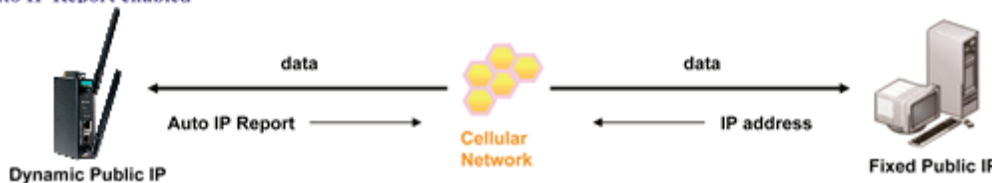

### Domain name with DDNS

If your cellular service provider offers a public IP address after you connect to the cellular network, you can also use the domain name to access the OnCell 3120-LTE-1. You would need to register with a DDNS service provider and then enable the DDNS function in the OnCell 3120-LTE-1. Please refer to Appendix B for more information.

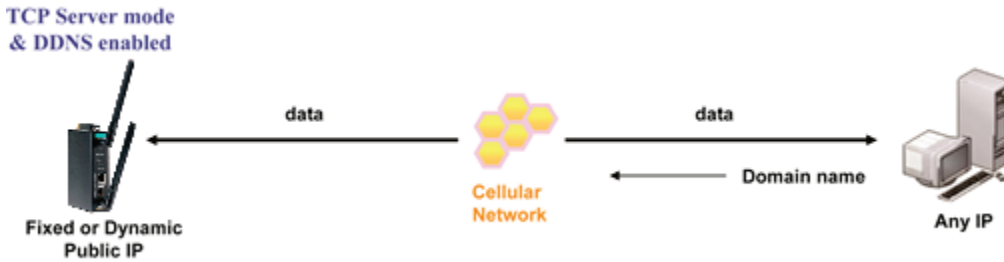

### Connecting TCP client and TCP server within the same cellular service provider

In order to connect properly, the IP addresses of the two OnCell devices must belong to the same subnetwork. To ensure that this is the case, use the same cellular service provider to connect the devices to the network. In addition, you will need to request that the cellular service provider provide you with two private IP addresses (e.g., 192.168.1.1 and 192.168.1.2).

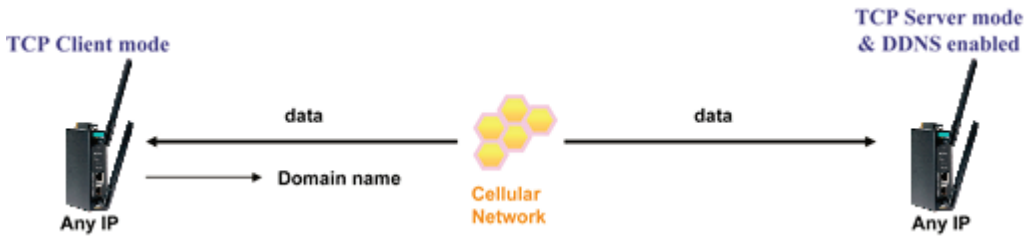

## TCP Client Modes

In TCP Client mode, the OnCell 3120-LTE-1 can actively establish a TCP connection to a pre-defined host computer when serial data arrives. After the data has been transferred, the OnCell 3120-LTE-1 can automatically disconnect from the host computer by using the Inactivity time settings.

As illustrated in the figure below, data transmission proceeds as follows:

1. The OnCell 3120-LTE-1, configured for TCP Client mode, requests a connection to the host.
2. Once the connection is established, data can be transmitted in both directions between the host and the OnCell 3120-LTE-1.

TCP Client mode includes optional data encryption using SSL.

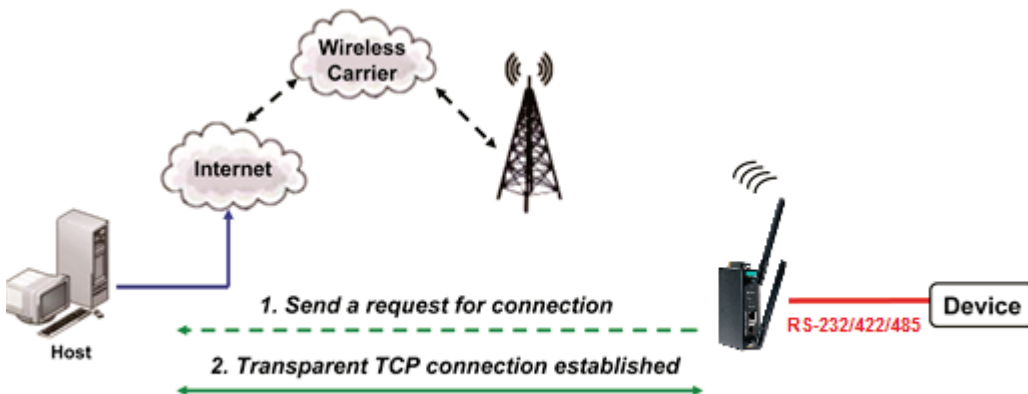



Operation Modes

Information

Interface Serial port 1  
 Application Socket  
 Mode TCP Client

Connection Settings

Secure connection  Enable  Disable

Destination address 1  Port

Designated local port 1

Destination address 2  Port

Designated local port 2

Destination address 3  Port

Designated local port 3

Destination address 4  Port

Designated local port 4

Connection control  ▼

Inactivity time  (0 to 65535 ms)

TCP alive check interval  (0 to 99 minutes)

Data Packing Settings

Packet length  (0 to 1024 bytes)

Delimiter 1  Enable  (2 hexadecimal digits. E.g., 0A)

Delimiter 2  Enable  (2 hexadecimal digits. E.g., 0A)

Delimiter process  ▼ (Processed only if Packet length is 0)

Force transmit interval  (0 to 65535 ms)

Setting	Description	Factory Default
Secure connection	If you select Enable, data sent through the Ethernet will be encrypted with SSL.	Disable
Destination address 1 through 4	Specifying an IP address allows the OnCell 3120-LTE-1 to connect actively to the remote host. At least one destination must be provided.	None
Data port	This is the TCP port number assignment for the serial port on the OnCell 3120-LTE-1. It is the port number that the serial port uses to listen to connections, and that other devices must use to contact the serial port. To avoid conflicts with well-known TCP ports, the default is set to 4001.	4001



**ATTENTION**

Up to 4 connections can be established between the OnCell 3120-LTE-1 and hosts. The connection speed or throughput may be low if any one of the four connections is slow, since the one slow connection will slow down the other 3 connections.



**ATTENTION**

The **Destination IP address** parameter can be the IP address, domain name, or the name defined in the host table. For some applications, the user may need to send the data actively to the remote destination domain name.

Setting	Description	Factory Default
Designated local port 1 through 4	Use these fields to specify designated local ports or leave blank and designated by system.	0
TCP alive check interval	This field specifies how long the OnCell 3120-LTE-1 will wait for a response to "keep alive" packets before closing the TCP connection. The OnCell 3120-LTE-1 checks connection status by sending periodic "keep alive" packets. If the remote host does not respond to the packet within the time specified in this field, the OnCell 3120-LTE-1 will force the existing TCP connection to close. For socket and device control modes, the	7 min

Setting	Description	Factory Default
	OnCell 3120-LTE-1 will listen for another TCP connection from another host after closing the connection. If <b>TCP alive check time</b> is set to <b>0</b> , the TCP connection will remain open and will not send any "keep alive" packets.	



**ATTENTION**

You should make sure the inactivity time value used here is less than the inactivity time value on the GSM/GPRS configuration page. The GSM/GPRS connection must be maintained in order to achieve the inactivity time behavior of the TCP connection

Setting	Description	Factory Default
<b>Inactivity time</b>	This field specifies how long the OnCell 3120-LTE-1 will wait for incoming and outgoing data through the serial port before closing the TCP connection. The TCP connection is closed if there is no incoming or outgoing data through the serial port for the specified <b>Inactivity time</b> . If this field is set to <b>0</b> , the TCP connection is kept active until a connection close request is received.	0ms



**ATTENTION**

If used, the Inactivity time setting should be greater than the Force transmit time. To prevent the unintended loss of data due to the session being disconnected, it is highly recommended that this value is set large enough so that the intended data transfer is completed.



**ATTENTION**

Inactivity time is ONLY active when Connection Control (see below) is set to Any character/ Inactivity time.

Setting	Description	Factory Default
<b>Connection control</b>	This setting determines the parameters under which a TCP connection is established or disconnected. The different options are given in the following table. In general, both the Connect condition and Disconnect conditions are given.	Startup/ None)

Option	Description
Startup/None (default)	A TCP connection will be established on startup, and will remain active indefinitely.
Any Character/None	TCP connection will be established when any character is received from the serial interface, and will remain active indefinitely.
Any Character/ Inactivity Time	A TCP connection will be established when any character is received from the serial interface, and will be disconnected when Inactivity time is reached.
DSR On/DSR Off	A TCP connection will be established when a DSR signal of OnCell is "On", and will remain active indefinitely.
DSR On/None	A TCP connection will be established when a DSR "On" signal is received, and will remain active indefinitely.
DCD On/DCD Off	A TCP connection will be established when a DCD signal of OnCell is "On", and will remain active indefinitely.

DCD On/None	A TCP connection will be established when a DCD "On" signal is received, and will remain active indefinitely.
-------------	---

Setting	Description	Factory Default
<b>Packing length</b>	The <b>Packing length</b> setting refers to the maximum amount of data that is allowed to accumulate in the serial port buffer before sending. At the default of 0 for packet length, no maximum amount is specified and data in the buffer will be sent as specified by the delimiter settings or when the buffer is full. When a packet length between 1 and 1024 bytes is specified, data in the buffer will be sent as soon it reaches the specified length.	0
<b>Delimiter 1</b> <b>Delimiter 2</b>	When <b>Delimiter 1</b> is enabled, the serial port will queue the data in the buffer and send the data to the Cellular or Ethernet port when a specific character, entered in hex format, is received. A second delimiter character may be enabled and specified in the <b>Delimiter 2</b> field, so that both characters act as the delimiter to control when data should be sent.	00



**ATTENTION**

In order to enable a delimiter, packet length must be set to 0. **Delimiter 2** should only be enabled in conjunction with **Delimiter 1** and never on its own; otherwise there may be data errors. Even when a delimiter is enabled, the OnCell 3120-LTE-1 will still pack and send the data when the amount of data exceeds 1 KB.

Setting	Description	Factory Default
<b>Delimiter process</b>	The Delimiter process field determines how the data is handled when a delimiter is received. <b>Delimiter 1</b> must be enabled for this field to have effect. If Delimiters 1 and 2 are both enabled, both characters must be received for the delimiter process to take place. <ul style="list-style-type: none"> <li>• Delimiter: Data in the buffer will be transmitted when the delimiter is received.</li> <li>• Delimiter + 1: Data in the buffer will be transmitted after 1 additional byte is received following the delimiter.</li> <li>• Delimiter + 2: Data in the buffer will be transmitted after 2 additional bytes are received following the delimiter.</li> <li>• Strip Delimiter: Data in the buffer is first stripped of the delimiter before being transmitted.</li> </ul>	Delimiter
<b>Force transmit</b>	This parameter defines how large a gap in serial communication the OnCell 3120-LTE-1 will allow before packing the serial data in its internal buffer for network transmission. <p>As data is received through the serial port, it is stored by the OnCell 3120-LTE-1 in the internal buffer. The OnCell 3120-LTE-1 transmits the data stored in the buffer via TCP/IP when the internal buffer is full or as specified by the force-transmit time.</p> <p>When this field is set to 0, the force transmit time is disabled and transmission is determined solely by the data in the internal buffer. When the force transmit time is set to a value from 1 to 65535, the TCP/IP protocol software will pack the</p>	0 ms

Setting	Description	Factory Default
	<p>serial data received for transmission after the gap in serial communication exceeds the specified force transmit time. The optimal force-transmit time setting depends on your application. However, it must be set to a value that is more than one-character interval within the specified baudrate. For example, assume that the serial port is set to 1200 bps, 8 data bits, 1 stop bit, and no parity. In this case, the total number of bits needed to send a character is 10 bits, and the time required to transfer one character is <b>(10 (bits) / 1200 (bits/s)) × 1000 (ms/s) = 8.3 ms</b>. Therefore, you should set the force transmit time to be greater than 8.3 ms, so in this case, it must be greater than or equal to 10 ms.</p> <p>If it is necessary to send a series of characters in the same packet, the serial device will need to send that series of characters within the specified force transmit time, and the total length of data must be less than or equal to the OnCell 3120-LTE-1's internal buffer size (1 KB per port).</p>	

## Types of TCP Client Connection

### TCP Client to PC's IP address

The OnCell 3120-LTE-1 will only be able to connect to a host PC if the PC is using a public IP address.

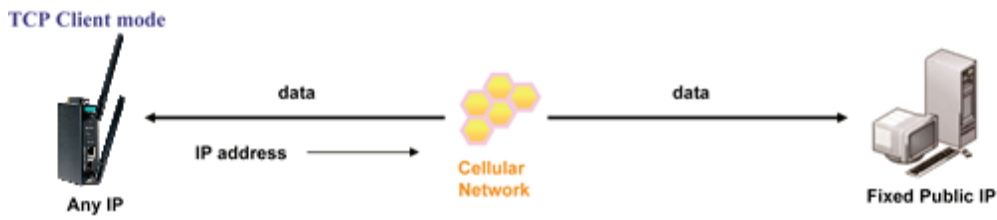

### TCP Client to PC's domain name

To connect to a host PC, the host PC must be configured with public IP address. If it is using a dynamic public IP, then the OnCell 3120-LTE-1 can connect to it using the host's domain name. Please refer to Appendix B for more information.

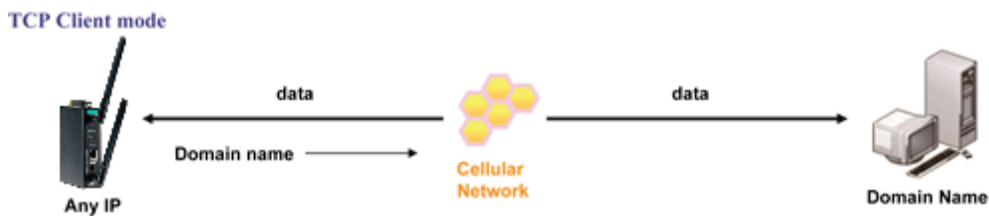

### Connecting TCP client and TCP server within the same cellular service provider

In order to connect properly, the IP addresses of the two OnCell devices must belong to the same subnetwork. To ensure that this is the case, use the same cellular service provider to connect the devices to the network. In addition, you will need to request that the cellular service provider provide you with two private IP addresses (e.g., 192.168.1.1 and 192.168.1.2).

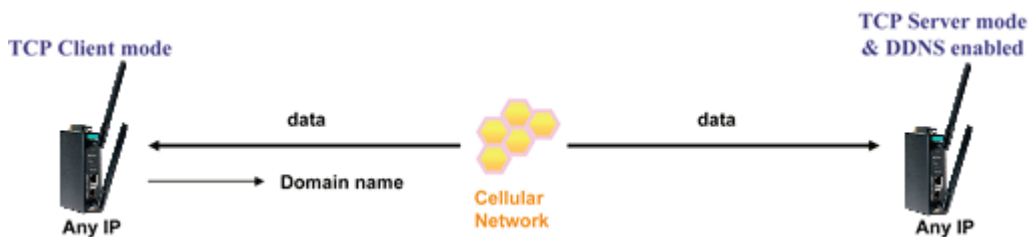

## UDP Mode

Compared to TCP communication, UDP is faster and more efficient. In UDP mode, you can unicast to one host or multicast to multiple hosts and the serial device can receive data from one or multiple host computers. These traits make UDP mode especially well-suited for message display applications.

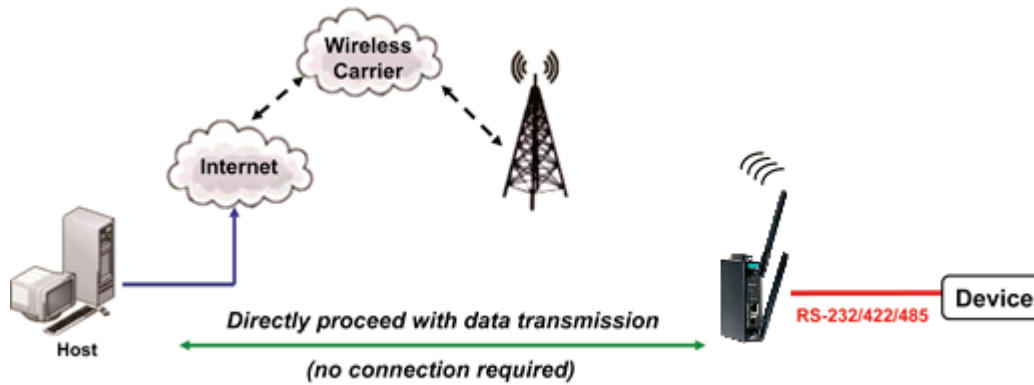

**Operation Modes (Updated)**

**Information**

Interface: Serial port 1  
 Application: Socket  
 Mode: UDP

**Connection Settings**

Destination IP address 1: Start [ ] End [ ] Port 4001  
 Destination IP address 2: Start [ ] End [ ] Port 4001  
 Destination IP address 3: Start [ ] End [ ] Port 4001  
 Destination IP address 4: Start [ ] End [ ] Port 4001  
 Local listening port: 4001

**Data Packing Settings**

Packet length: 0 (0 to 1024 bytes)  
 Delimiter 1:  Enable 00 (2 hexadecimal digits. E.g., 0A)  
 Delimiter 2:  Enable 00 (2 hexadecimal digits. E.g., 0A)  
 Delimiter process: Delimiter [ ] (Processed only if Packet length is 0)  
 Force transmit interval: 0 (0 to 65535 ms)

Submit

Setting	Description	Factory Default
<b>Destination address 1 through 4</b>	In UDP mode, you may specify up to 4 ranges of IP addresses for the serial port to connect to. At least one destination range must be provided.	None



**ATTENTION**

The maximum selectable IP address range is 64 addresses. However, when using multicast, you may enter IP addresses of the form xxx.xxx.xxx.255 in the Begin field. For example, enter 192.168.127.255 to allow the OnCell 3120-LTE-1 to broadcast UDP packets to all hosts with IP addresses between 192.168.127.1 and 192.168.127.254.

Setting	Description	Factory Default
<b>Local listen port</b>	This is the UDP port that the OnCell 3120-LTE-1 listens to and that other devices must use to contact the OnCell 3120-LTE-1. To avoid conflicts with well-known UDP ports, the default is set to 4001.	4001
<b>Packing length</b>	The <b>Packing length</b> setting refers to the maximum amount of data that is allowed to accumulate in the serial port buffer before sending. At the default of 0 for packet length, no maximum amount is specified and data in the buffer will be sent as specified by the delimiter settings or when the buffer is full. When a packet length between 1 and 1024 bytes is	0

Setting	Description	Factory Default
	specified, data in the buffer will be sent as soon it reaches the specified length.	
<b>Delimiter 1</b> <b>Delimiter 2</b>	When <b>Delimiter 1</b> is enabled, the serial port will queue the data in the buffer and send the data to the Cellular or Ethernet port when a specific character, entered in hex format, is received. A second delimiter character may be enabled and specified in the <b>Delimiter 2</b> field, so that both characters act as the delimiter to control when data should be sent.	00

**ATTENTION**

In order to enable a delimiter, packet length must be set to 0. **Delimiter 2** should only be enabled in conjunction with **Delimiter 1** and never on its own; otherwise there may be data errors. Even when a delimiter is enabled, the OnCell 3120-LTE-1 will still pack and send the data when the amount of data exceeds 1 KB.

Setting	Description	Factory Default
<b>Delimiter process</b>	<p>The Delimiter process field determines how the data is handled when a delimiter is received. <b>Delimiter 1</b> must be enabled for this field to have effect. If Delimiters 1 and 2 are both enabled, both characters must be received for the delimiter process to take place.</p> <ul style="list-style-type: none"> <li>• Delimiter: Data in the buffer will be transmitted when the delimiter is received.</li> <li>• Delimiter + 1: Data in the buffer will be transmitted after 1 additional byte is received following the delimiter.</li> <li>• Delimiter + 2: Data in the buffer will be transmitted after 2 additional bytes are received following the delimiter.</li> <li>• Strip Delimiter: Data in the buffer is first stripped of the delimiter before being transmitted.</li> </ul>	Delimiter
<b>Force transmit</b>	<p>This parameter defines how large a gap in serial communication the OnCell 3120-LTE-1 will allow before packing the serial data in its internal buffer for network transmission.</p> <p>As data is received through the serial port, it is stored by the OnCell 3120-LTE-1 in the internal buffer. The OnCell 3120-LTE-1 transmits the data stored in the buffer via TCP/IP when the internal buffer is full or as specified by the force-transmit time.</p> <p>When this field is set to 0, the force transmit time is disabled and transmission is determined solely by the data in the internal buffer. When the force transmit time is set to a value from 1 to 65535, the TCP/IP protocol software will pack the serial data received for transmission after the gap in serial communication exceeds the specified force transmit time.</p> <p>The optimal force-transmit time setting depends on your application. However, it must be set to a value that is more than one-character interval within the specified baudrate. For example, assume that the serial port is set to 1200 bps, 8 data bits, 1 stop bit, and no parity. In this case, the total number of bits needed to send a character is 10 bits, and the time required to transfer one character is <b>(10 (bits) / 1200</b></p>	0 ms

Setting	Description	Factory Default
	<p><math>(\text{bits/s}) \times 1000 (\text{ms/s}) = 8.3 \text{ ms}</math>. Therefore, you should set the force transmit time to be greater than 8.3 ms, so in this case, it must be greater than or equal to 10 ms.</p> <p>If it is necessary to send a series of characters in the same packet, the serial device will need to send that series of characters within the specified force transmit time, and the total length of data must be less than or equal to the OnCell 3120-LTE-1's internal buffer size (1 KB per port).</p>	

## Types of UDP Connection

### Fixed Public IPs for both OnCell and Host PC

If your cellular service provider offers a fixed public IP address after you connect to the cellular network, you can access the OnCell 3120-LTE-1 from a host PC that has a fixed public IP.

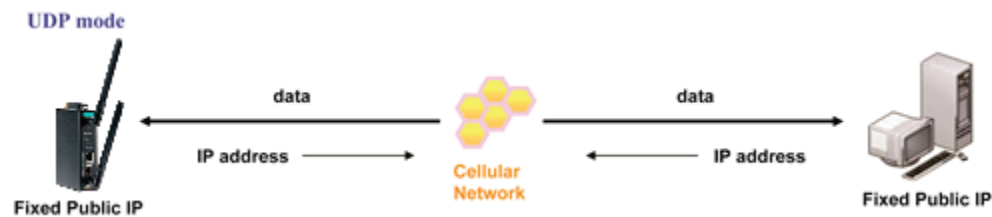

### Domain name with DDNS

If your cellular service provider assigns a public IP address after you connect to the cellular network, you can also access the OnCell 3120-LTE-1 using the domain name. If your service provider assigns a public IP address (either fixed or dynamic) to your cellular device and your control center is the side that initiates the connection, you can enable the DDNS function and UDP mode to allow other devices on the Internet to connect to your device using its domain name. This will ensure that your device will remain reachable even when its public IP address is updated. Note that you will need to register your device with a DDNS server. Please refer to Appendix B for more information.

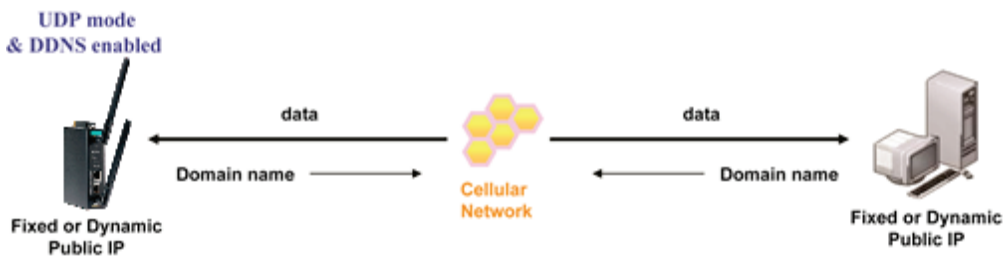

## Communication Parameters

**Communication Parameters**

**Port**

**Port alias**

Setting	Description	Factory Default
Port alias	This optional field allows you to assign an alias to a port for easier identification.	None



Serial Parameters	
Baud rate	115200 ▼
Data bits	8 ▼
Stop bits	1 ▼
Parity	None ▼
Flow control	RTS/CTS ▼
Interface	RS-232 ▼
<input type="button" value="Submit"/>	



**ATTENTION**

The serial parameters for the each serial port on the OnCell 3120-LTE-1 should match the parameters used by the connected serial device. You may need to refer to your serial device’s user’s manual to determine the appropriate serial communication parameters.

Setting	Description	Factory Default
<b>Baudrate</b>	This field configures the port’s baudrate. Select one of the standard baudrates from the dropdown box, or select <b>Other</b> and then type the desired baudrate in the input box.	115200



**ATTENTION**

The serial parameters for the each serial port on the OnCell 3120-LTE-1 should match the parameters used by the connected serial device. You may need to refer to your serial device’s user’s manual to determine the appropriate serial communication parameters.

Setting	Description	Factory Default
<b>Data bits</b>	The Packet length setting refers to the maximum amount of data that is allowed to accumulate in the serial port buffer before sending. At the default of 0 for packet length, no maximum amount is specified and data in the buffer will be sent as specified by the delimiter settings or when the buffer is full. When a packet length between 1 and 1024 bytes is specified, data in the buffer will be sent as soon it reaches the specified length.	8
<b>Stop bits</b>	When <b>Delimiter 1</b> is enabled, the serial port will queue the data in the buffer and send the data to the Cellular or Ethernet port when a specific character, entered in hex format, is received. A second delimiter character may be enabled and specified in the <b>Delimiter 2</b> field, so that both characters act as the delimiter to control when data should be sent.	1
<b>Parity</b>	This field configures the parity parameter.	None
<b>Flow control</b>	This field configures the flow control type.	RTS/CTS
<b>Interface</b>	You may configure the serial interface to RS-232, RS-422, RS-485 2-wire, or RS-485 4-wire.	RS-232

## Data Buffering/Log

The OnCell 3120-LTE-1 supports port buffering to prevent the loss of serial data when the Cellular or Ethernet connection is down. Port buffering can be used in Real COM, Reverse Real COM, RFC2217, TCP Server, TCP Client modes. For other modes, the port buffering settings will have no effect. The maximum buffer up to 256K, the data over 256K will overwrite previous data buffering.

**Port 1**

**Port buffering (256K)**  Enable  Disable

**Serial data logging (256K)**  Enable  Disable

Submit

Setting	Description	Factory Default
<b>Port buffering</b>	You may enable port buffering by setting this field to <b>Enable</b> .	Disable
<b>Serial data logging</b>	If this field is set to Yes, the OnCell 3120-LTE-1 will store data logs on the system RAM for all serial ports. Note that this data is not saved when the OnCell 3120-LTE-1 is powered off.	Disable

## Cipher Settings

Click **Cipher Settings** to set the port cipher settings for data encryption.

**Cipher Settings**

**Port 1**

**Use up/down to sort the cipher list.**

**Secure Mode (SSL) Ciphers**

DHE-RSA-AES256-SHA ▲  
 AES256-SHA  
 EDH-RSA-DES-CBC3-SHA  
 DES-CBC3-SHA  
 DES-CBC3-MD5  
 DHE-RSA-AES128-SHA  
 AES128-SHA  
 RC4-SHA  
 RC4-MD5  
 EDH-RSA-DES-CBC-SHA  
 DES-CBC-SHA  
 DES-CBC-MD5 ▼

Up

Down

Submit

# Logs and Notification

Since industrial-grade devices are often located at the endpoints of a system, these devices will not always know what is happening elsewhere on the network. This means that these devices must provide system maintainers with real-time alarm messages. Even when system administrators are out of the control room for an extended period, they can still be informed of the status of devices almost instantaneously when exceptions occur.

In addition to logging these events, the OnCell 3120-LTE-1 supports different approaches to warn engineers automatically, such as SNMP trap and email.

## System Log

### System Log Event Types

Detail information for grouped events is shown in the following table. You can select the **Enable logging** check box to enable the selected event types. All default values are enabled (checked). The log for system events can be seen in **Status > System Log**.

Syslog Event Types	
Event Type	<input type="checkbox"/> Enable Logging
System-related events	<input checked="" type="checkbox"/> Active
Network-related events	<input checked="" type="checkbox"/> Active
Configuration-related events	<input checked="" type="checkbox"/> Active
VPN events	<input checked="" type="checkbox"/> Active

The following table describes the types of system logs:

System-related events	Event is triggered when...
System restart (warm start)	The OnCell 3120-LTE-1 is rebooted, such as when its settings are changed (IP address, subnet mask, etc.).
Power saving mode on	System entered Hibernation/Sleep mode, triggered by Schedule Management or by Remote SMS Control.
Power saving mode off	System left Hibernation/Sleep mode, triggered by Schedule Management or by Remote SMS Control.
Network-related events	Event is triggered when...
LAN link on	The LAN port is connected to a device or network. It takes 0.5 seconds for the system to detect and log this event.
LAN link off	The port is disconnected (e.g., the cable is pulled out, or the opposing device shuts down). It takes 0.5 seconds for the system to detect and log this event.
WAN backup (primary > backup)	Failed to ping the remote host from the primary WAN interface and switched to the backup WAN.
WAN backup (backup > primary)	Successfully pinged the remote host from the primary WAN interface and switched back to the primary WAN.
Config-related events	Event is triggered when...
Configuration changed	A configuration item has been changed.
Configuration file import via Web Console	The configuration file is imported to the OnCell 3120-LTE-1.
Console authentication failure	An incorrect password is entered.
Firmware upgraded	The OnCell 3120-LTE-1's firmware is updated.
VPN events	Event is triggered when...
VPN events	Refer to <a href="#">VPN System Log Description</a> .

# Syslog

This function provides the event logs for the Syslog server. The function supports up to three configurable Syslog servers and Syslog server UDP port numbers. When an event occurs, the event will be sent as a Syslog UDP packet to the specified Syslog servers.

## Syslog Event Types

Detail information for the grouped events is shown in the following table. You can the **Enable log** check box to enable the selected event types. All default values are enabled (checked).

For information on the event types, refer to the *System Log Event Types* section.

Syslog Event Types	
Event Type	<input type="checkbox"/> Enable Logging
System-related events	<input checked="" type="checkbox"/> Active
Network-related events	<input checked="" type="checkbox"/> Active
Configuration-related events	<input checked="" type="checkbox"/> Active
VPN events	<input checked="" type="checkbox"/> Active

## Syslog Server Settings

You can configure the parameters for your Syslog server on the **Syslog Server Settings** screen.

Syslog Server Settings	
Syslog server 1	<input type="text"/>
Syslog port	<input type="text" value="514"/>
Syslog server 2	<input type="text"/>
Syslog port	<input type="text" value="514"/>
Syslog server 3	<input type="text"/>
Syslog port	<input type="text" value="514"/>

Field	Description	Factory Default
Syslog server 1/2/3	Enter the IP address of the 1st/ 2nd/ 3rd Syslog Server	N/A
Syslog port	Enter the UDP port for the syslog server.	514

## Email Notifications

### Notification Event Types

Select the **Active** checkbox to enable an event item. By default, all values are deactivated (unchecked). For information on the event types, refer to the System Log Event Types section.

Notification Event Types	
Event Type	<input type="checkbox"/> Enable Notification
Cold start	<input type="checkbox"/> Active
Warm start	<input type="checkbox"/> Active
Configuration changed	<input type="checkbox"/> Active
CWAN IP changed	<input type="checkbox"/> Active
Password changed	<input type="checkbox"/> Active
Console authentication failure	<input type="checkbox"/> Active
LAN 1 link On	<input type="checkbox"/> Active
LAN 1 link Off	<input type="checkbox"/> Active
LAN 2 link On	<input type="checkbox"/> Active
LAN 2 link Off	<input type="checkbox"/> Active
Cellular close temperature range	<input type="checkbox"/> Active
Cellular over temperature range	<input type="checkbox"/> Active

### Email Server Settings

The E-mail server settings determine how e-mail warnings are sent for system and serial port events. You may configure up to 4 e-mail addresses to receive automatic warnings.

Email Server Settings	
Mail server (SMTP)	<input type="text"/>
User name	<input type="text"/>
Password	<input type="text"/>
From email address	<input type="text"/>
To email address 1	<input type="text"/>
To email address 2	<input type="text"/>
To email address 3	<input type="text"/>
To email address 4	<input type="text"/>



#### ATTENTION

Consult your Network Administrator or ISP for the proper mail server settings. The Auto warning function may not work properly if it is not configured correctly. The OnCell 3120-LTE-1's SMTP AUTH supports LOGIN, PLAIN, and CRAM-MD5 (RFC 2554).

Setting	Description	Factory Default
Mail server	This field is for your mail server's domain name or IP address.	N/A

<b>User name</b>	This field is for your mail server’s user name, if required.	N/A
<b>Password</b>	This field is for your mail server’s password, if required.	N/A
<b>From email address</b>	This is the email address from which automatic email warnings will be sent.	N/A
<b>To email address 1 to 4</b>	This is the email address or addresses to which the automatic email warnings will be sent.	N/A

## Trap

Traps can be used to signal abnormal conditions (notifications) to a management station. This trap-driven notification can make your network more efficient.

Because a management station usually takes care of a large number of devices that have a large number of objects, it will be overloading for the management station to poll or send requests to query every object on every device. It would be better if the managed device agent could notify the management station by sending a message known as a trap for the event.

## Trap Event Types

Select Active to enable the event types.

For information on the event types, refer to the System Log Event Types section.

**Trap Event Types**

Event Type	<input type="checkbox"/> Enable Notification
Cold start	<input type="checkbox"/> Active
Warm start	<input type="checkbox"/> Active
Configuration changed	<input type="checkbox"/> Active
Console authentication failure	<input type="checkbox"/> Active
LAN 1 link On	<input type="checkbox"/> Active
LAN 1 link Off	<input type="checkbox"/> Active
LAN 2 link On	<input type="checkbox"/> Active
LAN 2 link Off	<input type="checkbox"/> Active

## SNMP Trap Receiver Settings

SNMP traps are defined in SMIV1 MIBs (SNMPv1) and SMIV2 MIBs (SNMPv2c). The two styles are basically equivalent, and it is possible to convert between the two. You can set the parameters for SNMP trap receivers through the web page.

**SNMP Trap Receiver Settings**

1st trap version:

1st trap server IP/name:

1st trap community:

2nd trap version:

2nd trap server IP/name:

2nd trap community:

3rd trap version:

3rd trap server IP/name:

3rd trap community:

Field	Description	Default setting
Trap version	Select the SNMP version for SNMP traps.	V1
Trap server IP/name	Enter the IP address or domain name of the SNMP trap server.	N/A
Trap community	Enter the community string or password (up to 31 characters) for authentication.	alert

## SMS

### SMS Event Types

Select **Active** to enable the event types. For information on the event types, refer to the *System Log Event Types* section.

**SMS Event Types**

Event	<input type="checkbox"/> Enable Notification
Cold start	<input type="checkbox"/> Active
Warm start	<input type="checkbox"/> Active
Configuration changed	<input type="checkbox"/> Active
CWAN IP changed	<input type="checkbox"/> Active
Password changed	<input type="checkbox"/> Active
Console authentication failure	<input type="checkbox"/> Active
LAN 1 link On	<input type="checkbox"/> Active
LAN 1 link Off	<input type="checkbox"/> Active
LAN 2 link On	<input type="checkbox"/> Active
LAN 2 link Off	<input type="checkbox"/> Active
Cellular close temperature range	<input type="checkbox"/> Active

### SMS Alert Settings

You can set the OnCell 3120-LTE-1 to send SMS notifications to up to four phone numbers and select a message encoding format in the **SMS Alert Settings** screen.

**SMS Alert Settings**

To phone number 1

To phone number 2

To phone number 3

To phone number 4

Field	Description	Factory Default
To phone number 1/2/3/4	Enter the phone numbers to which the OnCell 3120-LTE-1 sends SMS notifications.	

# Status

## Serial

### Serial to Network Connections

Go to **Serial to Network Connections** under **Serial Status** to view the operation mode and status of each connection for each serial port. All monitor functions will refresh automatically every 15 seconds.

The Real COM mode, Reverse Real COM mode and TCP server mode support up to 2 devices connection, TCP Client mode support up to 4 devices connection.

Serial to Network Connections		
<input checked="" type="checkbox"/> Auto refresh		
Port	OP Mode	Connections
1	Device Control/RealCOM	[192.168.127.55]

### Serial Port Status

Go to **Serial Port Status** under **Serial Status** to view the current status of each serial port. **Serial Port Status Buffering** monitors port buffering usage (bytes) of the serial port. Go to **Serial Port Settings > Port 1 > Data Buffering/Log** to enable Port buffering function.

A green dot indicates active, and a gray dot indicates inactive

Serial Port Status											
<input checked="" type="checkbox"/> Auto refresh											
Port	TxCnt	RxCnt	TxTotalCnt	RxTotalCnt	DSR	DTR	RTS	CTS	DCD	Buffering	
1	64	68	64	68						0	

### Serial Port Error Count

Go to **Serial Port Error Count** under **Serial Status** to view the error count for each serial port.

Serial Port Error Count				
<input checked="" type="checkbox"/> Auto refresh				
Port	ErrCnt			
	Frame	Parity	Overrun	Break
1	7	10	0	119

	Description
<b>Frame</b>	Errors due to wrong Baudrate, Parity (even/odd), and Stop bit settings.
<b>Parity</b>	Errors in parity setting (parity on / off) between both sites.
<b>Overrun</b>	The number of times the operation-mode application overload in order to handle the data transmission.
<b>Break</b>	The transmission breaks originating from serial devices connected behind the OnCell 3120-LTE-1



## Serial Port Settings

Go to **Serial Port Settings** under **Serial Status** to view a summary of the settings for each serial port.

Serial Port Settings									
<input checked="" type="checkbox"/> Auto refresh									
Port	Baud Rate	Data Bits	Stop Bits	Parity	Flow Control		FIFO	Interface	
					RTS/CTS	XON/XOFF			
1	115200	8	1	None	On	Off	Disable	RS-232	

## Serial Data Log

Data logs for the serial port can be viewed in ASCII or HEX format. After selecting the serial port and format, you may click **Select all** to select the entire log if you wish to copy and paste the contents into a text file.

R - Receiver / T - Transmission to the serial device.

**Serial Data Logs**

Select port Port1 [ASCII][HEX]

```

2016/12/5 22:38:12[R:9] Moxa-Test
2016/12/5 22:38:14[R:9] Moxa-Test
2016/12/5 22:38:16[R:9] Moxa-Test
2016/12/5 22:38:18[R:9] Moxa-Test
2016/12/5 22:38:20[R:9] Moxa-Test
2016/12/5 22:38:22[R:9] Moxa-Test
2016/12/5 22:38:24[R:9] Moxa-Test
2016/12/5 22:38:26[R:9] Moxa-Test
2016/12/5 22:38:28[R:9] Moxa-Test
2016/12/5 22:38:30[R:9] Moxa-Test
2016/12/5 22:38:32[R:9] Moxa-Test
2016/12/5 22:38:34[R:9] Moxa-Test
2016/12/5 22:38:37[R:9] Moxa-Test
2016/12/5 22:38:39[R:9] Moxa-Test
2016/12/5 22:38:41[R:9] Moxa-Test
2016/12/5 22:38:43[R:9] Moxa-Test
2016/12/5 22:38:45[R:9] Moxa-Test
2016/12/5 22:38:47[R:9] Moxa-Test
2016/12/5 22:38:49[R:9] Moxa-Test
2016/12/5 22:38:51[R:9] Moxa-Test
                
```

↙

## Cipher Usage Status

Cipher Usage Status			
<input checked="" type="checkbox"/> Auto refresh			
Port	OP Mode	Connections	Cipher
1	Device Control/Real COM		

## VPN

### VPN System Log Description

The following table lists the system logs for the VPN feature. [VPN name] indicates the name of the VPN tunnel you have created on the OnCell 3120-LTE-1.

System Log Entry	Description
[VPN name] mismatch of PSK	Pre-shared key mismatch.
[VPN name] Phase 1 start	VPN tunnel phase 1 start.
[VPN name] Phase 1 pass	VPN tunnel phase 1 pass.
[VPN name] Phase 2 start	VPN tunnel phase 2 start.
[VPN name] Phase 2 pass	VPN tunnel phase 2 pass.
[VPN name] received Delete ISAKMP SA	Remote VPN tunnel request to delete ISAKMP SA.
[VPN name] no Preshared Key Found	No pre-shared key is found.
[VPN name] policy doesn't allow PRESHARED KEY	The encryption algorithm does not allow pre-shared key.
[VPN name] policy doesn't allow RSASIG	VPN encrypt algorithm does not allow RSA or X.509.
[VPN name] DPD timeout - declaring peer dead	No response from a peer. PDP timeout.
[VPN name] DPD: Hold connection	Clear the remote VPN SA and keep the peer routing table status.
[VPN name] DPD: Clearing Connection	Clear the remote VPN SA and peer routing table status.
[VPN name] DPD: Restarting Connection	Renegotiate VPN SA immediately.
[VPN name] encrypt alg is different	VPN encryption mismatch.
[VPN name] hash alg is different	VPN hash mismatch.
[VPN name] DH group is different	VPN Diffie-Hellman group mismatch.
[VPN name] Ignore initial Aggr message	Ignore aggressive requests from a remote VPN gateway.
[VPN name] Maybe ID format error	Invalid local or remote VPN ID format.
[VPN name] we require peer ID differ from peer declares ID	Remote ID mismatch.
[VPN name] no suitable connection for peer	No corresponding VPN connection for a remote peer from the VPN responder.
[VPN name] connect_fail_log:ip_port	Fail to route VPN connection to [IP address].
[VPN name] send payload name	Send "VPN_INVALID_KEY_INFORMATION, INVALID_CERTIFICATE or...." to a remote VPN gateway.
[VPN name] receive payload name	Receive "VPN_INVALID_KEY_INFORMATION, INVALID_CERTIFICATE, or ..." from a remote VPN gateway.

### IPsec Logs

The IPsec triggered events are recorded in IPsec Logs. You can export the log contents to an available viewer by clicking **Export Log**. You can use the **Clear Log** button to clear the log contents and the **Refresh** button to refresh the log.

```

"sandiago2"[1] 49.216.148.168 #12: NAT-Traversal: Result using draft-ietf-ipsec-nat-t-ike (MacOS X): peer is NATed
"sandiago2"[1] 49.216.148.168 #12: transition from state STATE_MAIN_R1 to state STATE_MAIN_R2
"sandiago2"[1] 49.216.148.168 #12: STATE_MAIN_R2: sent MR2, expecting MI3
"sandiago2"[1] 49.216.148.168 #12: Main mode peer ID is ID_IPV4_ADDR: '192.168.127.253'
|   match_id a=192.168.127.253
|   b=192.168.127.253
|   results matched
"sandiago2"[1] 49.216.148.168 #12: transition from state STATE_MAIN_R2 to state STATE_MAIN_R3
"sandiago2"[1] 49.216.148.168 #12: new NAT mapping for #12, was 49.216.148.168:57473, now 49.216.148.168:57474
"sandiago2"[1] 49.216.148.168 #12: STATE_MAIN_R3: sent MR3, ISAKMP SA established {auth=OAKLEY_PRESHARED_KEY cipher=oakley_des_cbc_64 prf=oakley_md5 group=modp1024}
"sandiago2"[1] 49.216.148.168 #12: the peer proposed: 192.168.128.0/24:0/0 -> 192.168.127.0/24:0/0
"sandiago2"[1] 49.216.148.168 #12: find_client_connection starting with sandiago2
"sandiago2"[1] 49.216.148.168 #12: looking for 192.168.128.0/24:0/0 -> 192.168.127.0/24:0/0
"sandiago2"[1] 49.216.148.168 #12: concrete checking against sr#0 192.168.128.0/24 ->
    
```

Export Log Clear Log Refresh

## OpenVPN Status and Logs

The OpenVPN triggered events at Server and Clients are recorded in each Status and Logs.

You can export the log contents to an available viewer by clicking **Export Log**. You can use the **Clear Log** button to clear the log contents and the **Refresh** button to refresh the log.

**Server Status**

```

OpenVPN CLIENT LISTUpdated,Thu Dec 29 09:50:26 2016Common Name,Real Address,Bytes Received,Bytes Sent,Connected Sinceadmin,101.14.19.200:41344,1068,2534,Thu Dec 29 09:50:12 2016ROUTING TABLEVirtual Address,Common Name,Real Address,Last Ref192.168.10.6,admin,101.14.19.200:41344,Thu Dec 29 09:50:14 2016192.168.128.0/24,admin,101.14.19.200:41344,Thu Dec 29 09:50:14 2016GLOBAL STATSMax bcast/mcast queue length,0END
    
```

Export Status Log Refresh

**Server Logs**

```

Thu Dec 29 09:48:15 2016 OpenVPN 2.3.10 mips-be-linux-gnu [SSL (OpenSSL)] [LZO] [EPOLL] [MH] [IPv6] built on Dec 23 2016Thu Dec 29 09:48:15 2016 library versions: OpenSSL 1.0.0d 8 Feb 2011, LZO 2.09Thu Dec 29 09:48:15 2016 NOTE: the current --script-security setting may allow this configuration to call user-defined scriptsThu Dec 29 09:48:16 2016 WARNING: POTENTIALLY DANGEROUS OPTION --client-cert-not-required may accept clients which do not present a certificateThu Dec 29 09:48:16 2016 WARNING: file '/configData/ovpn/ovpnsvr/private/srvKey.pem' is group or others accessibleThu Dec 29 09:48:16 2016 TUN/TAP device tun0 openedThu Dec 29 09:48:16 2016 do_ifconfig, tt->ipv6=0, tt->did_ifconfig_ipv6_setup=0Thu Dec 29 09:48:16 2016 /sbin/ifconfig tun0 192.168.10.1 pointopoint 192.168.10.2 mtu 1500Thu Dec 29 09:48:16 2016 UDPv4 link local (bound): [undef]Thu Dec 29 09:48:16 2016 UDPv4 link remote: [undef]Thu Dec 29 09:48:16 2016 Initialization Sequence CompletedThu Dec 29 09:50:14 2016 101.14.19.200:41344 [admin] Peer Connection Initiated with [AF_INET]101.14.19.200:41344Thu Dec 29 09:50:14 2016 admin/101.14.19.200:41344 MULTI_sva: pool returned IPv4=192.168.10.6, IPv6=(Not enabled)Thu Dec 29 09:50:16 2016 admin/101.14.19.200:41344 send_push_reply(): safe_cap=940
    
```

Export Log Clear Log Refresh

**Client Status**

```

OpenVPN STATISTICSUpdated,Thu Dec 29 09:52:49 2016TUN/TAP read bytes,0TUN/TAP write bytes,0TCP/UDP read bytes,3170TCP/UDP write bytes,1810Auth read bytes,192pre-compress bytes,0post-compress bytes,0pre-decompress bytes,0post-decompress bytes,0END
    
```

Export Status Log Refresh

**Client Logs**

```

Thu Dec 29 09:50:09 2016 OpenVPN 2.3.10 mips-be-linux-gnu [SSL (OpenSSL)] [LZO] [EPOLL] [MH] [IPv6] built on Dec 23 2016Thu Dec 29 09:50:09 2016 library versions: OpenSSL 1.0.0d 8 Feb 2011, LZO 2.09Thu Dec 29 09:50:09 2016 WARNING: file '/var/ovpn/ovpncli/ovpnclient1.secret' is group or others accessibleThu Dec 29 09:50:09 2016 NOTE: the current --script-security setting may allow this configuration to call user-defined scriptsThu Dec 29 09:50:09 2016 Socket Buffers: R=[114688->114688] S=[114688->114688]Thu Dec 29 09:50:09 2016 UDPv4 link local: [undef]Thu Dec 29 09:50:09 2016 UDPv4 link remote: [AF_INET]42.68.153.20:11943Thu Dec 29 09:50:12 2016 TLS: Initial packet from [AF_INET]42.68.153.20:11943, sid=1ff6915e 7fedf748Thu Dec 29 09:50:12 2016 WARNING: this configuration may cache passwords in memory -- use the auth-nocache option to prevent thisThu Dec 29 09:50:13 2016 VERIFY OK: depth=1, C=TW, ST=Taiwan, L=Taipei, O=MOXA, OU=IW, emailAddress=info@moxa.com, CN=OnCell-G3150A-LTEThu Dec 29 09:50:13 2016 VERIFY OK: nsCertType=SERVERThu Dec 29 09:50:13 2016 VERIFY OK: depth=0, C=TW, ST=Taiwan, O=MOXA, OU=IW, CN=OnCell-G3150A-LTE, emailAddress=info@moxa.comThu Dec 29 09:50:13 2016 Data Channel Encrypt: Cipher 'BF-CBC' initialized with 128 bit keyThu Dec 29 09:50:13 2016 Data Channel Encrypt: Using 160 bit message hash 'SHA1' for HMAC authenticationThu Dec 29
    
```

Export Log Clear Log Refresh

- NOTE**
- *Status:* You can view OpenVPN connection status such as OpenVPN is connected, disconnected and initiating connection and information on the client’s access to the server in the server logs.
  - *Logs:* The Logs show more detailed information than the Status and provide engineers with information for review and trouble shooting. Additional information includes negotiation process, key exchange, and error recordings.

## DNS Status

The **DNS Status** screen displays the DNS server to which the OnCell 3120-LTE-1 is connected and the DNS server information.

Go to DNS Status for DNS server settings information designated at General Setup > Network Settings.

It shows OnCell 3120-LTE-1’s DNS assigned by DNS server and Server 3/4 is stand for Primary DNS and Secondary DNS information at General Setup > Network Settings

DNS Status	
<input checked="" type="checkbox"/> Auto Update	
No	DNS Server
DNS server 1	
DNS server 2	
DNS server 3	
DNS server 4	

## SIM Status

The **SIM Status** screen displays the current SIM card in use and the status of the SIM cards installed in the OnCell 3120-LTE-1.

SIM Status	
SIM	Information
Used SIM	SIM 1
SIM 1	Wrong PIN code or SIM absent
SIM 2	Not in-use

## DHCP Client List

The DHCP Client List shows all the clients that require and have successfully received IP assignments. You can click the **Refresh** button to refresh the list.

DHCP Client List	
MAC	IP
1. 00:13:ce:e1:ee:ef	192.168.127.2

Select all Refresh

You can press **Select all** button to select all content in the list for further editing.

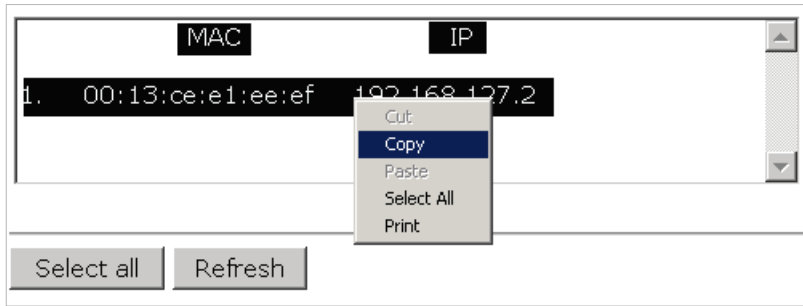

## System Log

Triggered events are recorded in the System Log. You can filter the log contents by time and event type. The log contents can be exported to the local machine, or to an ABC-02 by clicking **Export Log** or **Export to ABC-02** respectively. You can use the **Clear Log** button to clear the log contents and the **Refresh** button to refresh the log.

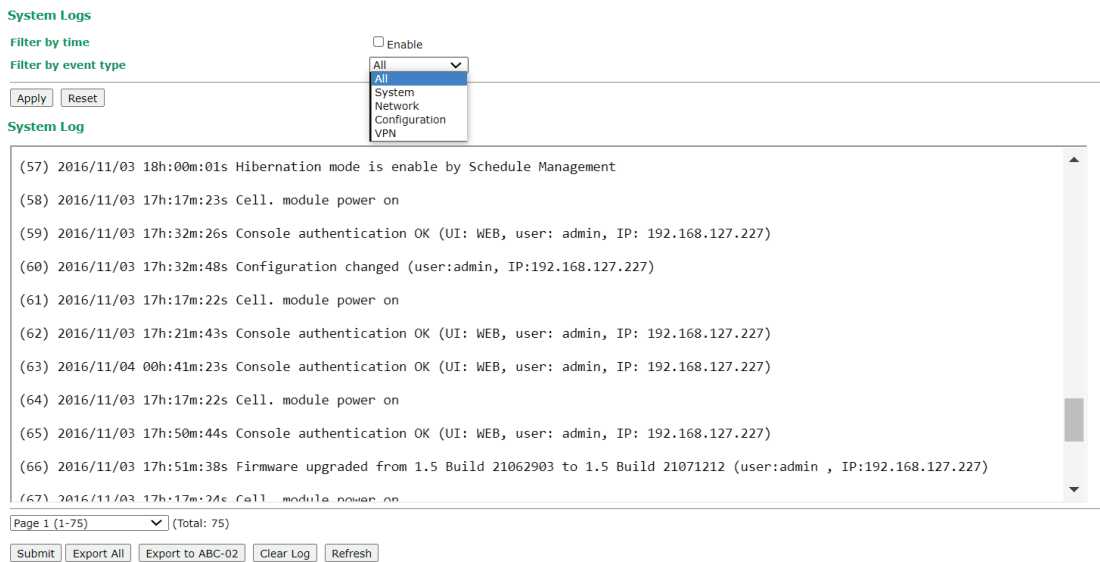

## LAN Status

The **LAN Status** screen displays the LAN port information of the device.

### LAN Status

Auto refresh

LAN No	Speed	Duplex	Link Status	Tx Packets	Rx Packets
LAN 1	100M	FULL	ON	19668	16477
LAN 2	N/A	N/A	OFF	0	0

## System Status

The **System Status** screen displays the OnCell 3120-LTE-1 internal memory capacity status and CPU load information.

**System Status**

Memory Info		
Total	(kB)	126472
Used	(kB)	32828
Free	(kB)	93644

CPU Info	
Usage	(%) 0.04

## Network Status

### Network Statistics

The **Network Statistics** screen displays information on the network interfaces of the device and protocols used along with the packets received and transmitted.

**Network Statistics**

Auto Update

Interface	Actions	Packets Amount	Actions	Packet Amount
LAN1	Received	17849	Sent	21583
LAN2	Received	0	Sent	0
CWAN	Received	0	Sent	0

Protocol	Actions	Packets Amount	Actions	Packet Amount
IP	Received	23381	Sent	26883
	RDiscard	0	SDiscard	0
	ErrHeader	0	ErrAddr	0
	SNoRoute	1		
	ErrProto	0		
	Received	2496	Sent	2496
ICMP	REchoReq	0	SEchoReq	0
	REchoRply	0	SEchoRply	0
	Received	0	Sent	2496
UDP	ErrHeader	0		
	ErrPorts	2496		
TCP	Received	17951	Sent	21891
	ErrHeader	0	ReSent	0
	CurrEstab	1		
	ErrPorts	333		
	Opens	333		

The network statistic parameters and values are described in the following tables:

Interface	Action	Description
LAN	Received	The number of packets the device received through the LAN interface
	Sent	The number of packets the device sent through the LAN interface
CWAN	Received	The number of packets the device received through the CWAN interface
	Sent	The number of packets the device sent through the CWAN interface

Protocol	Actions	Description
IP	Received	The total number of input IP datagram packets that the device received from all interfaces
	Sent	The total number of output IP datagram packets that the device sent from all interfaces
	RDiscard	The input IP datagram packets discarded for various reasons (e.g.: Lack of buffer space)
	SDiscard	The output IP datagram packets discarded for various reasons (e.g.: Lack of buffer space)
	ErrAddr	The input IP datagram packets received with invalid IP addresses
	Errproto	The input IP datagram packets received with incorrect protocol. (i.e., a protocol other than TCP, UDP, and ICMP)

Protocol	Actions	Description
	ErrHeader	The input IP datagram packets received with invalid headers. e.g., bad checksum, version number mismatch, and time-to-live period exceeded)
	SNoRoute	The input IP datagram packets received with incorrect routes
ICMP	Received	The total number of ICMP messages that the device received
	Sent	The total number of ICMP messages that the device sent
	REchoReq	The ICMP request packets that the device received. (e.g., Ping requests received)
	REchoRply	The ICMP reply packets that the device received. (e.g., Ping replies received)
	SEchoReq	The ICMP request packets that the device sent. (e.g., Ping requests sent)
	SEchoRply	The ICMP reply packets that the device received. (e.g., Ping replies received )
UDP	Received	The total number of input UDP datagram packets received by the device
	Sent	The total number of output UDP datagram packets received by the device
	ErrHeader	The input UDP datagram packets received with invalid headers
	ErrPorts	The input UDP datagram packets received with incorrect port numbers

Protocol	Actions	Description
TCP	Received	The total number of input TCP segment packets received by the device
	Sent	The total number of output TCP segment packets received by the device
	ErrHeader	The input TCP segment packets received with invalid headers. (e.g., bad checksum)
	ErrPorts	The input TCP segment packets received with the wrong port number
	ReSent	The output TCP segment packets retransmitted
	CurrEstab	The number of TCP connections established (e.g. status is ESTABLISHED or CLOSE-WAIT)
	Opens	The number of TCP connections to be opened (e.g. status is SYNC-sent, SYNCRCBD, SYNC_RCVD)

## ARP Table

The ARP table is for maintenance people to ping the destination device and get the destination MAC address so as to clarify the connection issue.

ARP Table	
IP Address	Mac Address
192.168.127.3	6C:C2:17:7D:6D:DA

Refresh

## LLDP

The LLDP displays the information of the device that connected to OnCell 3120-LTE-1.

LLDP Status					
Interface	Neighbor Information				
	System Name	ID	IP	Port	Port Description
Refresh					

Field	Description	Default setting
<b>Interface</b>	The device physical internet interface, such as Wi-Fi, Cellular and Ethernet port.	Interface
<b>System Name</b>	A user-defined device system name.	System Name
<b>ID</b>	A user-defined device ID.	ID
<b>IP</b>	The device IP address	IP
<b>Port</b>	The open port that connect at device to OnCell 3120-LTE-1	Port

Field	Description	Default setting
Port Description	The open port description that user given.	Port Description

## Routing Table

The **Routing Table** screen displays the list of routes the OnCell 3120-LTE-1 uses to send packets on each interface.

Routing Table							
<input checked="" type="checkbox"/> Auto refresh							
Destination	Gateway	Netmask	Flags	Metric	Ref	Use	Iface
192.168.128.0	0.0.0.0	255.255.255.0	U	0	0	0	WLAN
192.168.127.0	0.0.0.0	255.255.255.0	U	0	0	0	LAN
169.254.0.0	0.0.0.0	255.255.0.0	U	0	0	0	WLAN
0.0.0.0	192.168.128.253	0.0.0.0	UG	0	0	0	WLAN

Possible flags include:

U: route is up                      +: default gateway  
D: route is down                    T: static route  
G: use gateway                      H: target is a host



# Maintenance

Maintenance functions provide the administrator with tools to manage the OnCell 3120-LTE-1 and wired/wireless networks.

## Console Settings

### Console Settings

**Console Settings**

Auto logout period  (1 to 60 minutes)

**Accessible Interfaces**

Interface	HTTP	HTTPS	Telnet	SSH	SNMP	Moxa Service
Enable services	<input type="checkbox"/>	<input checked="" type="checkbox"/>	<input type="checkbox"/>	<input checked="" type="checkbox"/>	<input type="checkbox"/>	<input checked="" type="checkbox"/>
Ethernet	<input checked="" type="checkbox"/>	<input checked="" type="checkbox"/>	<input type="checkbox"/>	<input checked="" type="checkbox"/>	<input type="checkbox"/>	<input checked="" type="checkbox"/>
C-WAN	<input checked="" type="checkbox"/>	<input checked="" type="checkbox"/>	<input type="checkbox"/>	<input checked="" type="checkbox"/>	<input type="checkbox"/>	<input checked="" type="checkbox"/>

\* If you disable all access portals, you will not be able to remotely access this device.  
 \* If you disable HTTPS, some Moxa service features will be disabled.

Field	Description	Default setting
<b>Auto logout period</b>	Enter the time period (1-60 minutes) that the OnCell 3120-LTE-1 will wait before terminating the connection to the console.	10
<b>Enable service</b>	You can enable or disable connections to the device through HTTP, HTTPS, Telnet, SSH, SNMP, or Moxa services such as OnCell Central Manager.	HTTPS, SSH, Moxa Service
<b>Ethernet</b>	You can enable or disable connections from Ethernet ports to the device through HTTP, HTTPS, Telnet, SSH, SNMP, or Moxa Moxa services such as OnCell Central Manager.	HTTPS, SSH, Moxa Service
<b>C-WAN</b>	You can enable or disable cellular connections to the device through HTTP, HTTPS, Telnet, SSH, SNMP, or Moxa Moxa Service such as OnCell Central Manager.	HTTPS, SSH, Moxa Service

### Accessible Interfaces

**Accessible net list**

Enable  Disable

**Policy**

Accept

No.	Active	Source IP	Source Netmask
1	<input type="checkbox"/>	<input type="text"/>	<input type="text"/>
2	<input type="checkbox"/>	<input type="text"/>	<input type="text"/>
3	<input type="checkbox"/>	<input type="text"/>	<input type="text"/>
4	<input type="checkbox"/>	<input type="text"/>	<input type="text"/>
5	<input type="checkbox"/>	<input type="text"/>	<input type="text"/>
6	<input type="checkbox"/>	<input type="text"/>	<input type="text"/>
7	<input type="checkbox"/>	<input type="text"/>	<input type="text"/>
8	<input type="checkbox"/>	<input type="text"/>	<input type="text"/>

Submit

Field	Description	Default setting
<b>Accessible net list</b>	Enable or disable access permissions to the device.	Disable
<b>Policy</b>	<b>Accept:</b> Only IP addresses on the list are allowed to access to the device. <b>Deny:</b> IP addresses on the list are not allowed to access to the device.	Accept
<b>Active</b>	Active the access policy for the corresponding IP address.	None
<b>Source IP</b>	Enter the IP address(es) to allow or deny access to the device.	N/A
<b>Source Netmask</b>	Enter the netmask of the IP to allow or deny access to the device.	N/A

## SSL Certificate (for HTTPS Only)

### SSL Certificate (For HTTPS only)

Enable  Disable

Import SSL certificate file (PKCS12)

SSL certificate passphrase

Field	Description	Default setting
<b>SSL certificate enable</b>	Enable or disable SSL certificates for HTTPS connections.	Disable
<b>Import SSL certificate file (PKCS12)</b>	Click <b>Browse...</b> to select a local certificate file to import. The certificate must be in the PKCS#12 format.	N/A
<b>SSL certificate passphrase</b>	Enter the passphrase to protect certificate key files.	N/A

## Ping Command

**Ping** helps to diagnose the integrity of wired or wireless networks. By inputting a node’s IP address in the **Destination** field, you can use the **ping** command to make sure it exists and whether or not the access path is available.

**Ping**

Destination

If the node and access path are available, you will see that all packets were successfully transmitted with no loss. Otherwise, some, or even all, packets may get lost, as shown in the following figure.

**Ping**

Destination

---

PING 192.168.127.2 (192.168.127.2): 56 data bytes

--- 192.168.127.2 ping statistics ---

4 packets transmitted, 0 packets received, 100% packet loss

## Firmware Upgrade

The OnCell 3120-LTE-1 can be enhanced with more value-added functions by installing firmware upgrades. The latest firmware is available at Moxa’s download center.

Before running a firmware upgrade, make sure the OnCell 3120-LTE-1 is off-line. Click the **Browse** button to specify the firmware image file and click **Firmware Upgrade and Restart** to start the firmware upgrade. After the progress bar reaches 100%, the OnCell 3120-LTE-1 will reboot itself.

When upgrading your firmware, the OnCell 3120-LTE-1’s other functions will not be accessible.

**Firmware Upgrade**

Select a firmware file  No file chosen

---

Select a firmware file from ABC-02

**ATTENTION**

Please make sure the power source is stable when you upgrade your firmware. An unexpected power disruption may damage your OnCell 3120-LTE-1.

**ATTENTION**

Please note that the firmware of different model revisions might be not compatible with other models. Check the "Applicable Products" section in the firmware release notes before upgrading firmware.

## Configuration Import & Export

You can use the Config Import Export screen to back up or restore the following:

- Configuration settings on the OnCell 3120-LTE-1
- ABC-02 configuration
- MIB

In the **Config Import** section, click **Choose File** to select a configuration file and click **Config Import** button to begin importing configuration. The password is up to 31 characters.

To save the configuration file to a storage media, click **Config Export**. The configuration file is a text file and you can view and edit it with a general text-editing tool.

For MIBs, click **MIB Export** to save the MIB file to a storage media. The configuration file is a **.my** file and you can import using a general SNMP tool and use to remotely control or configure the OnCell 3120-LTE-1.

**ATTENTION**

Please note that the firmware of different model revisions might be not compatible with other models. Make sure to only export and import configuration settings to models with the same model revision and firmware version.

**Configuration Import & Export**

Encryption of import/export configuration

 Enable  Disable

Password

**Configuration Import**

Select a configuration file

 **Configuration Export****ABC-02 Configuration Import****ABC-02 Configuration Export****ABC-02 Automatic Settings**

Auto load configuration from ABC-02 during boot up

 Enable  Disable

Auto backup to ABC-02 when configuration changes

 Enable  Disable

Auto backup system log to prevent overwrites

 Enable  Disable**SNMP MIB File Export**

To download the configuration to the OnCell 3120-LTE-1, complete the following steps:

1. Turn off the OnCell 3120-LTE-1.
2. Connect ABC-02 to the OnCell 3120-LTE-1's USB console.
3. Turn on the OnCell 3120-LTE-1.
4. The OnCell 3120-LTE-1 detects ABC-02 during the boot up process and automatically downloads the configuration from ABC-02. After the configuration is downloaded and if the configuration format is correct, the OnCell 3120-LTE-1 emits three short beeps before continuing the boot up process.
5. After the boot up process is complete, the OnCell 3120-LTE-1 emits two beeps, and the **SYS** LED turns solid green.

## Load Factory Default

Use this function to reset the OnCell 3120-LTE-1 and roll all settings back to the factory default values. You can also reset the hardware by pressing the reset button on the top panel of the OnCell 3120-LTE-1.

**Load Factory Default**

**Reset to Factory Default Values**

Click "**System Reset**" to reset all system settings, including the console password, to factory default values. The system will be restarted immediately after the reset to factory default values.

## Account Settings

To ensure that devices located at remote sites are secure from hackers, we recommend setting up a high-strength password the first time you configure the device.

**Password Policy**

**Minimum password length**  (4 - 16 characters)  
**Password strength check**   
**Password validity**  (0 - 365 days, 0 is disable)  
**Password retry count**  (0 - 10, 0 is disable)  
**Lockout time**  (60 - 3600 seconds)

**Account List**

No.	Active	Account Name	User Level	HTTP/HTTPS	Telnet/SSH /Console	Moxa Services	Diagnostics	Action	
1	<input checked="" type="checkbox"/>	admin	Admin	<input checked="" type="checkbox"/>	<input checked="" type="checkbox"/>	<input checked="" type="checkbox"/>	<input checked="" type="checkbox"/>	<input type="button" value="Edit"/>	<input type="button" value="Delete"/>
2	<input type="checkbox"/>		Admin	<input checked="" type="checkbox"/>	<input checked="" type="checkbox"/>	<input checked="" type="checkbox"/>	<input checked="" type="checkbox"/>	<input type="button" value="Edit"/>	<input type="button" value="Delete"/>
3	<input type="checkbox"/>		Admin User	<input checked="" type="checkbox"/>	<input checked="" type="checkbox"/>	<input checked="" type="checkbox"/>	<input checked="" type="checkbox"/>	<input type="button" value="Edit"/>	<input type="button" value="Delete"/>
4	<input type="checkbox"/>		Admin	<input checked="" type="checkbox"/>	<input checked="" type="checkbox"/>	<input checked="" type="checkbox"/>	<input checked="" type="checkbox"/>	<input type="button" value="Edit"/>	<input type="button" value="Delete"/>
5	<input type="checkbox"/>		Admin	<input checked="" type="checkbox"/>	<input checked="" type="checkbox"/>	<input checked="" type="checkbox"/>	<input checked="" type="checkbox"/>	<input type="button" value="Edit"/>	<input type="button" value="Delete"/>
6	<input type="checkbox"/>		Admin	<input checked="" type="checkbox"/>	<input checked="" type="checkbox"/>	<input checked="" type="checkbox"/>	<input checked="" type="checkbox"/>	<input type="button" value="Edit"/>	<input type="button" value="Delete"/>
7	<input type="checkbox"/>		Admin	<input checked="" type="checkbox"/>	<input checked="" type="checkbox"/>	<input checked="" type="checkbox"/>	<input checked="" type="checkbox"/>	<input type="button" value="Edit"/>	<input type="button" value="Delete"/>
8	<input type="checkbox"/>		Admin	<input checked="" type="checkbox"/>	<input checked="" type="checkbox"/>	<input checked="" type="checkbox"/>	<input checked="" type="checkbox"/>	<input type="button" value="Edit"/>	<input type="button" value="Delete"/>

\* Only characters allowed in the Account Name are alphabets, numerals, at sign (@), period (.), and underscore(\_).

Field	Description	Default setting
<b>Minimum password length</b>	By default, passwords can be between 4 and 16 characters. For improved security, we recommend changing the minimum password length to at least 8 characters the first time you configure the device.	4
<b>Password strength check</b>	Enable the password strength check option to ensure that users are required to select high-strength passwords. Note: See the <b>Change Password</b> section below for details.	Disable
<b>Password validity</b>	The number of days after which the password must be changed. Passwords should be updated regularly to protect against hackers.	90 days
<b>Password retry count</b>	The number of consecutive times a user can enter an incorrect password while logging in before the device's login function is locked.	5
<b>Lockout time</b>	The number of seconds the device's login function will be locked after n consecutive unsuccessful login attempts, where n = the password retry count.	600 seconds

Click **Edit** to create a new, or edit an existing, user account. The items shown below can be configured. Note that a maximum of 2 admin-level users can be logged in to the system at the same time.

**Account Settings**

**Active**

**User level**

**Account name**  (A-Z, a-z, 0-9, '@', '.', and '\_')

**New Password**

**Confirm Password**

- Your password must follow the password policy.
- The minimum password length is 4 characters.

**Accessible Access Portal**

**HTTP/HTTPS**  Enable  Disable

**Telnet/SSH/Console**  Enable  Disable

**Moxa Service**  Enable  Disable

**Diagnostic**  Enable  Disable

Field	Description	Default Setting
<b>Active</b>	Select Enable to enable the user account.	Disable
<b>User level</b>	Administrator: Allows the user to access the Web UI, change the device's configuration, and use the device's import/export capability. User: Allows the user to access the Web UI, but the user will not be able to change the device's configuration or use the device's import/export capability.	Admin
<b>Account name</b>	The username of the account.	N/A
<b>New Password</b>	The password used to log in to the device.	N/A
<b>Confirm Password</b>	Retype the password. If the Confirm Password and New Password fields do not match, you will be asked to reenter the password.	N/A

## Change Password

Use the **Change Password** function to change the password of existing user accounts. First input the current password, and then type the new password in the **New password** and **Confirm password** input boxes.

**NOTE** To maintain a higher level of network security, do not use the default password (moxa), and be sure to change all user account passwords regularly.

**Change Password**

**Current password**

**New password**

**Confirm password**

- Your password must follow the password policy.
- The minimum password length is 4 characters.

**NOTE** If the **Password-strength test** option is enabled, you will be prompted to use passwords that adhere to the following password policy:

- The password must contain at least one digit: 0, 1, 2, ..., 9.
- The password must contain both upper and lower case letters: A, B, ..., Z, a, b, ..., z.
- The password must contain at least one of the following special characters: ~!@#\$%^&\*\_-\_:.,<>[]
- The password cannot contain the following special characters: ` ' " | ;
- The password must have more characters than the minimum password length (default = 4).

## Locate Device

The **Locate Device** function will help you easily find and identify the OnCell device. Pressing **Start to Locate** will turn on the OnCell device’s beeper and the SYS LED will blink at 1-sec intervals.

### Locate Device (Beeper & LED)

Status: Ready to locate

Start to Locate

## Miscellaneous Settings

Additional settings that help you manage your OnCell 3120-LTE-1 are available on this page.

**Miscellaneous Settings**

**Reset button**     Always enable     Disable factory reset function after 60 seconds.

Select one of the following **Reset button** options:

- **Always enable**–Set the reset button to perform a factory restore on the OnCell 3120-LTE-1. This is the default option.
- **Disable factory reset function after 60 seconds**–Deactivate the factory reset function of the reset button 60 seconds after the OnCell 3120-LTE-1 restarts.

## Troubleshooting

**Troubleshooting**

Export current device information    Export

---

**Diagnostics**

Diagnostic script    Choose File    No file chosen

Export diagnostic results     to a file     to a TFTP server

TFTP sever IP   

Diagnostic script name    N/A

Last start time    N/A

Last end time    N/A

Diagnostic status   

Diagnostic result    N/A

Run Script    Stop Script

Field	Description	Default Setting
<b>Export current device information</b>	Export the current device information including system logs, system status, and configuration files. Provide the exported file to Moxa technical support for troubleshooting.	N/A
<b>Diagnostic script</b>	Moxa technical support will provide a diagnostics script file to retrieve additional system information if necessary. Import the diagnostics script file provided by Moxa technical support and click <b>Run Script</b> to start collecting system information.	N/A
<b>Export diagnostic results</b>	Choose to export the diagnostics results to a local file or to a TFTP server.	to a file
<b>TFTP server IP</b>	If exporting to a TFTP server, enter the IP address of the TFTP server.	N/A
<b>Diagnostic script name</b>	The name of the diagnostics script.	N/A
<b>Last start time</b>	The time the diagnostics script was last started.	N/A
<b>Last end time</b>	The time the diagnostics script last ended.	N/A
<b>Diagnostic status</b>	The status of the system diagnosis when the script is running.	N/A
<b>Diagnostic result</b>	The diagnostics results after the script has finished running.	N/A

## Manual SMS

The manual SMS feature allows you to send text messages through the web console.

In the Manual SMS screen, enter the phone number of the SMS recipient and the message content of your message; then click **Send** to send the text message.

After the SMS is sent, the screen displays the following information:

- The item number
- The time the message was sent
- The destination phone number
- Status of the message—Information on whether the SMS was successfully sent.

**Manual SMS**

**Manual Sending SMS Settings**

**Phone number**

**SMS content (Max. 160 characters)**  
**Characters remaining: 160**

**Note: Special characters such as '^', '\', '|', '~', '!', '}', '{', and '}' require two bytes.**

## Remote SMS Control

In cases where the OnCell 3120-LTE-1 is installed in a location with limited GPRS service, you can use the remote SMS control feature to get the current status of the OnCell 3120-LTE-1 or restart the OnCell 3120-LTE-1.

The **Command** field in the **Remote SMS Control** screen shows the SMS message format.



### Remote SMS Control

Remote SMS control Disable ▼

Configuration

Password

Auth type None ▼

Caller ID 1

Caller ID 2

Caller ID 3

Caller ID 4

Item	Action	Acknowledge	Command
Restart	<input type="checkbox"/>	<input type="checkbox"/>	@password@restart
Cellular report	<input type="checkbox"/>	<input type="checkbox"/>	@password@cell.report
Upgrade firmware remotely	<input type="checkbox"/>	<input type="checkbox"/>	@password@upgrade@URL
Change OCM IP address	<input type="checkbox"/>	<input type="checkbox"/>	@password@ip.change@IP
Start cellular connection	<input type="checkbox"/>	<input type="checkbox"/>	@password@cellular.start
Stop cellular connection	<input type="checkbox"/>	<input type="checkbox"/>	@password@cellular.stop
Start IPsec connection	<input type="checkbox"/>	<input type="checkbox"/>	@password@ipsec.start
Stop IPsec connection	<input type="checkbox"/>	<input type="checkbox"/>	@password@ipsec.stop
Start OpenVPN connection	<input type="checkbox"/>	<input type="checkbox"/>	@password@openvpn.start
Stop OpenVPN connection	<input type="checkbox"/>	<input type="checkbox"/>	@password@openvpn.stop
Enter sleep mode	<input type="checkbox"/>	<input type="checkbox"/>	@password@sleepmode.on
Leave sleep mode	<input type="checkbox"/>	<input type="checkbox"/>	@password@sleepmode.off

Field	Description	Default Setting
<b>Remote SMS Control</b>	Select Enable to activate the remote SMS control feature.	Disable
<b>Password</b>	Enter a password (4 to 16 characters).	N/A
<b>Auth type</b>	To restrict access to the OnCell 3120-LTE-1, select the <b>Caller ID</b> authentication type.	None
<b>Caller ID</b>	If you use the caller ID authentication type, enter the caller ID number that can send SMS control messages to the OnCell 3120-LTE-1.	N/A
<b>Action</b>	Select this check box to perform the SMS control action.	
<b>Acknowledge</b>	Select this check box to send a reply to the SMS sender after the operation is completed.	

For example, if you enter "12345" for the password and send an SMS message with the content "@12345@cell.report" to the OnCell 3120-LTE-1, the OnCell 3120-LTE-1 sends an SMS message with the current status back to the sender.

## Saving the Configuration

The following figure shows how the OnCell 3120-LTE-1 stores the configuration changes into volatile and non-volatile memory. All data stored in volatile memory will be erased when the OnCell 3120-LTE-1 is shutdown or rebooted. Because the OnCell 3120-LTE-1 starts up and initializes with the settings stored in flash memory, all new changes must be saved to the flash memory before restarting the OnCell 3120-LTE-1.

This also means the new changes will not work unless you run either the **Save Configuration** function or the **Restart** function.

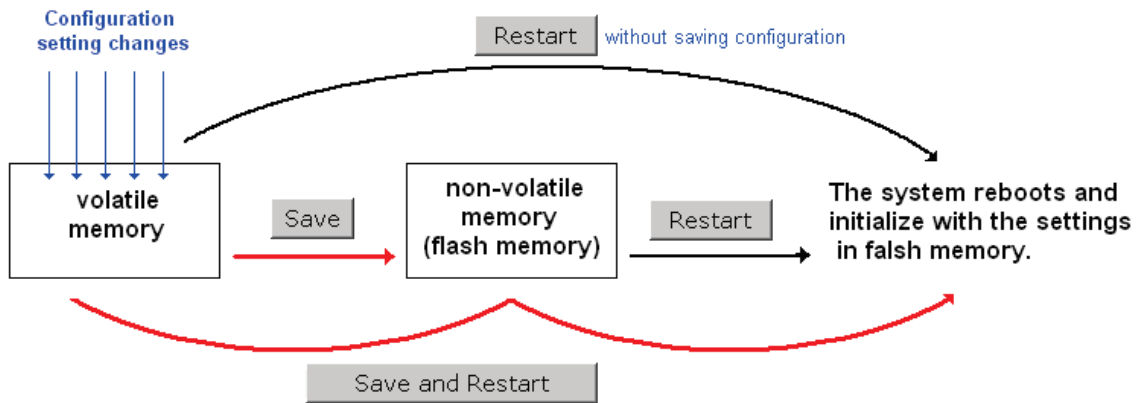

After you click on **Save Configuration** in the left menu box, the following screen will appear. Click **Save** if you wish to update the configuration settings in the flash memory at this time. Alternatively, you may choose to run other functions and put off saving the configuration until later. However, the new changes will remain in the non-volatile memory until you save the configurations.

**Save Configuration**

You must save the changes and restart the system for configuration changes to take effect. Click **Save** to save configuration changes to the system memory.

**Network Settings After Reboot**

Network Info	
LAN IP address	192.168.126.254
LAN subnet mask	255.255.0.0

## Restart

If you submitted configuration changes, you will see a blinking message in the upper right corner of the screen. After making all your changes, click the **Restart** function in the left menu box. One of two different screens will appear.

If you made changes recently but did not save the changes, you will be given two options. Clicking the **Restart** button will reboot the OnCell 3120-LTE-1 directly, and all changes will be ignored. Clicking the **Save and Restart** button will apply all changes before rebooting the OnCell 3120-LTE-1.

**Restart**

!!! Warning !!!

Click **Restart** to discard configuration changes and restart the system.

Click **Save and Restart** to save configuration changes and restart the system.

---

Restart    Save and Restart

---

**Scheduled Restart**

Restart time 1  Enable  
0 : 0 (HH:MM)

Restart time 2  Enable  
0 : 0 (HH:MM)

---

Submit

---

**Network Settings After Reboot**

**Network Info**

<b>LAN IP address</b>	192.168.127.254
<b>LAN subnet mask</b>	255.255.255.0

If you run the **Restart** function without changing any configurations or saving all your changes, you will see just one **Restart** button on your screen.

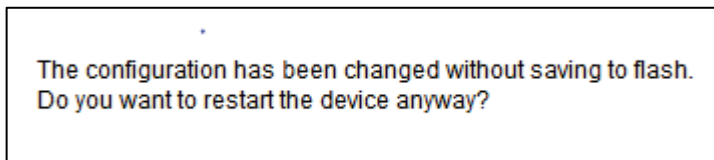

You will not be able to run any of OnCell 3120-LTE-1’s functions while the device is rebooting.

You can use the **Scheduled Restart** function to schedule automatic reboot of the OnCell device by specifying up to two restart times (HH:MM) per day. To set up a scheduled restart, click on the Enable box for the Restart time 1 or 2, enter the time and click **Submit**.

## Logout

**Logout** helps users disconnect the current HTTP or HTTPS session and go to the Login page. For security reasons, we recommend that you logout before quitting the console manager.

**Logout**

Click **Logout** to log out of the web console.

---

Logout

# Software Installation and Configuration

---

The following topics are covered in this chapter:

- **Overview**
- **Wireless Search Utility**
  - Installing the Wireless Search Utility
  - Configuring the Wireless Search Utility

## Overview

The Documentation & Software CD included with your OnCell 3120-LTE-1 is designed to make the installation and configuration procedure easy and straightforward. This auto-run CD includes the Wireless Search Utility (to broadcast search for all OnCell 3120-LTE-1 units accessible over the network), the OnCell 3120-LTE-1 User's Manual, and Quick Installation Guide.

## Wireless Search Utility

### Installing the Wireless Search Utility

Download the executable for the Wireless Search Utility from the Moxa website and run it. In the installation screen, click **Yes** to proceed.

1. In the welcome screen, click **Next** to proceed with the installation.

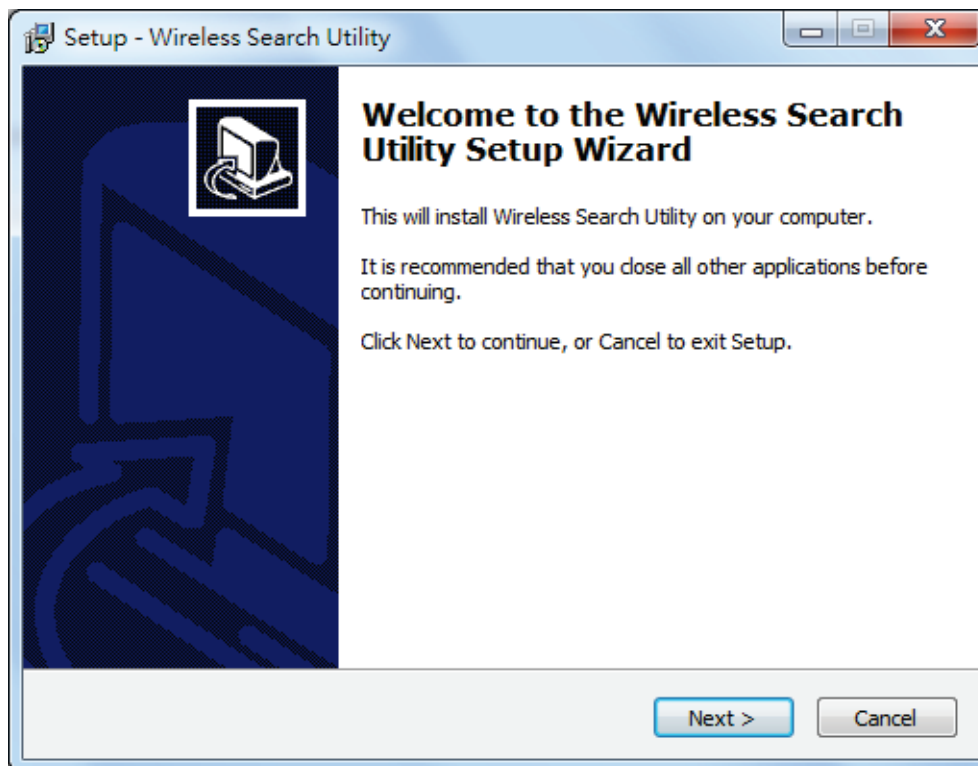

2. Click **Next** to install program files to the default directory, or click **Browse** to select an alternate location.

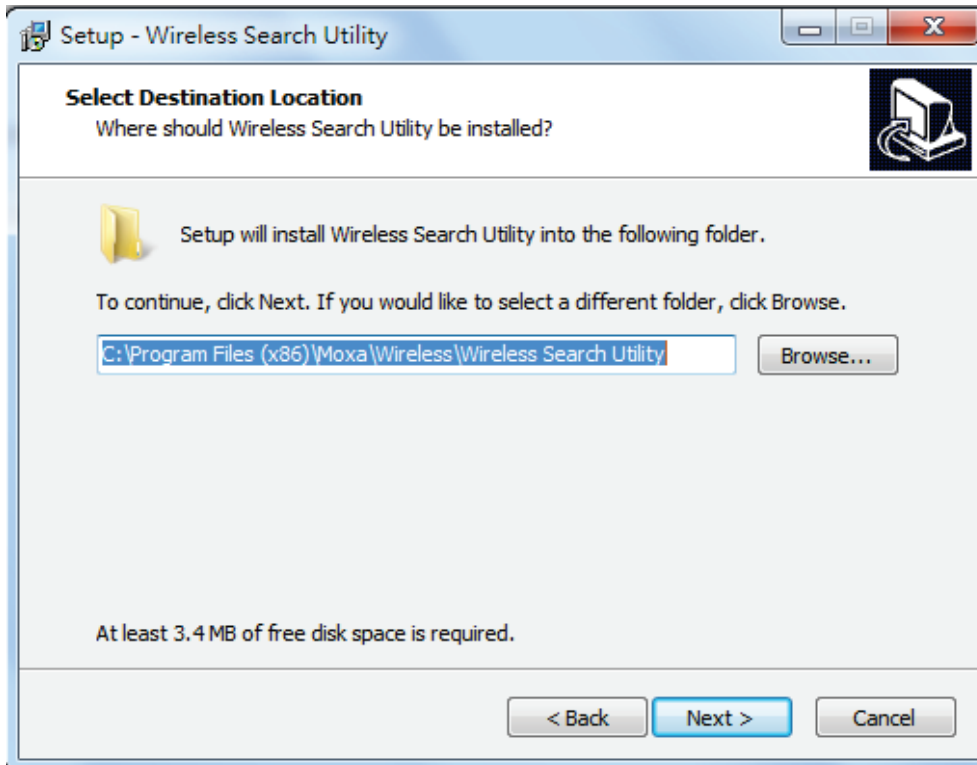

3. Click **Next** to create the program's shortcut files to the default directory, or click **Browse** to select an alternate location.

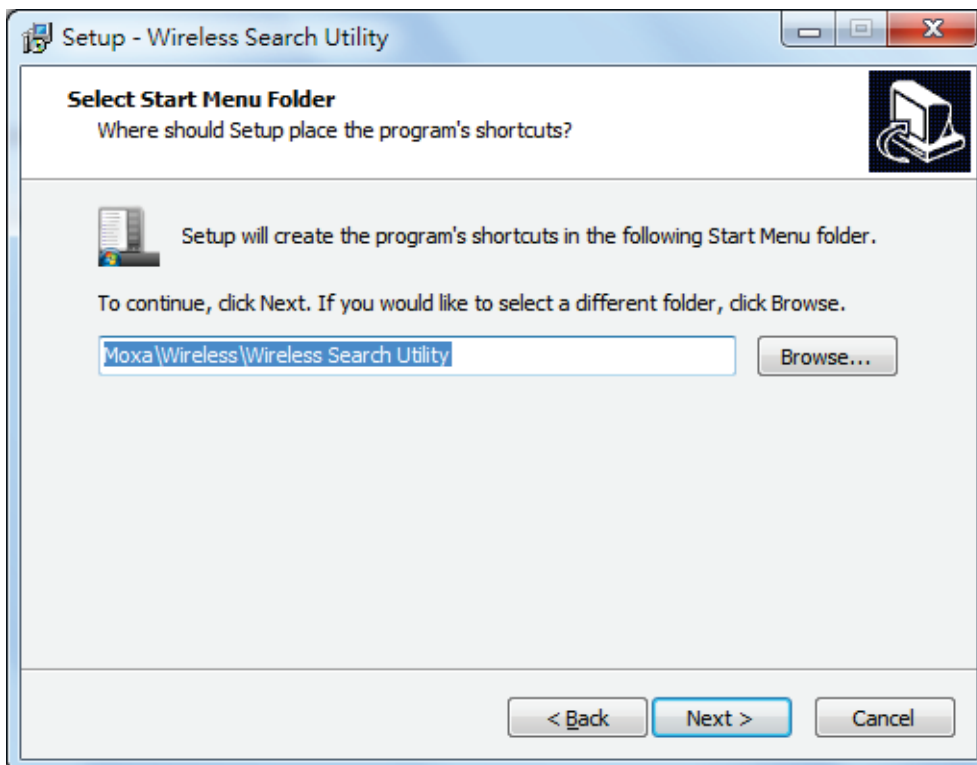

- Click **Next** to select additional tasks.

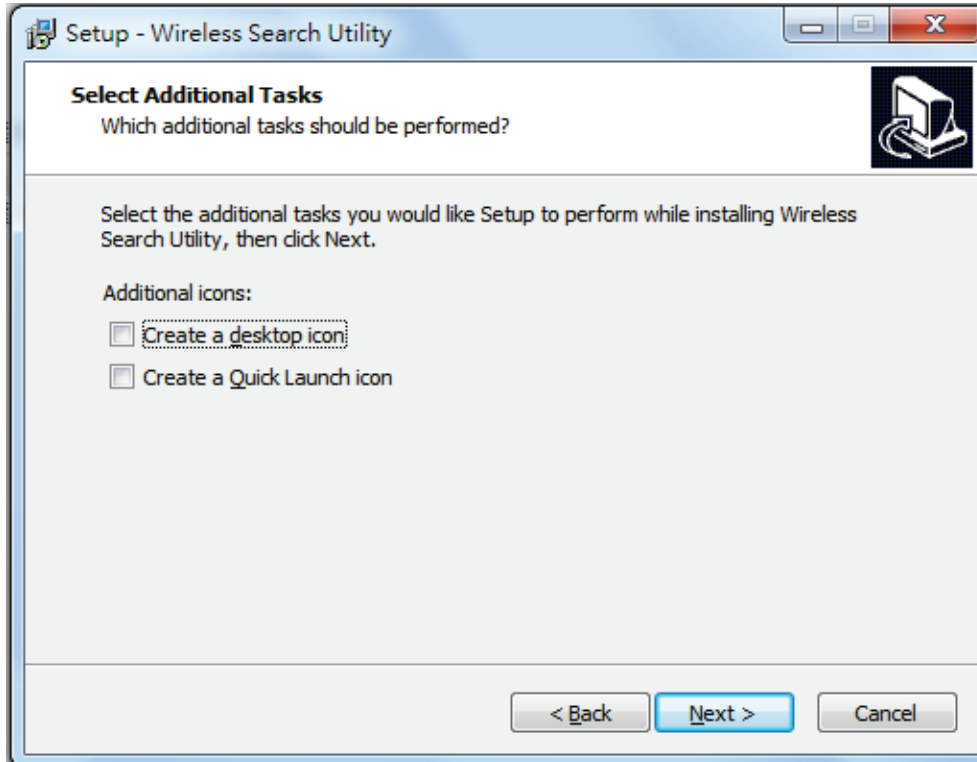

- Click **Next** to proceed with the installation. The installer then displays a summary of the installation options.

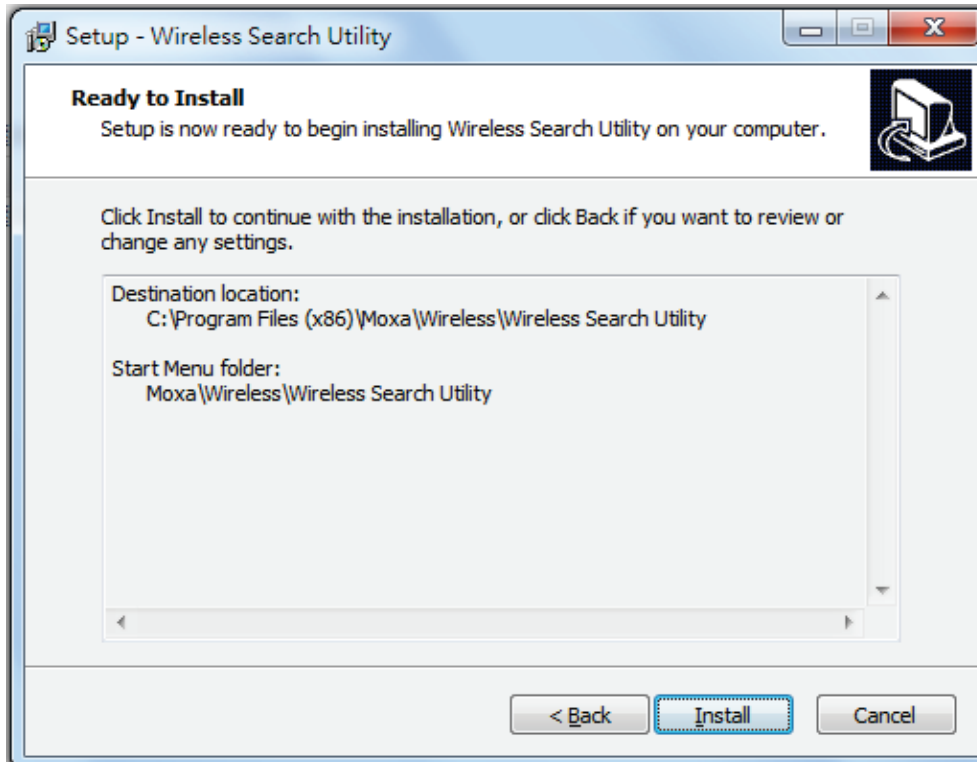

- Click **Install** to begin the installation. The setup window will report the progress of the installation. To change the installation settings, click **Back** and navigate to the previous screen.

7. Click **Finish** to complete the installation of the Wireless Search Utility.

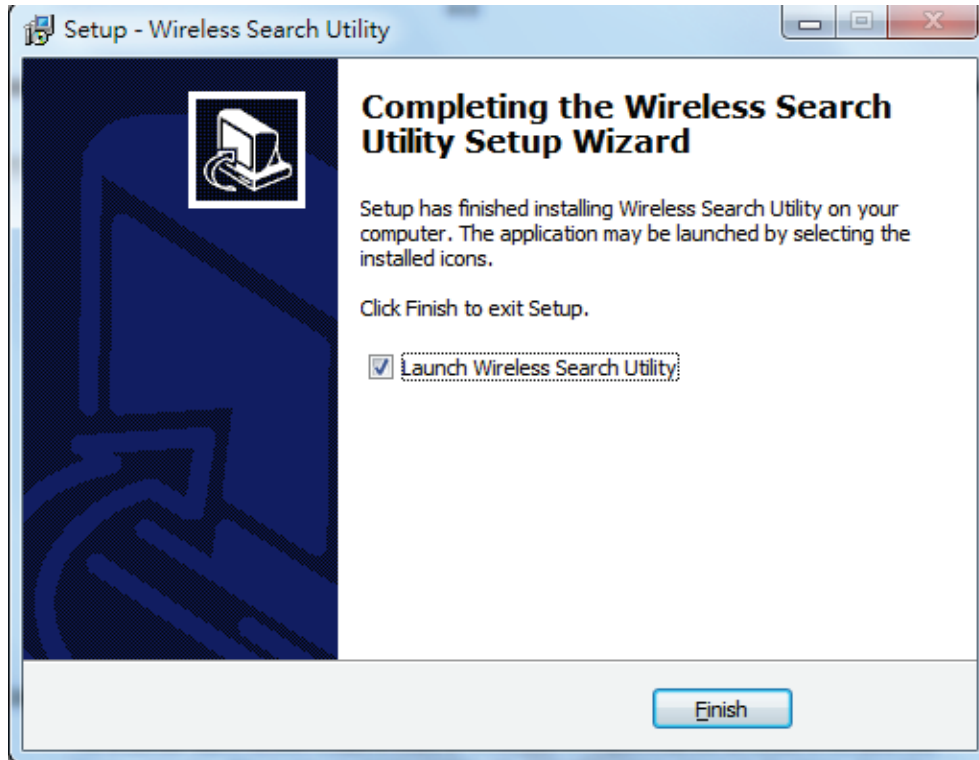

## Configuring the Wireless Search Utility

The Broadcast Search function is used to locate all OnCell 3120-LTE-1 APs that are connected to the same LAN as your computer. After locating an OnCell 3120-LTE-1, you will be able to change its IP address since the Broadcast Search function searches by UDP packet and not IP address.

1. Start the **Wireless Search Utility** program.  
If this is the first time you start the program, you are prompted to set the password (must be longer than four characters).
2. In the Wireless Search Utility screen, choose one of the following options and click OK.
  - **Device search only**—Search for OnCell 3120-LTE-1 units and to view each OnCell 3120-LTE-1's configuration.
  - **Device management**—Assign IP addresses, upgrade firmware, and locate devices.

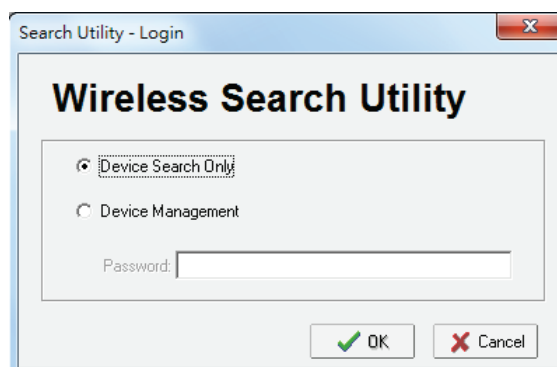

**NOTE** To apply device search and management, ensure your device at factory default setting or remove your SIM card. This is to avoid assigned IP different from default subnet and result in function failure.



3. Click **Search**.

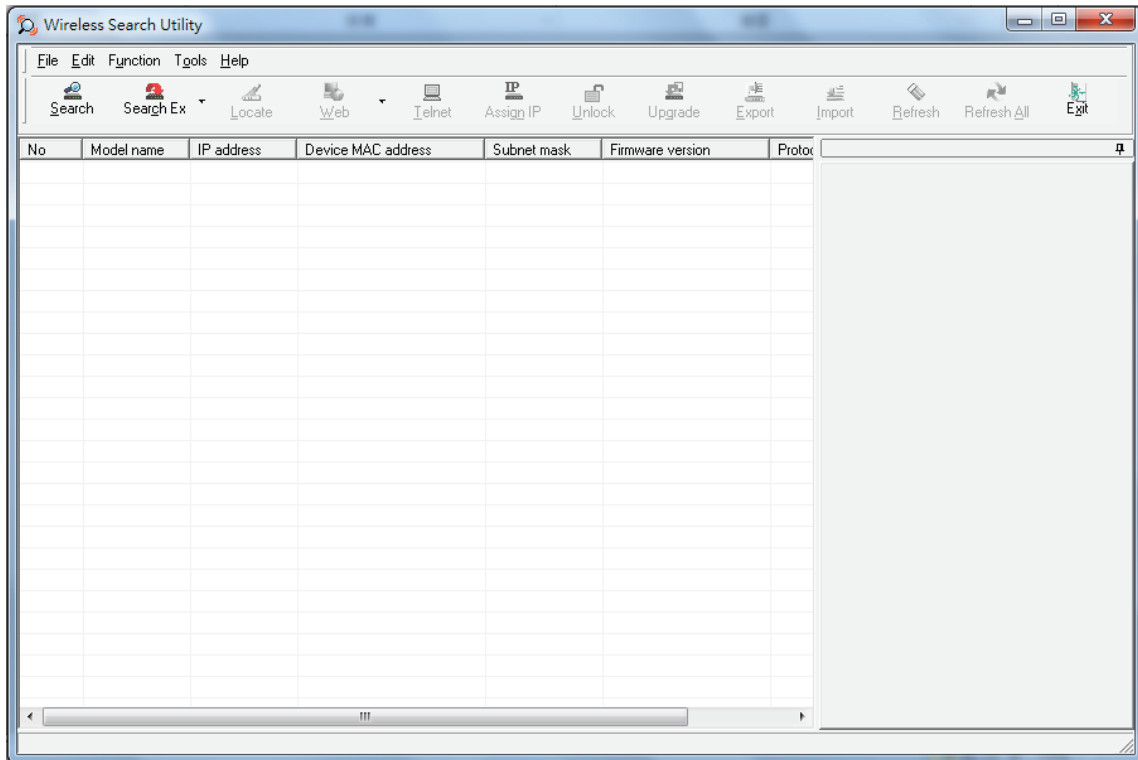

4. The "Searching" window indicates the progress of the search. When the search is complete, all devices that were located will be displayed in the Wireless Search Utility window.

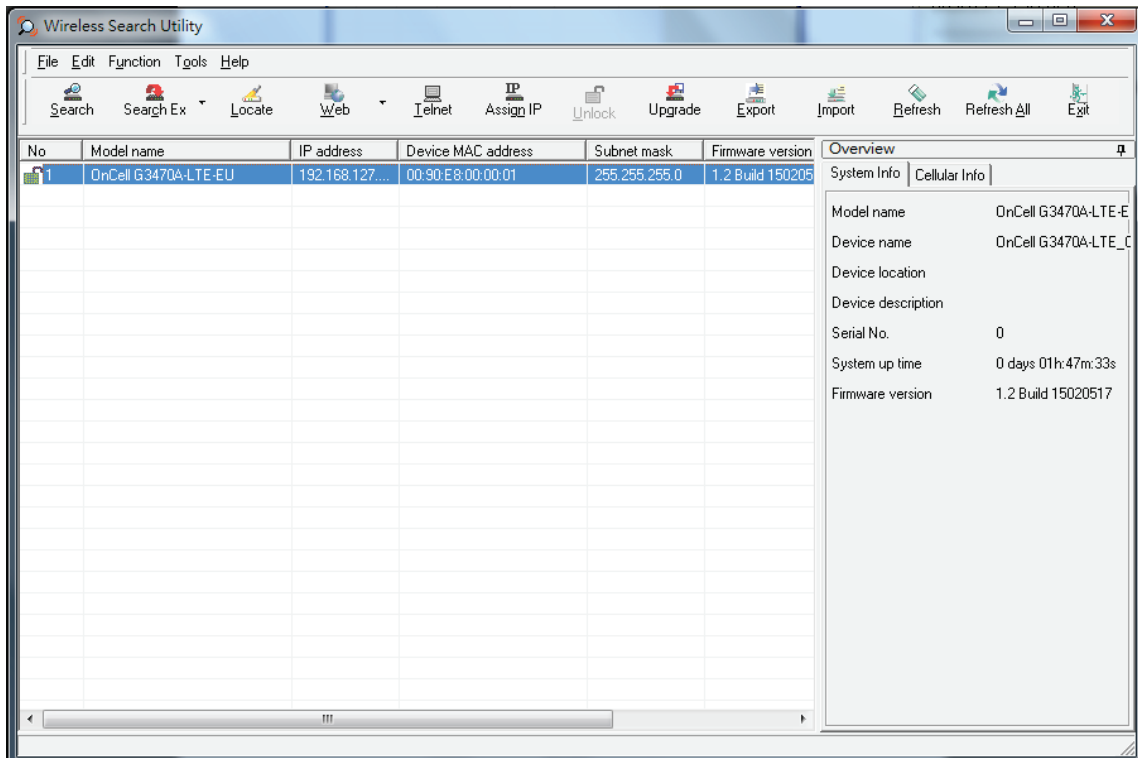

- Click **Locate** to cause the selected device to beep.

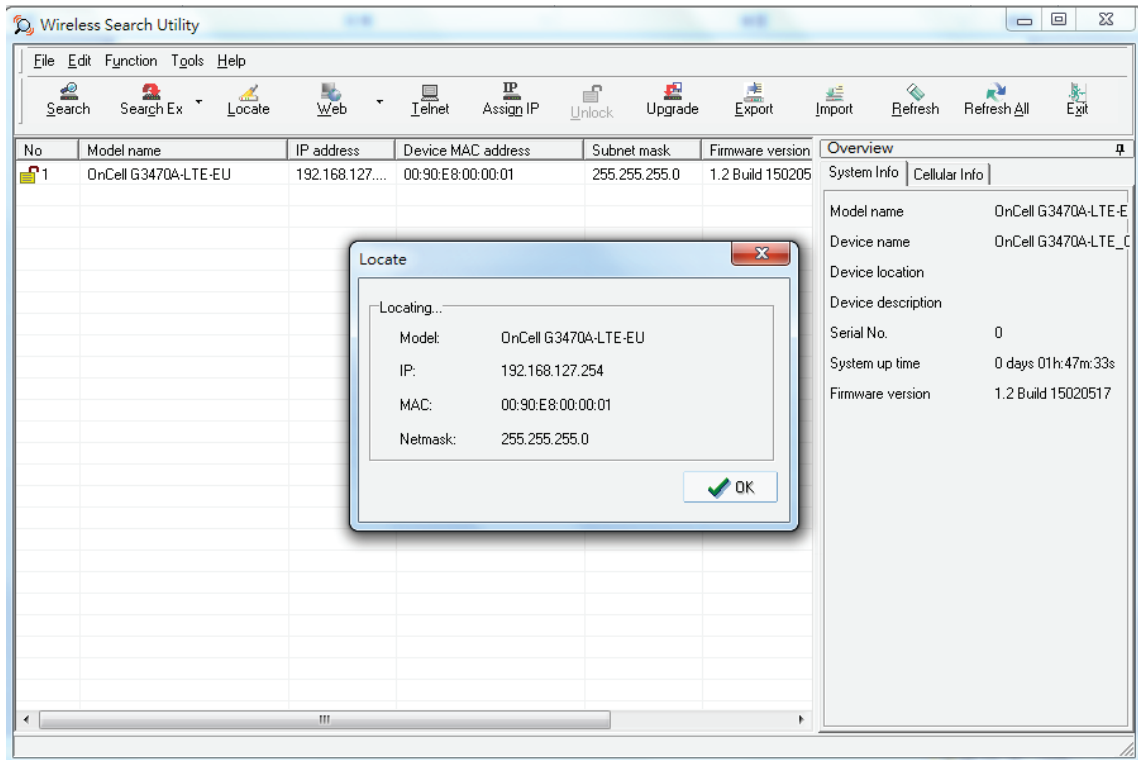

- Make sure that your device is **unlocked** before using the search utility's icons setting. The device will unlock automatically if the password is set to the default. Otherwise you must enter the new password manually.
- Go to **Tools > Device login Options** to manage and unlock additional AWKs.

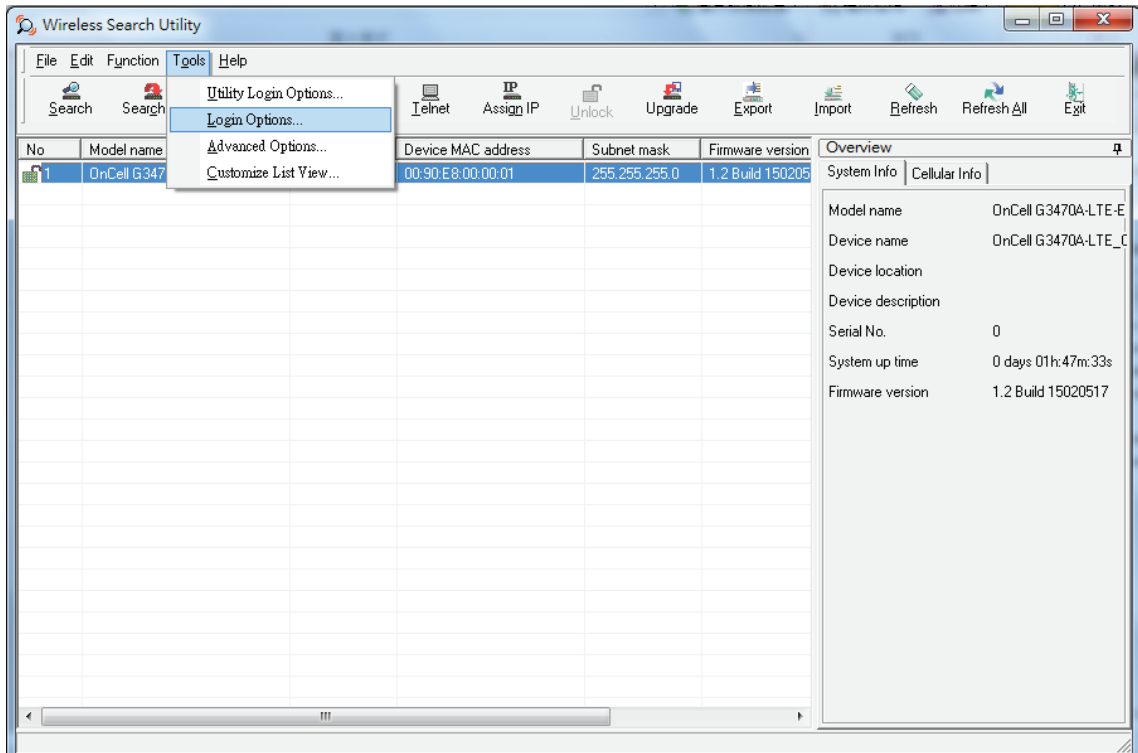

- Use the scroll down list to select the MAC addresses of the devices that you want to manage, and then click **Add**. Key in the password for the device and then click **OK** to save. If you return to the search page and search for the device again, you will find that the device will unlock automatically.

To modify the configuration of the highlighted device, click the **Web** icon to open the web console. This will take you to the web console, where you can make all configuration changes. Refer to Chapter 3, *Using the Web Console*, for information on how to use the web console.

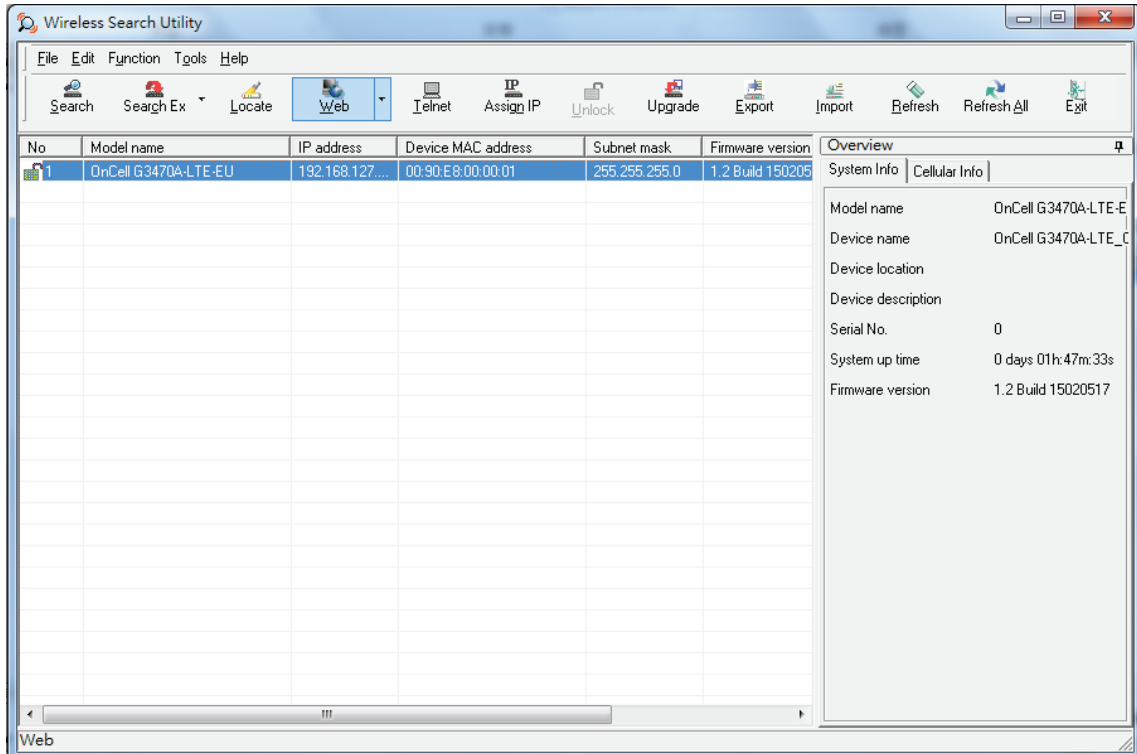

Click **Telnet** if you would like to use telnet to configure your devices.

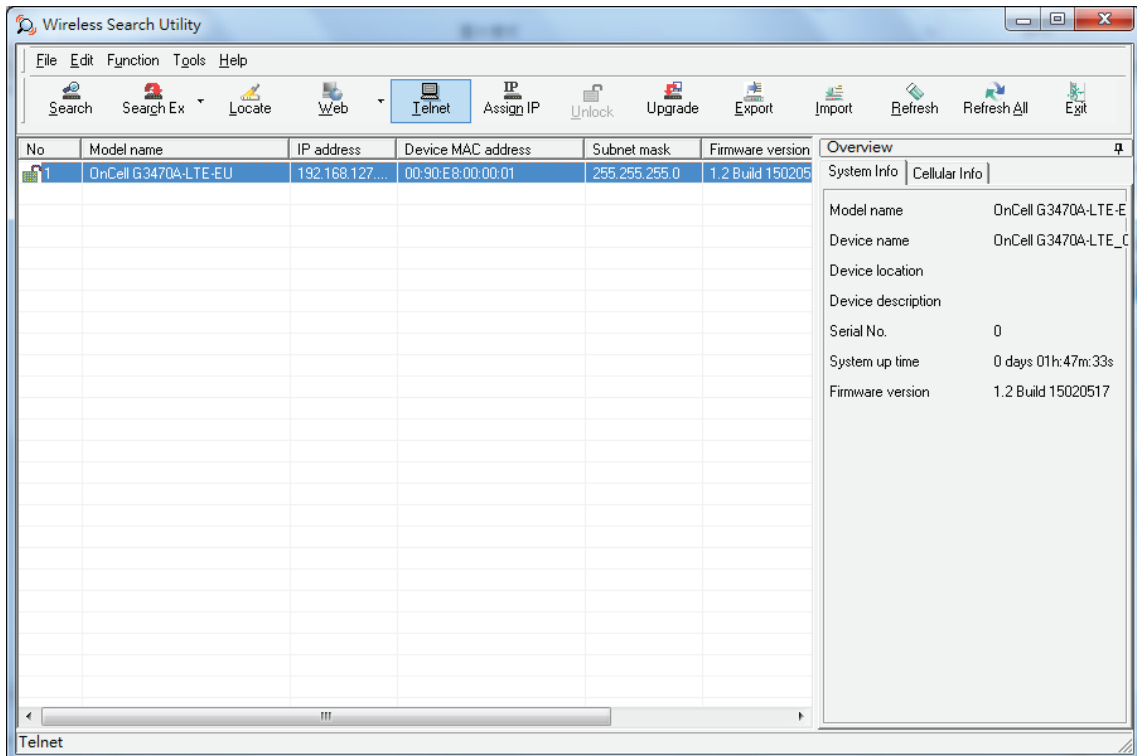

Click **Assign IP** to change the IP setting.

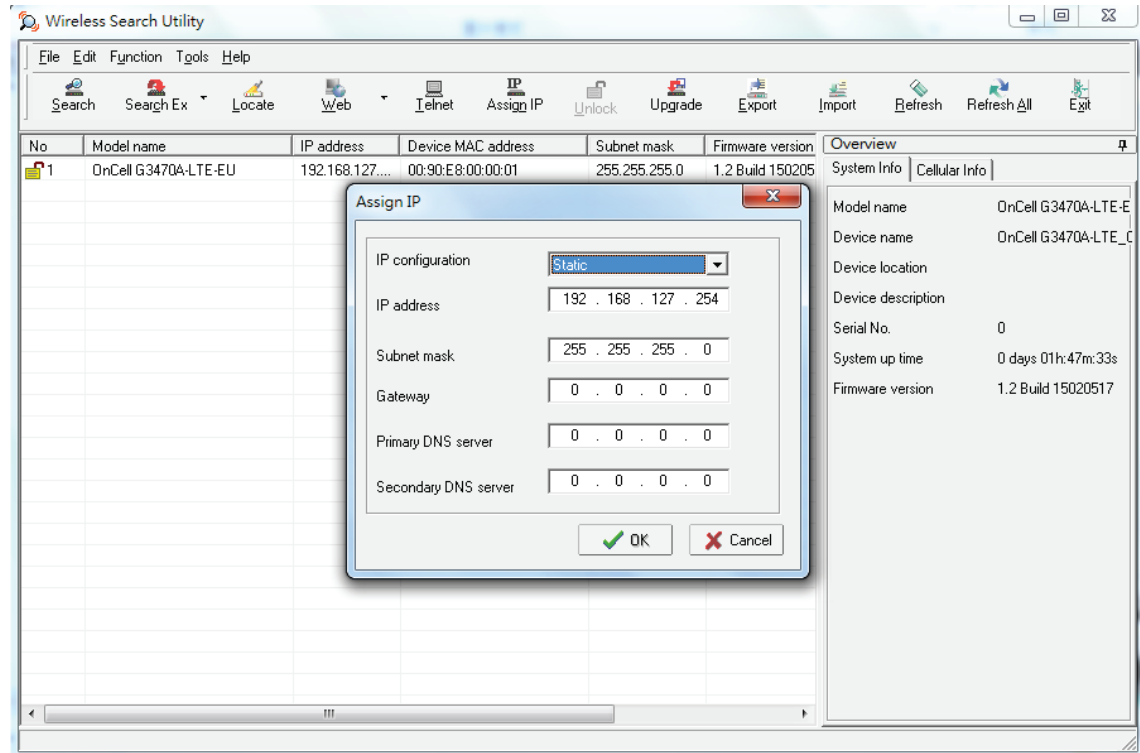

The three advanced options—**Search**, **Connection**, and **Miscellaneous**—are explained below:

### Search

- **Retry count (default=5):** Indicates how many times the search will be retried automatically.
- **Retry interval (ms):** The time to wait between retries.
- **Multicast retry count (default = 3):** Indicates how many times the search will be retried automatically by multicast mode.

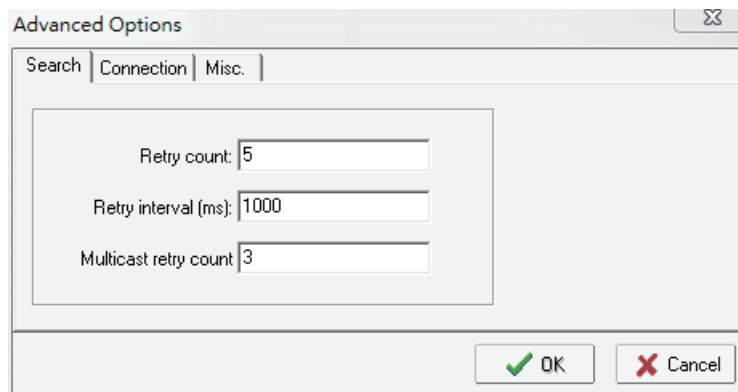

### Connection

- **Connection timeout (secs):** Use this option to set the waiting time for the **Default Login**, **Locate**, **Assign IP**, **Upload Firmware**, and **Unlock** to complete.
- **Upgrade timeout (secs):** Use this option to set the waiting time for the connection to disconnect while the firmware is upgrading. Use this option to set the waiting time for the Firmware to write to flash.
- **Protocol timeout (msec):** Use this option to set the waiting time for package round trip while sending out comments. If no response within 200 msec will recognize connection failed.

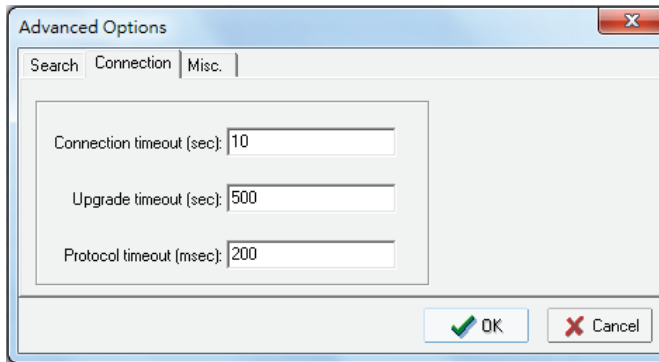

**Misc.**

**Search on start:** Checkmark this box if you would like the search function to start searching for devices after you log in to the Wireless Search Utility.

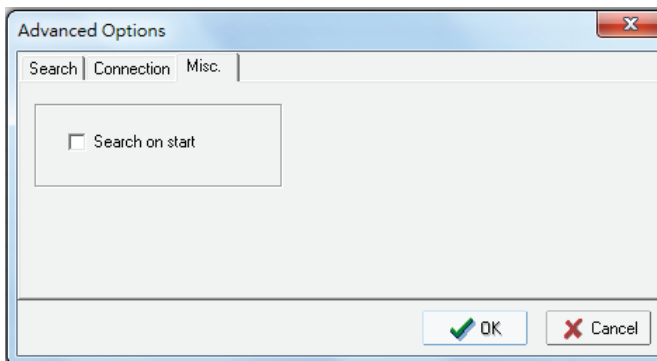

# A

## Supporting Information

---

This chapter presents additional information about this product. You can also learn how to contact Moxa for technical support.

The following topics are covered in this appendix:

- ❑ **Firmware Recovery**
- ❑ **DoC (Declaration of Conformity)**
  - Federal Communication Commission Interference Statement
  - R&TTE Compliance Statement

# Firmware Recovery

When the **SYS** LED turns red, it means the system booting has failed. It may result from some wrong operation or uncontrollable issues, such as an unexpected shutdown during firmware update. The OnCell 3120-LTE-1 is designed to help administrators recover such damage and resume system operation rapidly. You can refer to the following instructions to recover the firmware:

Connect to the OnCell 3120-LTE-1's RS-232 console with 115200bps and N-8-1. You will see the following message shown on the terminal emulator every one second.

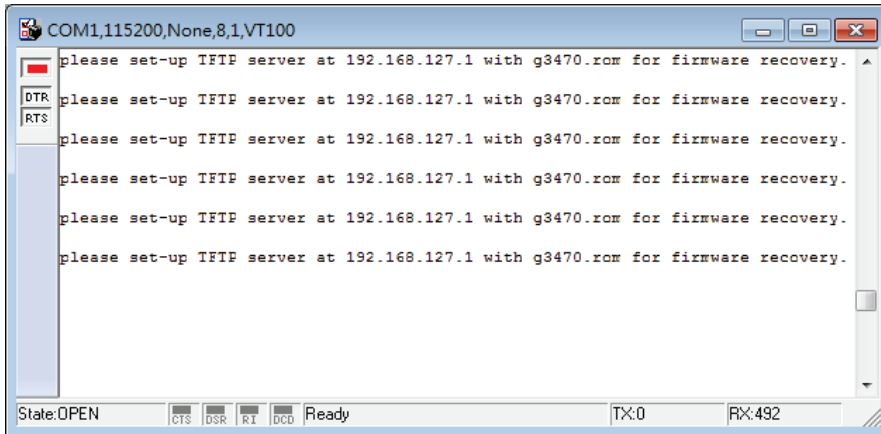

Take the following steps for the firmware recovery:

1. Change the IP address of the laptop to 192.168.127.1.
2. Set up a TFTP sever in your laptop.
3. Download OnCell 3120-LTE-1's firmware from Moxa Website
4. Change firmware file name to OnCell 3120-LTE-1.rom
5. Connect to the OnCell 3120-LTE-1's RJ45 Ethernet port

If setting is correct, you will see the following message shown on the terminal emulator, and the OnCell 3120-LTE-1 will reboot when the firmware recovery process has been finished.

Trying eth0

Using eth0 device

TFTP from server 192.168.127.1; our default IP address is 192.168.127.254

Filename 'OnCell 3120-LTE-1.rom'.

Load address: 0x80060000

Loading:

```
*#####
#####
#####
```

# DoC (Declaration of Conformity)

## Federal Communication Commission Interference Statement

This equipment has been tested and found to comply with the limits for a Class B digital device, pursuant to Part 15 of the FCC Rules. These limits are designed to provide reasonable protection against harmful interference in a residential installation. This equipment generates, uses and can radiate radio frequency energy and, if not installed and used in accordance with the instructions, may cause harmful interference to radio communications. However, there is no guarantee that interference will not occur in a particular installation. If this equipment does cause harmful interference to radio or television reception, which can be determined by turning the equipment off and on, the user is encouraged to try to correct the interference by one of the following measures:

- Reorient or relocate the receiving antenna.
- Increase the separation between the equipment and receiver.
- Connect the equipment into an outlet on a circuit different from that to which the receiver is connected.
- Consult the dealer or an experienced radio/TV technician for help.

**FCC Caution:** To assure continued compliance, (example – use only shielded interface cables when connecting to computer or peripheral devices). Any changes or modifications not expressly approved by the party responsible for compliance could void the user's authority to operate this equipment. This transmitter must not be co-located or operated in conjunction with any other antenna or transmitter.

### **FCC Radiation Exposure Statement**

*This equipment complies with FCC radiation exposure limits set forth for an uncontrolled environment. This equipment should be installed and operated with a minimum distance of 20 cm between the radiator & your body.*

This device complies with Part 15 of the FCC Rules. Operation is subject to the following two conditions: (1) This device may not cause harmful interference, and (2) this device must accept any interference received, including interference that may cause undesired operation.

FCC 15.407(e): Within the 5.15-5.25 GHz band, U-NII devices will be restricted to indoor operations to reduce any potential for harmful interference to co-channel MSS operations.



## R&TTE Compliance Statement

Moxa declares that the apparatus OnCell 3120-LTE-1 complies with the essential requirements and other relevant provisions of Directive 1999/5/EC.

This equipment complies with all the requirements of DIRECTIVE 1999/5/CE OF THE EUROPEAN PARLIAMENT AND THE COUNCIL OF 9 March 1999 on radio equipment and telecommunication terminal equipment and the mutual recognition of their conformity (R&TTE).

The R&TTE Directive repeals and replaces in the directive 98/13/EEC (Telecommunications Terminal Equipment and Satellite Earth Station Equipment) as of April 8, 2000.

### **Safety**

This equipment is designed with the utmost care for the safety of those who install and use it. However, special attention must be paid to the dangers of electric shock and static electricity when working with electrical equipment. All guidelines of this and of the computer manufacturer must therefore be allowed at all times to ensure the safe use of the equipment.

### **EU Countries Intended for Use**

The ETSI version of this device is intended for home and office use in Austria, Belgium, Denmark, Finland, France (with Frequency channel restrictions), Germany, Greece, Ireland, Italy, Luxembourg, Portugal, Spain, Sweden, The Netherlands, and United Kingdom.

The ETSI version of this device is also authorized for use in EFTA member states Norway and Switzerland.

### **EU Countries Not Intended for Use**

None.

### **Potential Restrictive Use**

France: only channels 10, 11, 12, and 13.

## Dynamic Domain Name Server

This appendix explains how to use the OnCell 3120-LTE-1 with DDNS. When the OnCell 3120-LTE-1 receives its IP address from a DHCP (Dynamic Host Configuration Protocol) server, remote servers will be unable to access it using a fixed IP address. With DDNS (Dynamic Domain Name Server), a remote server can access the OnCell 3120-LTE-1 using its domain name instead of its IP address.

The following is a summary of the process:

1. The OnCell 3120-LTE-1 sends a request for an IP address to the DHCP server. At the same time, it notifies the DHCP server of its desired server name ("OC3100" in the illustration) according to the option 12 standard.
2. The DHCP server replies with the IP address that is assigned to the OnCell 3120-LTE-1, along with the domain name ("moxa.com" in the illustration) and the IP addresses for the DNS server and gateway.
3. If the OnCell 3120-LTE-1 has authorization to update the DNS server, it will register its FQDN (Fully Qualified Domain Name) with the DNS server. The OnCell 3120-LTE-1's FQDN will be in the format *server name.domain name* ("OC3100.moxa.com" in the illustration).
4. If the OnCell 3120-LTE-1 is not authorized to update the DNS server, the DHCP server can be used to update the DNS server. The DHCP server will register the DNS server with the PTR RR (the record of request for a domain name with IP address).

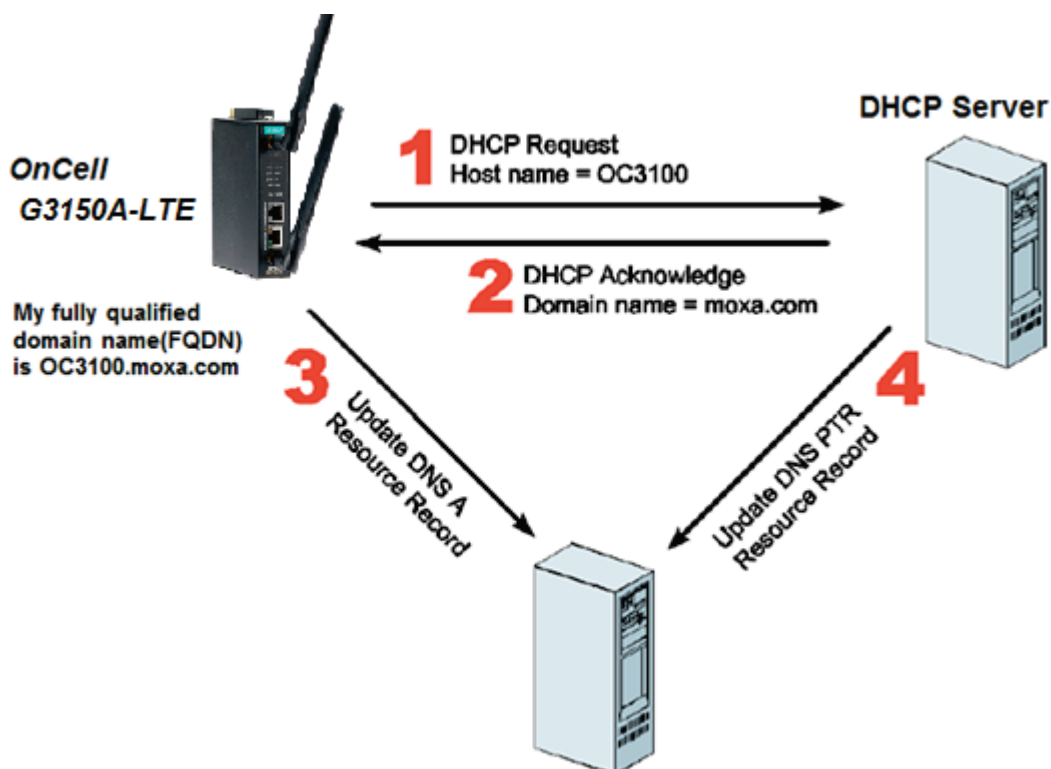

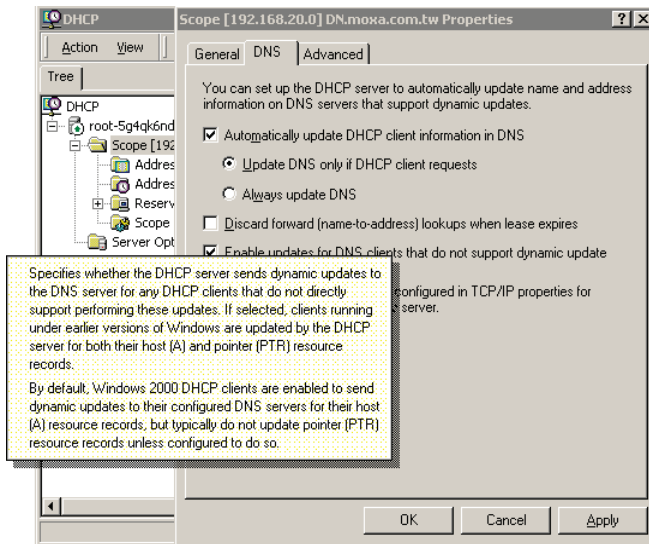

The above screenshot shows how DHCP can be set up to update the DNS.

## Well-known Port Numbers

---

In this appendix, we provide a list of port numbers that may cause network problems if you set the OnCell 3120-LTE-1 to one of these ports. Refer to RFC 1700 standards for a list of well-known port numbers or to the following introduction from the IANA:

The port numbers are divided into three ranges: the Well Known Ports, the Registered Ports, and the Dynamic and/or Private Ports.

The Well Known Ports range from 0 through 1023.

The Registered Ports range from 1024 through 49151.

The Dynamic and/or Private Ports range from 49152 through 65535.

The Well Known Ports are assigned by the IANA, and on most systems, can only be used by system processes or by programs executed by privileged users. The following table shows famous port numbers among the listed well-known port numbers. For more details, please visit the IANA website at <http://www.iana.org/assignments/port-numbers>.

TCP Socket	Application Service
0	Reserved
1	TCP Port Service Multiplexer
2	Management Utility
7	Echo
9	Discard
11	Active Users (sysstat)
13	Daytime
15	Netstat
20	FTP data port
21	FTP control port
23	Telnet
25	SMTP (Simple Mail Transfer Protocol)
37	Time (Time Server)
42	Host name server (names server)
43	Whois (nickname)
49	Login Host Protocol (login)
53	Domain Name Server (domain)
79	Finger protocol (finger)
80	World Wide Web (HTTP)
119	Network News Transfer Protocol (NNTP)
123	Network Time Protocol
213	IPX
160 to 223	Reserved for future use

UDP Socket	Application Service
0	Reserved
2	Management Utility
7	Echo
9	Discard
11	Active Users (sysstat)
13	Daytime
35	Any private printer server
39	Resource Location Protocol
42	Host name server (names server)
43	Whois (nickname)
49	Login Host Protocol (login)
53	Domain Name Server (domain)
69	Trivial Transfer Protocol (TFTP)
70	Gopher Protocol
79	Finger Protocol
80	World Wide Web (HTTP)
107	Remote Telnet Service
111	Sun Remote Procedure Call (Sunrpc)
119	Network News Transfer Protocol (NNTP)
123	Network Time Protocol (NTP)
161	SNMP (Simple Network Mail Protocol)
162	SNMP Traps
213	IPX (used for IP Tunneling)

## AT Commands for Modem Mode

---

This section covers detailed instructions on how to set up Modem mode for the OnCell 3120-LTE-1. In addition, this section also provides a list of all supported AT commands.

The following topics are covered in this appendix:

- ❑ **Setting Up Modem Mode**
- ❑ **List of Supported AT Commands**
  - Alphabetical List of Commands
  - Short Message Service (SMS) Commands
  - Call-related Commands
  - Network Service Commands
  - Configuration Commands
  - Identification Commands Miscellaneous Commands
  - Miscellaneous Commands
  - Packet Domain Related Commands
  - Security Commands
  - Serial Interface Control Commands
  - Status Control Commands



- c. Click **Search** to search for OnCell devices. Select the OnCell 3120-LTE-1 device you want to configure and click **OK**

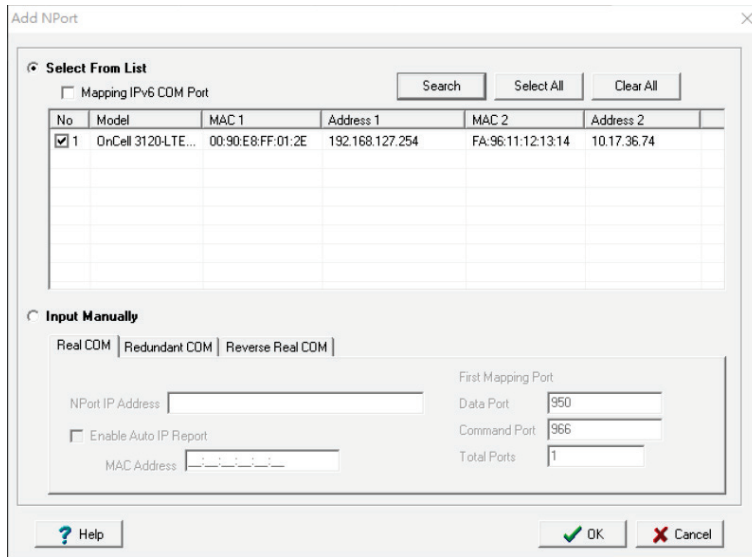

- d. The COM port and the mappings will appear in blue until activated. Click **Yes** to activate the COM port. The port information will be saved in the host system’s registry and the COM port will available for use.

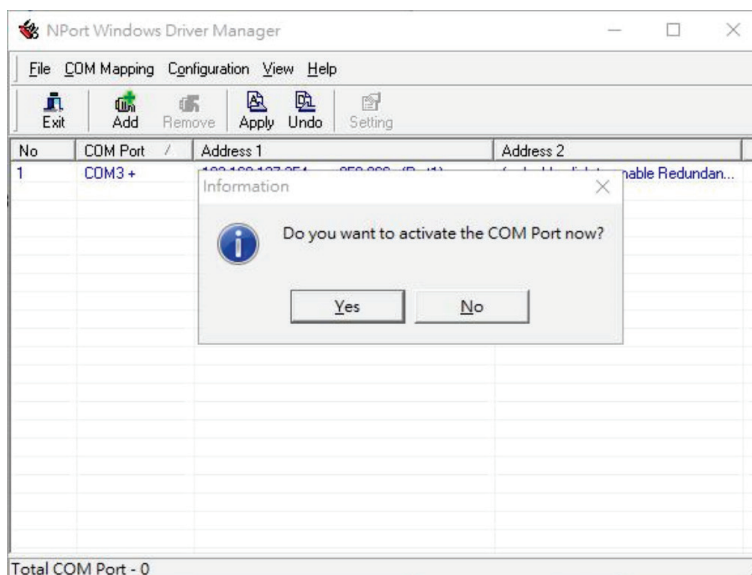

- 3. Set up serial emulator software for data transmission. Moxa recommends PComm. PComm Terminal Emulator is a serial communication tool for Windows, which is available free of charge as part of the PComm Lite suite. You may use a different terminal emulator utility, although appearance and procedures may vary from the following instructions.
  - a. Download PComm Lite from Moxa’s website and install the software.
  - b. Run the PComm Terminal Emulator, go to **Port Manager** and click **Open**.

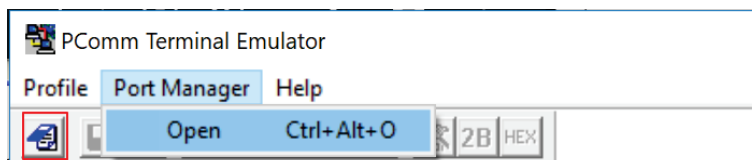

- c. Depending on the selected Modem mode, select the virtual COM port created earlier in Windows Driver Manager (for virtual modem) or the physical COM port of the device (for serial modem) and configure the parameters as follows and click **OK**.

Baud rate: **115200**  
 Data bits: **8**  
 Parity: **None**



Stop bits: **1**

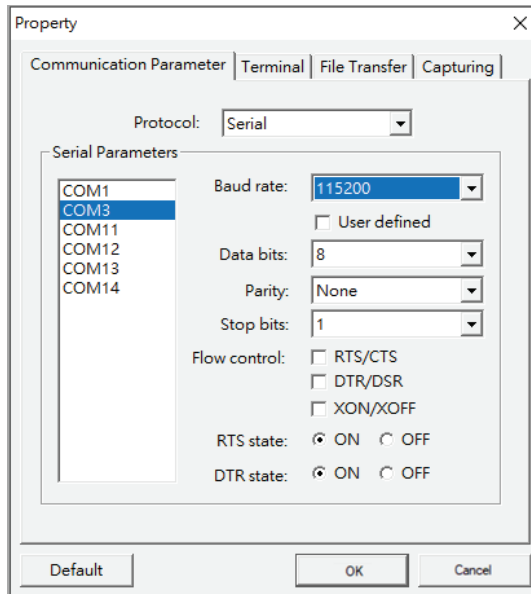

d. You can now use AT commands to transmit data.

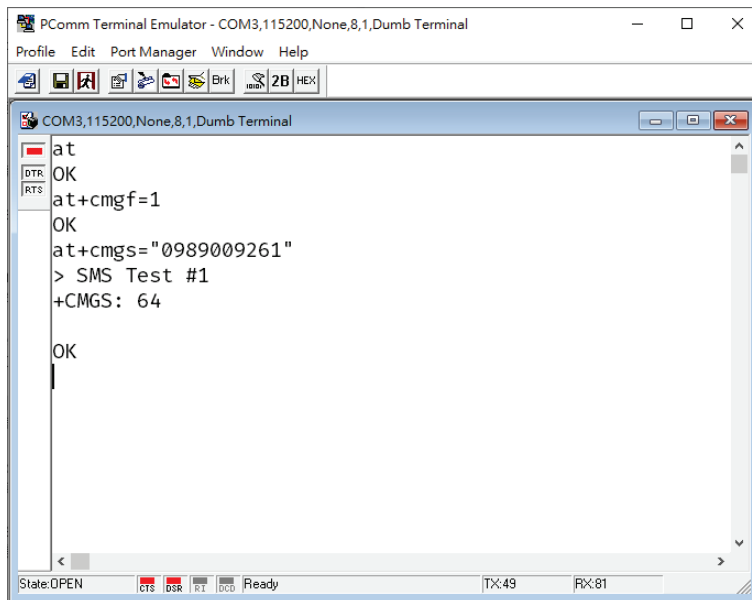

## List of Supported AT Commands

### Alphabetical List of Commands

#	AT Command	Description	Command Type
1	<a href="#">+++</a>	Switch from data mode or PPP online mode to command mode	Call related Commands
2	<a href="#">A/</a>	Repeat Previous Command Line	Miscellaneous Commands
3	<a href="#">AT&amp;F</a>	Reset AT Command Settings to Factory Default Values	Configuration Commands
4	<a href="#">AT&amp;S</a>	Set Data Set Ready (DSR) Line Mode	Serial Interface Control Commands
5	<a href="#">AT&amp;V</a>	Display current configuration	Configuration Commands
6	<a href="#">AT&amp;W</a>	Store AT Command Settings to User Defined Profile	Configuration Commands

7	<a href="#">AT+CEER</a>	Extended Error Report	Status Control Commands
8	<a href="#">AT+CFUN</a>	Functionality Level	Configuration Commands
9	<a href="#">AT+CGMI</a>	Request manufacturer identification	Identification Commands
10	<a href="#">AT+CGMR</a>	Request revision identification of software status	Identification Commands
11	<a href="#">AT+CGSN</a>	Request International Mobile Equipment Identity (IMEI)	Identification Commands
12	<a href="#">AT+CMEE</a>	Error Message Format	Identification Commands
13	<a href="#">AT+CMGD</a>	Delete short message	Short Message Service (SMS) Commands
14	<a href="#">AT+CMGF</a>	Select SMS message format	Short Message Service (SMS) Commands
15	<a href="#">AT+CMGL</a>	List SMS messages from preferred store	Short Message Service (SMS) Commands
16	<a href="#">AT+CMGR</a>	Read SMS messages	Short Message Service (SMS) Commands
17	<a href="#">AT+CMGS</a>	Send SMS	Short Message Service (SMS) Commands
18	<a href="#">AT+CNMI</a>	SMS Event Reporting Configuration	Short Message Service (SMS) Commands
19	<a href="#">AT+COPS</a>	Operator Selection	Network Service Commands
20	<a href="#">AT+CPIN</a>	PIN Authentication	Security Commands
21	<a href="#">AT+CPWD</a>	Change Password	Security Commands
22	<a href="#">AT+CRC</a>	Incoming Call Indication Format	Call related Commands
23	<a href="#">AT+CREG</a>	Network Registration Status	Network Service Commands
24	<a href="#">AT+CSCA</a>	SMS Service Center Address	Short Message Service (SMS) Commands
25	<a href="#">AT+CSCS</a>	Character Set	Configuration Commands
26	<a href="#">AT+CSMP</a>	Set SMS Text Mode Parameters	Short Message Service (SMS) Commands
27	<a href="#">AT+CSQ</a>	Signal quality	Network Service Commands
28	<a href="#">AT+CSTA</a>	Select type of address	Call related Commands
29	<a href="#">AT+ICF</a>	Character Framing	Serial Interface Control Commands
30	<a href="#">AT+IPR</a>	Bit Rate	Serial Interface Control Commands
31	<a href="#">ATA</a>	Connect to Incoming Call	Call related Commands
32	<a href="#">ATD</a>	Mobile originated call to specified number	Call related Commands
33	<a href="#">ATDL</a>	Redial last number used	Call related Commands
34	<a href="#">ATE</a>	AT Command Echo	Serial Interface Control Commands
35	<a href="#">ATH</a>	Disconnect existing connection	Packet Domain Related Commands
36	<a href="#">ATI</a>	Display product identification information	Identification Commands
37	<a href="#">ATQ</a>	Result Code Presentation Mode	Configuration Commands
38	<a href="#">ATSQ</a>	Set number of rings before automatically answering a call	Call related Commands
39	<a href="#">ATV</a>	Result code format mode	Configuration Commands
40	<a href="#">ATZ</a>	Restore AT Command Settings from User Defined Profile	Configuration Commands

## Short Message Service (SMS) Commands

### Common SMS Parameters

<index>		
Integer type; value in the range of location numbers supported by the associated memory.		
<stat>		
PDU mode (<mode>=0)	text mode (<mode>=1)	Description
0	"REC UNREAD"	Received unread messages
1	"REC READ"	Received read messages
2	"STO UNSENT"	Stored unsent messages. SMS writing commands default state
3	"STO SENT"	Stored sent messages
4	"ALL"	All messages
<oa>		
Originating Address		
<da>		
Destination Address		
<ra>		
Recipient Address		
<sca>		
Service Center Address		
<tooa>		
Type of Originating Address. 3GPP TS 24.011 [39] TP-Destination-Address Type-of-Address octet in integer format (when first character of <da> is + (IRA 43) default is 145, otherwise default is 129) 0...255		
<toda>		
Type of Destination Address		
<tora>		
Type of Recipient Address		
<tosca>		
Type of Service Center Address		
<length>		
Message Length Integer type value indicating in the text mode (AT+CMGF=1) the length of the message body <data> in characters; or in PDU mode (AT+CMGF=0), the length of the actual TP data unit in octets.		
<fo>		
First Octet		
<mr>		
Message Reference		
<scts>		
Service Centre Time Stamp		
<dt>		
Discharge Time		
<st>		
Status		
<ct>		
Command Type		
<pid>		

Protocol Identifier
<dc>
Data Coding Scheme
<vp>
Validity Period
<mn>
Message Number

**AT+CMGD Delete short message**

Exec Command
AT+CMGD=<index>[, <delflag>]
Response(s)
OK ERROR +CMS ERROR: <err>
<delflag>
0: (Or omitted) delete the message specified in <index>.
1: Delete all read messages from preferred message storage, leaving unread messages and stored mobile originated messages (whether sent or not) untouched.
2: Delete all read messages from preferred message storage and sent mobile originated messages, leaving unread messages and unsent mobile originated messages untouched.
3: Delete all read messages from preferred message storage, sent and unsent mobile originated messages leaving unread messages untouched.
4: Delete all messages from preferred message storage including unread messages.

**AT+CMGF Select SMS message format**

Read Command	Write Command
AT+CMGF?	AT+CMGF=[<mode>]
Response(s)	Response(s)
+CMGF: <mode> OK ERROR +CMS ERROR: <err>	OK ERROR +CMS ERROR: <err>
<mode>	
0: PDU mode. Default value set if parameter is omitted. Default Factory value.	
1: Text mode	

**AT+CMGL List SMS messages from preferred store**

Exec Command	Write Command
AT+CMGL	AT+CMGL=<stat>
Response(s)	Response(s)
+CMGL: <stat> OK	<p><b>Output if text mode (AT+CMGF=1) and command successful:</b></p> <p>For SMS- SUBMITs and/or SMS-DELIVERs                      +CMGL: &lt;index&gt;, &lt;stat&gt;, &lt;oa&gt;/&lt;da&gt;,,                      [&lt;scts&gt;][, &lt;tooa&gt;/&lt;toda&gt;,                      &lt;length&gt;]&lt;CR&gt;&lt;LF&gt;&lt;data&gt;&lt;CR&gt;&lt;LF&gt;                      [... ]                      OK</p> <p>For SMS-STATUS-REPORTs</p>

	<p>+CMGL: &lt;index&gt;, &lt;stat&gt;, &lt;fo&gt;, &lt;mr&gt;, [ &lt;ra&gt;], [ &lt;tora&gt;], &lt;scts&gt;, &lt;dt&gt;, &lt;st&gt;&lt;CR&gt;&lt;LF&gt; [... ] OK</p> <p>For SMS-Commands +CMGL: &lt;index&gt;, &lt;stat&gt;, &lt;fo&gt;, &lt;ct&gt;&lt;CR&gt;&lt;LF&gt; [... ] OK</p> <p><b>Output if PDU mode AT+CMGF=0 and command successful:</b> For SMS-SUBMITs and/or SMS-DELIVERs +CMGL: &lt;index&gt;, &lt;stat&gt;,, &lt;length&gt;&lt;CR&gt;&lt;LF&gt;&lt;pdu&gt;&lt;CR&gt;&lt;LF&gt; [... ] OK</p> <p>If error is related to functionality ERROR +CMS ERROR: &lt;err&gt;</p>
--	--

**AT+CMGR Read SMS messages**

Write Command
AT+CMGR=<index>
Response(s)
<p><b>Output if text mode (AT+CMGF=1) and command successful:</b> For SMS-DELIVER +CMGR: &lt;stat&gt;, &lt;oa&gt;,,&lt;scts&gt;[, &lt;tooa&gt;, &lt;fo&gt;, &lt;pid&gt;, &lt;dcs&gt;, &lt;sca&gt;, &lt;tosca&gt;, &lt;length&gt;]&lt;CR&gt;&lt;LF&gt;&lt;data&gt; [... ] OK</p> <p>For SMS-SUBMIT +CMGR: &lt;stat&gt;, &lt;da&gt;, [, &lt;toda&gt;, &lt;fo&gt;, &lt;pid&gt;, &lt;dcs&gt;, [&lt;vp&gt;], &lt;sca&gt;, &lt;tosca&gt;, &lt;length&gt;]&lt;CR&gt;&lt;LF&gt;&lt;data&gt; [... ] OK</p> <p>For SMS-STATUS-REPORT +CMGR: &lt;stat&gt;, &lt;fo&gt;, &lt;mr&gt;, [&lt;ra&gt;], [&lt;tora&gt;], &lt;scts&gt;, &lt;dt&gt;, &lt;st&gt; &lt;data&gt; [... ] OK</p> <p>For SMS-Commands +CMGR: &lt;stat&gt;, &lt;fo&gt;, &lt;ct&gt;[, &lt;pid&gt;, [&lt;mn&gt;], [&lt;da&gt;], [&lt;toda&gt;], &lt;length&gt;]&lt;CR&gt;&lt;LF&gt;&lt;data&gt; [... ] OK</p> <p><b>Output if PDU mode (AT+CMGF=0) and command successful:</b> For SMS-SUBMITs and/or SMS-DELIVERs</p>

+CMGR: <stat>,, <length><CR><LF><pdu> [... ] OK ERROR +CMS ERROR: <err>
---

**AT+CMGS Send SMS**

Write Command If text mode	Write Command If PDU mode
AT+CMGS=<da>[, <tda>]<CR> Text can be entered. <CTRL-Z>/<ESC>	AT+CMGS=<length><CR> PDU can be entered. <CTRL-Z>/<ESC>
Response(s)	Response(s)
+CMGS: <mr>[, <scts>] OK	+CMGS: <mr>[, <ackpdu>] OK

**AT+CNMI SMS Event Reporting Configuration**

Read Command	Write Command
AT+CNMI?	AT+CNMI=<mode>[, <mt>[, <bm>[, <ds>[, <bfr>]]]]
Response(s)	Response(s)
+CNMI: <mode>, <mt>, <bm>, <ds>, <bfr> OK	OK ERROR +CMS ERROR: <err>
<mode>	
0: SMS related URCs are always buffered. If the buffer is full, the oldest indications are discarded and replaced with newly received indications. Default value set if parameter is omitted.	
1: SMS related URCs are forwarded directly to the terminal equipment. However, if this is not possible because the link between terminal equipment is reserved, e.g. during a data call, these URCs are discarded.	
2: SMS related URCs are forwarded directly to the terminal equipment. However, if this is not possible because the link between terminal equipment is reserved these URCs are buffered and flushed to the terminal equipment afterwards.	
<mt>	
0: No SMS-DELIVER indications are routed to the terminal equipment. Default value set if parameter is omitted. Default factory value.	
1: Class 0 SMS-DELIVERs are routed directly to the terminal equipment via URC. For all other messages the following applies: If SMS-DELIVER is stored in user equipment, indication of the memory location is routed to the terminal equipment via URC.	
2: SMS-DELIVERs, except class 2 messages and messages in the message waiting indication group (store message) are routed directly to the terminal equipment via URC.	
3: Class 0 and 3 SMS-DELIVERs are routed directly to the terminal equipment via URCs defined for <mt>=2. Messages of other data coding schemes result in indication as defined for <mt>=1.	
<bm>	
0: No Cell Broadcast Message indications are routed to the terminal equipment. Default value set if parameter is omitted. Default factory value.	
1: If Cell Broadcast Message is stored into cellular module, indication of the memory location is routed to the terminal equipment.	
2: New Cell Broadcast Messages are routed directly to the terminal equipment via URC.	
3: Class 3 Cell Broadcast Messages are routed directly to the terminal equipment via URC.	
<ds>	
0: No SMS-STATUS-REPORTs are routed to the terminal equipment. Default value set if parameter is omitted. Default factory value.	
1: SMS-STATUS-REPORTs are routed to the terminal equipment via URC.	

2: If SMS-STATUS-REPORT is routed into terminal equipment, indication of the memory location is routed to the terminal equipment via URC.
<bfr>
0: Buffer of SMS related URCs is flushed to the terminal equipment when <mode> changes from 0 to 1, 2 or 3.
1: Buffer of SMS related URCs is cleared when <mode> changes from 0 to 1, 2 or 3.

**AT+CSCA SMS Service Center Address**

Read Command	Write Command
AT+CSCA?	AT+CSCA=<sca>[, <tosca>]
Response(s)	Response(s)
+CSCA: <sca>, <tosca> OK	OK

**AT+CSMP Set SMS Text Mode Parameters**

Read Command	Write Command
AT+CSMP?	AT+CSMP=<fo>, <vp>/<scts>[, <pid>[, <dc>]]
Response(s)	Response(s)
+CSMP:<fo>, <vp>/ <scts>, <pid>, <dc> OK	OK ERROR +CMS ERROR: <err>

## Call-related Commands

**+++Switch from data mode or PPP online mode to command mode**

Exec Command
+++
Response(s)
OK

**AT+CRC Incoming Call Indication Format**

Read Command	Write Command
AT+CRC?	AT+CRC=[<mode>]
Response(s)	Response(s)
+CRC: <mode> OK ERROR	OK ERROR
<mode>	
0: Disable extended format. Default value set if parameter is omitted.	
1: Enable extended format.	

**AT+CSTA Select type of address**

Read Command	Write Command
AT+CSTA?	AT+CSTA=<type>
Response(s)	Response(s)
+CSTA: <type> OK	OK ERROR

<type>
145: When dialing string includes international access code character "+"
129: Otherwise

**ATA Connect to Incoming Call**

Exec Command
ATA
Response(s)
In case of voice call, if successfully connected: OK If incoming call is not available, i.e. already disconnected or hanged up: NO CARRIER

**ATD Mobile originated call to specified number**

Exec Command
ATD<n>[<mgsms>][;]
Response(s)
If voice call and command input is completed: OK If no dialtone: NO DIALTONE If busy: BUSY If connection cannot be set up: NO CARRIER NO ANSWER ERROR +CME ERROR: <err>
<n>
<n> is default for last number that can be dialed by <a href="#">ATDL</a> .

**ATDL Redial last number used**

Exec Command
ATDL[;]
Response(s)
If voice call and command input is completed: OK If no dialtone: NO DIALTONE If busy: BUSY If connection cannot be set up: NO CARRIER NO ANSWER ERROR +CME ERROR: <err>

**ATS0 Set number of rings before automatically answering a call**

Read Command	Write Command
ATS0?	ATS0=<n>
Response(s)	Response(s)



<n> OK ERROR	OK ERROR
<n>	
000: Automatic answer mode is disabled. Factory default value.	
001-255: Enable automatic answering after specified number of rings.	

## Network Service Commands

### AT+COPS Operator Selection

Read Command	Write Command
AT+COPS?	AT+COPS=[<mode>[, <format>[, <opName>]][, <Act>]]
Response(s)	Response(s)
+COPS:<mode>[, <format>[, <opName>][, <Act>]] OK ERROR +CME ERROR:<err>	OK ERROR +CME ERROR:<err>
<mode>	
0: Automatic mode; <opName> field is ignored. Default after SIM PIN authentication has completed	
1: Manual operator selection.	
2: Manually deregister from network and remain unregistered until <mode>=0 or 1 or 4 is selected.	
3: Set only <format> (for AT+COPS read command).	
4: Automatic / manual selection; if manual selection fails, automatic mode (<mode>=0) is entered (<opName> field will be present).	
<format>	
0: Long alphanumeric format of <opName>. Factory default value.	
1: Short alphanumeric format of <opName>.	
2: Numeric format of <opName>. This is the Location Area Identification (LAI) number, which consists of the 3-digit Mobile Country Code (MCC) plus the 2- or 3-digit Mobile Network Code (MNC).	
<Act>	
0: GSM	
2: UTRAN	
7: E-UTRAN	

### AT+CREG Network Registration Status

Read Command	Write Command
AT+CREG?	AT+CREG=[<Mode>]
Response(s)	Response(s)
+CREG: <Mode>, <regStatus>[, <netLac>, <netCellId>[, <Act>]] OK ERROR +CME ERROR: <err>	OK ERROR +CME ERROR: <err>
<Mode>	
0: Disables +CREG URC(Unsolicited Result Code). Factory default value. Default value set if parameter is omitted.	

1: Enables indication of network registration status +CREG: <regStatus> both by AT+CREG? read command and by +CREG URC(Unsolicited Result Code).
2: Enables extended status information +CREG:<regStatus>[,<net-Lac>,<netCellId> [, <AcT>]], both by read command AT+CREG? and by +CREG URC.
<regStatus>
0: Not registered, cellular module is currently not searching for new operator
1: Registered to home network
2: Not registered, but cellular module is currently searching for a new operator.
3: Registration denied
4: Unknown, e.g. out of GSM/UMTS/LTE coverage.
5: Registered, roaming. Cellular module is registered at a foreign network (national or international network)
<netLac>
Two-byte location area code in hexadecimal format (e.g. "00C3" equals 195 in decimal).
<netCellId>
Cell ID in hexadecimal format. 2G: 16 bit; 3G/4G: 28 bit.
<AcT>
0: GSM
2: UTRAN
3: GSM w/EGPRS
4: UTRAN w/HSDPA
5: UTRAN w/HSUPA
6: UTRAN w/HSDPA and w/HSUPA
7: E-UTRAN

**AT+CSQ Signal quality**

Exec Command
AT+CSQ
Response(s)
+CSQ: <rssi>,<ber>
OK
<rssi>
0: -113 dBm or less
1: -111 dBm
2...30: -109... -53 dBm
31: -51 dBm or greater
99: not known or not detectable
<ber>
0...7: as RXQUAL values in the table in 3GPP TS 45.008 [50] section 8.2.4.
99: not known or not detectable

**Configuration Commands****AT&F Reset AT Command Settings to Factory Default Values**

Exec Command
AT&F[0]
Response(s)
OK

**AT&V Display current configuration**

Exec Command
AT&V[0]
Response(s)
ACTIVE PROFILE: ... OK

**AT&W Store AT Command Settings to User Defined Profile**

Exec Command
AT&W[0]
Response(s)
OK ERROR +CME ERROR: <err>

**AT+CFUN Functionality Level**

Read Command	Write Command
AT+CFUN?	AT+CFUN=<fun>[, <rst>]
Response(s)	Response(s)
+CFUN: <power_mode> OK ERROR +CME ERROR: <err>	OK ERROR +CME ERROR: <err> If <fun>= 0: OK ^SHUTDOWN If <rst>= 1: OK ^SYSSTART
<power_mode>	
1: Cellular module is switched on	
4: Airplane mode	
<fun>	
0: Switch off cellular module.	
1: (Default) Full functionality level.	
4: Airplane mode.	
<rst>	
0: Cellular module switches to <fun> level without reset. Default value set if parameter is omitted.	
1: Cellular module resets and restarts to <fun> level	

**AT+CSCS Character Set**

Read Command	Write Command
AT+CSCS?	AT+CSCS=<chset>
Response(s)	Response(s)
+CSCS: <chset> OK	OK ERROR +CME ERROR: <err>
<chset>	
"GSM": GSM 7 bit default alphabet	

"UCS2": 16-bit universal multiple-octet coded character set. UCS2 character strings are converted to hexadecimal numbers in the range 0000 to FFFF; e.g. "004100620063" equates to three 16-bit characters with decimal values 65, 98 and 99.

#### **ATQ Result Code Presentation Mode**

Exec Command
ATQ[<n>]
Response(s)
If <n>=0: OK If <n>=1: (none)
<n>
0: Cellular module transmits result code. Default value set if parameter is omitted. It is not recommended to change this value.
1: Result codes are suppressed and not transmitted.

#### **ATV Result code format mode**

Exec Command
ATV[<value>]
Response(s)
OK ERROR
<value>
0: Information response: <text><CR><LF>; Short result code format: <numeric code><CR>. Default value set if parameter is omitted.
1: Information response: <CR><LF><text><CR><LF>; Long result code format: <CR><LF><verbose code><CR><LF>. Factory default value.

#### **ATZ Restore AT Command Settings from User Defined Profile**

Exec Command
ATZ[0]
Response(s)
OK

## **Identification Commands Miscellaneous Commands**

#### **AT+CGMI Request manufacturer identification**

Exec Command
AT+CGMI
Response(s)
Cinterion OK

#### **AT+CGMR Request revision identification of software status**

Exec Command
AT+CGMR
Response(s)
<sn> OK

**AT+CGSN Request International Mobile Equipment Identity (IMEI)**

Exec Command
AT+CGSN
Response(s)
<IMEI> OK

**AT+CMEE Error Message Format**

Read Command	Write Command
AT+CMEE?	AT+CMEE=<errMode>
Response(s)	Response(s)
+CMEE: <errMode> OK	OK ERROR +CME ERROR: <err>
<errMode>	
0: Disable result code, i.e. only "ERROR" will be displayed. Factory default value.	
1: Enable error result code with numeric values.	
2: Enable error result code with verbose (string) values	

**ATI Display product identification information**

Exec Command
ATI
Response(s)
Cinterion ELS61-E-R2 REVISION xx.yyy OK

## Miscellaneous Commands

**A/ Repeat Previous Command Line**

Exec Command
A/
Response(s)
(Response of Previous Command Line)

## Packet Domain Related Commands

**ATH Disconnect existing connection**

Exec Command
ATH
Response(s)
OK

## Security Commands

### AT+CPIN PIN Authentication

Read Command	Write Command
AT+CPIN?	AT+CPIN=<pin>[, <new pin>]
Response(s)	Response(s)
+CPIN: <code> OK ERROR +CME ERROR: <err>	OK ERROR +CME ERROR: <err>
<code>	
READY: PIN has already been entered. No further entry needed.	
SIM PIN: Waiting for SIM PIN1.	
SIM PUK: Waiting for SIM PUK1 if PIN1 was disabled after three failed attempts to enter PIN1.	
SIM PIN2: Waiting for PIN2.	
SIM PUK2: Waiting for PUK2 to unblock a disabled PIN2.	

### AT+CPWD Change Password

Write Command
AT+CPWD=<facility>, <old password>[, <new password>]
Response(s)
Response(s)
New password has been registered for the facility lock function: OK If parameter <old password> was not correct: +CME ERROR: 16 (+CME ERROR: incorrect password) If the password for the selected <facility> has been invalidated due to too many failed attempts: +CME ERROR: ... If error is related to functionality: +CME ERROR: <err>
<facility>
"SC": SIM PIN. USIM requests password upon cellular module power-up and when this lock command is issued. If incorrectly entered three times, the SIM PUK is required to perform authentication.
"PS": Phone locked to USIM card. Cellular module requests password when other than current USIM card is inserted. "PS" lock is frequently referred to as "phone lock", or "device lock".
"P2": SIM PIN 2, e.g. required for authentication with facility lock. If incorrectly entered three times, the SIM PUK 2 is required to perform authentication.

## Serial Interface Control Commands

### AT&S Set Data Set Ready (DSR) Line Mode

Exec Command
AT&S[<value>]
Response(s)
OK
<value>
0: DSR line is always ON. Default value set if parameter is omitted. Default factory value.
1: In command mode: DSR is OFF; In data mode: DSR is ON.

**AT+ICF Character Framing**

Read Command	Write Command
AT+ICF?	AT+ICF=[<format>[, <parity>]]
Response(s)	Response(s)
+ICF: <format>[, <parity>] OK	OK ERROR +CME ERROR: <err>
<format>	
1: 8 data 0 parity 2 stop	
2: 8 data 1 parity 1 stop	
3: 8 data 0 parity 1 stop. Default factory value.	
5: 7 data 1 parity 1 stop	
<parity> If <format> does not support parity, this parameter has to be omitted.	
0: odd	
1: even	

**AT+IPR Bit Rate**

Read Command	Write Command
AT+IPR?	AT+IPR=<rate>
Response(s)	Response(s)
+IPR: <rate> OK	OK ERROR +CME ERROR: <err>
<rate>	
0: Autobauding	
1200/2400/4800/9600/115200	

**ATE AT Command Echo**

Exec Command
ATE[<value>]
Response(s)
OK
<value>
0: Echo mode off. Default value set if parameter is omitted.
1: Echo mode on. Default factory value

## Status Control Commands

**AT+CEER Extended Error Report**

Exec Command	Write Command
AT+CEER	AT+CEER=<reset>
Response(s)	Response(s)
In case of CC and SM categories: +CEER: <category>[, <cause>, <description>]  In case of SS category network error cause and network GSM cause: +CEER: <category>, <cause>	OK ERROR +CME ERROR

In case of SS category network reject cause: +CEER: <category>, <tag>, <cause> OK ERROR +CME ERROR: <err>	
<category>	
"No report available"	
"CC setup error": Call Control setup error	
"CC modification error": Call Control modification error	
"CC release": Call Control release	
"SM attach error" : Session Management attach error	
"SM detach": Session Management detach	
"SM activation error": Session Management activation error	
"SM deactivation": Session Management deactivation	
"SS network error cause": Supplementary Services network error cause	
"SS network reject cause": Supplementary Services network reject cause	
"SS network GSM cause": Supplementary Services network GSM cause	
<cause>	
Cause for last call release or error as number code. Sent by network or internally.	
<description>	
Verbose string containing the textual representation of the cause.	
<tag>	
Numeric value indicating an Supplementary Services Reject code.	
<reset>	
0: Reset the extended error report to initial value.	