

UC-8200 Series Quick Installation Guide

Version 2.3, February 2022

Technical Support Contact Information
www.moxa.com/support

MOXA®

© 2022 Moxa Inc. All rights reserved.

P/N: 1802082000014



Overview

The UC-8200 Series computing platform is designed for embedded data acquisition applications. The UC-8200 Series computer comes with two RS-232/422/485 serial ports and dual 10/100/1000 Mbps Ethernet LAN ports, as well as two Mini PCIe sockets to support cellular and Wi-Fi modules. These versatile communication capabilities let users efficiently adapt the UC-8200 Series to a variety of complex communications solutions.

Package Checklist

Before installing the UC-8200 Series, verify that the package contains the following items:

- UC-8200 Series embedded computer
- Power jack
- Console cable
- DIN-rail mounting kit
- Quick installation guide (printed)
- Warranty card



IMPORTANT!

Notify your sales representative if any of the above items are missing or damaged.

Panel Layout

The panel layouts of the UC-8200 models are given below:

UC-8210

Panel View

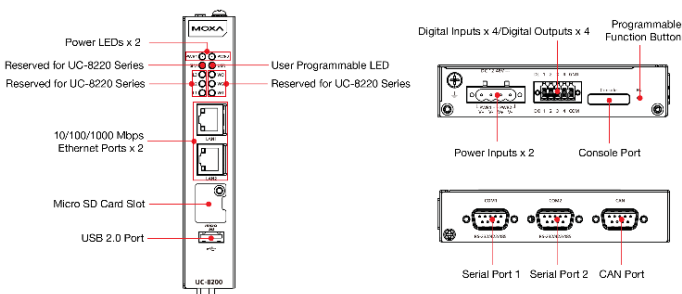

UC-8220

Panel View

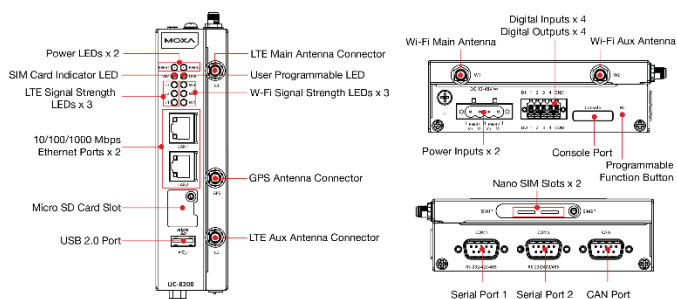

LED Indicator

LED Name	Status	Function	
PWR1/PWR2	Green	Power is on	
	Off	No power	
SIM	Green	SIM2 in use	
	Yellow	SIM1 in use	
USR	Green/Yellow	User programmable	
L1/L2/L3	Yellow	Cellular signal strength	
		L1+L2+L3: Strong	
		L2+L3: Normal L3:Weak	
W1/W2/W3	Yellow	WLAN signal strength	
		L1+L2+L3: strong	
		L2+L3: normal L3: weak	
LAN1/LAN 2 (RJ45 connector)	Green	Steady on	1000 Mbps Ethernet link
		Blinking	Data is being transmitted
	Yellow	Steady on	100 Mbps Ethernet link
		Blinking	Data is being transmitted
	Off	No Ethernet connection	

Installing the UC-8200 Series

DIN-rail Mounting

The aluminum DIN-rail attachment plate is attached to the product's casing. To mount the UC-8200 Series on to a DIN rail, ensure that the stiff metal spring is facing upwards and follow these steps.

1. Pull down the bottom slider of the DIN-rail bracket located at the back of the unit
2. Insert the top of the DIN rail into the slot just below the upper hook of the DIN-rail bracket.
3. Latch the unit firmly on to the DIN rail as shown in the illustrations below.
4. Push the slider back into place.

UC-8210



UC-8220

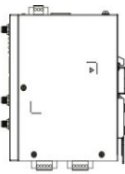
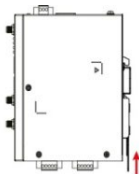
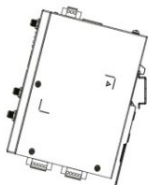
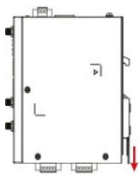
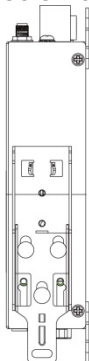

Wall Mounting (optional)

The UC-8200 Series can be mounted on to a wall using a wall-mounting kit. The optional wall-mounting kit should be purchased separately.

Follow these steps to mount the computer on to a wall:

Step 1

Use four screws to fasten the wall-mounting brackets on the left panel of the computer.

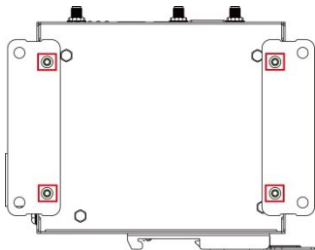

Step 2

Use another four screws to mount the computer on to a wall or in a cabinet.

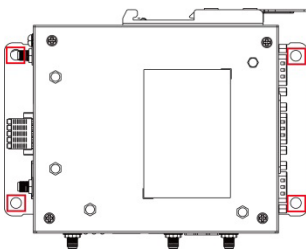



IMPORTANT!

The diameter of the screw heads should be greater than 7 mm and less than 14 mm; the diameter of the shafts should be less than 3 mm. The length of the screws should be greater than 6 mm.

- NOTE**
- Test the screw head and shank size by inserting the screws into one of the keyhole shaped apertures of the wall-mounting plates before attaching the plate to the wall.
 - Do not drive the screws in all the way—leave a space of about 2 mm to allow room for sliding the wall mount panel between the wall and the screws.

Connector Description

Power Connector

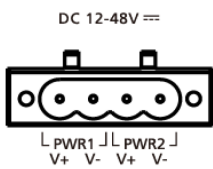

Connect the power jack (in the package) to the UC-8200 Series' DC terminal block (located on the top panel), and then connect the power adapter. It takes about 30 seconds for the system to boot up. Once the system is ready, the Power LED will light up. Both models support dual power inputs for redundancy.

Use wires with 16 to 24 AWG (1.318 to 0.205 mm²) to connect to V+, V-, and GND. The wire size of the power input and the earthing conductor should be the same.



WARNING

- This product is intended to be supplied by a UL Listed power adapter or DC power source whose output meets SELV/LPS. The power source must be rated 12 to 48 VDC, minimum 1 A, and minimum T_{ma} = 85°C.
- The power adapter should be connected to a socket outlet with earthing connection.

If you need further information or assistance, contact a Moxa representative.

Grounding the Computer

There is a grounding connector located on the top panel of the computer. Grounding and wire routing help limit the effects of noise due to electromagnetic interference (EMI). Connect to an appropriate grounded metal surface.

Ethernet Ports

The two 10/100/1000 Mbps Ethernet ports (LAN 1 and LAN 2) use RJ45 connectors.

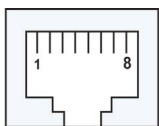

Pin	10/100 Mbps	1000 Mbps
1	Tx+	TRD(0)+
2	Tx-	TRD(0)-
3	Rx+	TRD(1)+
4	-	TRD(2)+
5	-	TRD(2)-
6	Rx-	TRD(1)-
7	-	TRD(3)+
8	-	TRD(3)-

Serial Ports

The two serial ports (P1 and P2) use DB9 interface. Each port can be configured by software for RS-232, RS-422, or RS-485. The pin assignments for the ports are shown in the following table:

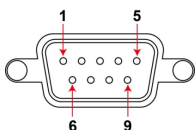

Pin	RS-232	RS-422/ RS-485 4w	RS-485 2w
1	-	TxD-(A)	-
2	RxD	TxD+(B)	-
3	TxD	RxD+(B)	Data+(B)
4	DTR	RxD-(A)	Data-(A)
5	GND	GND	GND
6	DSR	-	-
7	RTS	-	-
8	CTS	-	-

microSD Card Sockets

The UC-8200 Series comes with a micro SD socket for storage expansion. The microSD socket is located at the lower part on the front panel. To install the card, remove the screw and the protection cover to access the socket, and then insert the microSD card into the socket directly. You will hear a click when the card is in place. To remove the card, push the card in before releasing it.



Console Port

The console port is an RS-232 port located on the top panel, and can be connected to a 4-pin pin header cable. You can use this port for debugging or firmware upgrade.



Pin	Signal
1	TxD
2	RxD
3	NC
4	GND

USB Port

The USB 2.0 port is located at the lower part of the front panel and supports a USB storage device driver. By default, the USB storage is mounted at `/mnt/usbstorage`.

CAN Port

A CAN port with a DB9 interface is located on the bottom panel. Refer to the figure below for detailed pin definitions.

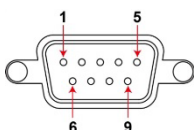

Pin	Definition
1	-
2	CAN_L
3	CAN_GND
4	-
5	(CAN_SHLD)
6	(GND)
7	CAN_H
8	-
9	(CAN_V+)

Digital Inputs/Outputs

DI 1 2 3 4 GND

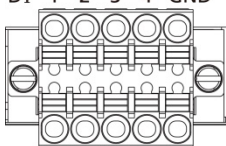

DO 1 2 3 4 COM

There are four digital inputs and four digital outputs on the top panel. Refer to the figure on the left for detailed pin definitions.

SIM Card Socket

The UC-8220 computer comes with a SIM card socket that allows users to install two SIM card for the cellular communication.

Step 1

Remove the screw on the SIM card holder cover located on the bottom panel of the UC-8220 computer.

Step 2

Insert the SIM card into the socket. Make sure you insert in the right direction. To remove the SIM card, press the SIM card in to release and then you can pull out the SIM card.



Real-time Clock

The real-time clock in the UC-8200 Series is powered by a lithium battery. We strongly recommend that you do not replace the lithium battery without the help of a Moxa support engineer. If you need to change the battery, contact the Moxa RMA service team.



ATTENTION

There is a risk of explosion if the battery is replaced with an incorrect type of battery.

Accessing the UC-8200 Series Using a PC

You can use a PC to access the UC-8200 Series by one of the following methods:

- A. Through the serial console port with the following settings:
Baudrate=115200 bps, **Parity**=None, **Data bits**=8, **Stop bits**=1, **Flow Control**=None



ATTENTION

Remember to choose the "VT100" terminal type. Use the console cable to connect a PC to the UC-8200 Series's serial console port.

- B. Using SSH over the network.
Refer to the following IP addresses and login information:

	Default IP Address	Netmask
LAN 1	192.168.3.127	255.255.255.0
LAN 2	192.168.4.127	255.255.255.0

Login: moxa

Password: moxa



ATTENTION

- The equipment shall only be used in an area of not more than pollution degree 2, as defined in IEC/EN 60664-1.
- The equipment shall be installed in an enclosure that provides a degree of protection not less than IP 54 in accordance with IEC/EN 60079-15 and accessible only by the use of a tool.
- These devices are open-type devices that are to be installed in an enclosure with tool removable cover or door, suitable for the environment.
- This equipment is suitable for use in Class I, Division 2, Groups A, B, C, and D or non-hazardous locations only.
- ANTENNAS INTENDED FOR USE IN CLASS I, DIVISION 2 HAZARDOUS LOCATIONS MUST BE INSTALLED WITHIN THE END-USE ENCLOSURE. FOR REMOTE MOUNTING IN AN UNCLASSIFIED LOCATION, ROUTING AND INSTALLATION OF THE ANTENNAS SHALL BE IN ACCORDANCE WITH NATIONAL ELECTRICAL CODE REQUIREMENTS (NEC/CEC) Sec. 501.10 (b).
- The "USB, RS-232/422/485 serial ports, LAN1, LAN2, and Console ports" and Reset Button may only be accessed for equipment set-up, installation, and maintenance at a non-hazardous location. These ports and their associated interconnecting cables must remain inaccessible within the hazardous location.

Installing the Cellular Module

The UC-8220 Series comes with two PCIe sockets, allowing users to install a cellular and a Wi-Fi module. Some models have been shipped with a built-in cellular module inside the computer. However, if you purchase the UC-8200 series without a cellular module, follow these steps to install the cellular module.

1. Remove the four screws on the side panel of the computer.
2. Remove two screws on the other side panel to open the side cover of the computer.

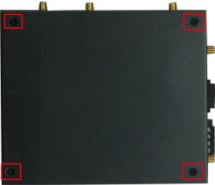

3. The socket is located on the main board of the computer.



4. Install the cellular module onto the socket and fasten the two screws on the module.

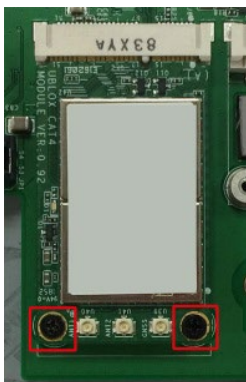

5. Connect the antenna cables to the antenna connectors.

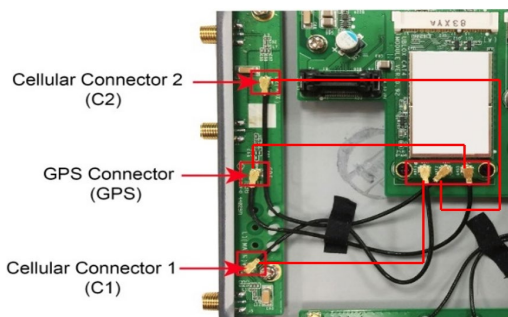

6. The UC-8220 Series supports two cellular antennas and a GPS antenna. Connect the cable to the correct antenna connectors.
7. When finished, place the side cover back on the computer and secure it.

Installing the Wi-Fi Module

The Wi-Fi module is not included in the package, you need to purchase separately. The Wi-Fi module package includes the following items:

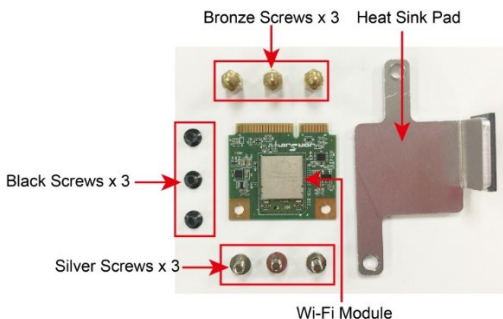

Follow these steps to install the Wi-Fi module.

1. Remove the side cover of the computer to expose the Wi-Fi module socket. The Wi-Fi socket is located beside the cellular module socket.



- Remove the two silver screws on the socket.
- Install the Wi-Fi module in the socket and fasten two black screws on the module. Also, fasten the two bronze screws on the board.

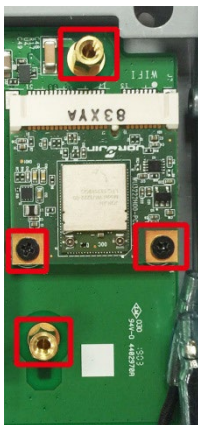
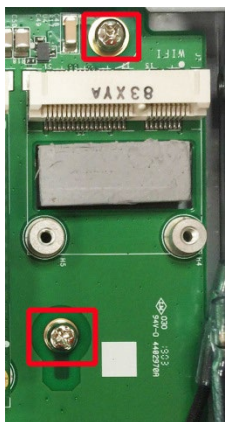

- Remove the plastic protection covers on the antenna connectors.



- Connect the antenna cables to the antenna connectors. The Wi-Fi module supports two antenna connectors, connect the cables to the correct antenna connectors.

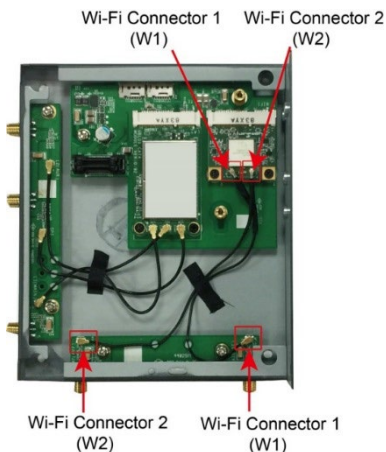

6. Install the heat sink pad on the module and then fasten two silver screws.

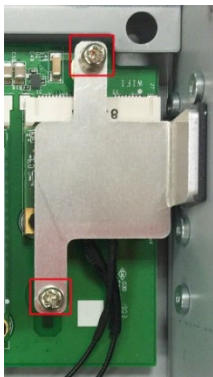

7. Replace the side cover.



Connecting Antennas

There are two cellular antenna connectors (C1 and C2) on the front panel of the UC-8220 Series. In addition, a GPS connector is provided for the GPS module. All three connectors are of SMA type. Connect the antennas to these connectors as shown below.

There are two Wi-Fi antenna connectors (W1 and W2) on the top panel of the UC-8220 Series. Connect the antennas on the connectors as shown below. Both W1 and W2 connectors are of RP-SMA type.



ATEX and C1D2 Specifications

Models	UC-8210-T-LX-S, UC-8220-T-LX, UC-8210-LX-S, UC-8220-LX
Rating	Input: 12 to 48 VDC; 1.0 to 0.25 A
ATEX Information	  II 3 G Certificate Number: DEMKO 19 ATEX 2302X Certification String: Ex nA IIC T4 Gc Ambient Range: $-40^{\circ}\text{C} \leq T_{\text{amb}} \leq 70^{\circ}\text{C}$ (with LTE module for model UC-8220-T-LX) Rated Cable Temp $\geq 100^{\circ}\text{C}$
C1D2 Information	Temperature Code (T-code): T4
Manufacturer's Address	No. 1111, Heping Rd., Bade Dist., Taoyuan City 334004, Taiwan
Hazardous Location Certification	EN 60079-0:2012+A11:2013/IEC 60079-0 Ed.6 EN 60079-15:2010/IEC 60079-15 Ed.4