

V2406C Hardware User's Manual

Version 2.0, January 2022

www.moxa.com/product



© 2022 Moxa Inc. All rights reserved.

V2406C Hardware User's Manual

The software described in this manual is furnished under a license agreement and may be used only in accordance with the terms of that agreement.

Copyright Notice

© 2022 Moxa Inc. All rights reserved.

Trademarks

The MOXA logo is a registered trademark of Moxa Inc.
All other trademarks or registered marks in this manual belong to their respective manufacturers.

Disclaimer

Information in this document is subject to change without notice and does not represent a commitment on the part of Moxa.

Moxa provides this document as is, without warranty of any kind, either expressed or implied, including, but not limited to, its particular purpose. Moxa reserves the right to make improvements and/or changes to this manual, or to the products and/or the programs described in this manual, at any time.

Information provided in this manual is intended to be accurate and reliable. However, Moxa assumes no responsibility for its use, or for any infringements on the rights of third parties that may result from its use.

This product might include unintentional technical or typographical errors. Changes are periodically made to the information herein to correct such errors, and these changes are incorporated into new editions of the publication.

Technical Support Contact Information

www.moxa.com/support

Moxa Americas

Toll-free: 1-888-669-2872
Tel: +1-714-528-6777
Fax: +1-714-528-6778

Moxa Europe

Tel: +49-89-3 70 03 99-0
Fax: +49-89-3 70 03 99-99

Moxa India

Tel: +91-80-4172-9088
Fax: +91-80-4132-1045

Moxa China (Shanghai office)

Toll-free: 800-820-5036
Tel: +86-21-5258-9955
Fax: +86-21-5258-5505

Moxa Asia-Pacific

Tel: +886-2-8919-1230
Fax: +886-2-8919-1231

Table of Contents

1. Introduction	1-1
Overview	1-2
Package Checklist	1-2
Product Features	1-2
Hardware Specifications	1-3
Hardware Block Diagram	1-3
2. Hardware Introduction	2-1
Appearance	2-2
Dimensions	2-3
LED Indicators	2-3
Real-time Clock	2-4
3. Hardware Connection Description	3-1
Installing the V2406C	3-2
Wiring Requirements	3-3
Connecting the Power	3-3
Grounding the Unit	3-4
Connecting Data Transmission Cables	3-5
Connecting to the Network	3-5
Connecting to a Serial Device	3-7
Connecting an Audio Input and Output	3-8
Digital Input/Output	3-8
Connecting to a VGA Monitor	3-9
Connecting to the USB Ports	3-10
Installing a Hot-swappable Storage Drive	3-10
Installing the SIM Cards	3-11
Installing the Wi-Fi Module	3-13
Installing the Cellular Module	3-15
Installing the Wireless Cables and Antennas	3-16
Switching the Wireless Module Socket	3-17
Installing the mSATA Drive	3-18
Upgrading the Memory	3-18
Replacing the Battery	3-20
4. BIOS Setup	4-1
Entering the BIOS Setup	4-2
Main Page	4-4
Advanced Settings	4-5
Boot Configuration	4-6
SATA Configuration	4-7
Intel Rapid Storage Technology	4-9
CPU Configuration	4-10
Active Management Technology Support	4-11
Video Configuration	4-12
Chipset Configuration	4-13
SIO ITE8786E	4-14
Console Redirection	4-15
Security Settings	4-16
Current TPM Device	4-16
TPM State	4-16
Clear TPM	4-16
Set Supervisor Password	4-17
Power Settings	4-19
Wake on LAN	4-19
Auto Wake on S5	4-19
mPCIe#1 Power	4-19
mPCIe#2 Power	4-19
Boot Settings	4-20
Boot Type	4-20
Network Stack	4-20
PXE Boot capability	4-20
USB Boot	4-21
Timeout	4-21
EFI	4-21
Secure Boot Settings	4-21
Enforce Secure Boot	4-23
Erase All Secure Boot Settings	4-23
Restore Secure Boot to Factory Settings	4-23
Enabling AMT	4-23

Exit Settings	4-26
Exit Saving Changes	4-27
Save Change Without Exit	4-27
Exit Discarding Changes	4-27
Load Optimal Defaults	4-27
Load Custom Defaults	4-27
Save Custom Defaults	4-27
Discard Changes	4-27
Remote Management Using AMT	4-28
Upgrading the BIOS	4-29

A. Regulatory Approval Statement A-1

Introduction

This chapter gives a general overview of the V2406C computer's hardware features and specifications.

The following topics are covered in this chapter:

- **Overview**
- **Package Checklist**
- **Product Features**
- **Hardware Specifications**
- **Hardware Block Diagram**

Overview

The V2406C Series embedded computers are based on the Intel® 7th and 8th Gen processors and feature 4 RS-232/422/485 serial ports, dual LAN ports, and 4 USB 3.0 hosts. In addition, the computers provide 1 VGA output and 1 HDMI display with 4k resolution support. The computers comply with the EN 50155:2017 specifications covering operating temperature, power input voltage, surge, ESD, and vibration, making them suitable for a variety of industrial applications.

The mSATA socket, SATA connectors, and USB sockets provide the V2406C computers with the reliability needed for industrial applications that require data buffering and storage expansion. The computers also come with 2 hot-swappable storage trays for inserting additional storage media, such as hard disk or solid-state drives, and support hot swapping for convenient, fast, and easy storage replacement. Each storage tray has its own LED to indicate whether or not a storage module is plugged in.

Package Checklist

The following items are included in the package.

- V2406C embedded computer
- Wall-mounting kit
- 2 HDD trays
- 8 screws for hot-swappable HDD trays
- HDMI cable locker
- Quick installation guide (printed)
- Warranty card

NOTE: Please notify your sales representative if any of the above items are missing or damaged.

Product Features

- Intel® Celeron®/Intel® Core™ i3/i5/i7 high performance network video recorder for rolling stock applications
- Two hot-swappable trays for 2.5-inch HDD/SSD storage expansion
- API library for easy deployment and storage volume notification
- 4K resolution HDMI display
- 2 Gigabit Ethernet ports with M12 X-coded push-pull connectors
- M12 A-coded power connector
- Compliance with EN 50155:2017 and EN 50121-4 standards
- IEC 61373 certification for shock and vibration resistance
- -40 to 70°C wide temperature models available

*This product is suitable for rolling stock railway applications, as defined by the EN 50155 standard. For a more detailed statement, click here: www.moxa.com/doc/specs/EN_50155_Compliance.pdf

Hardware Specifications

For the product hardware specifications, refer to Moxa's website: <https://moxa.com>.

Hardware Block Diagram

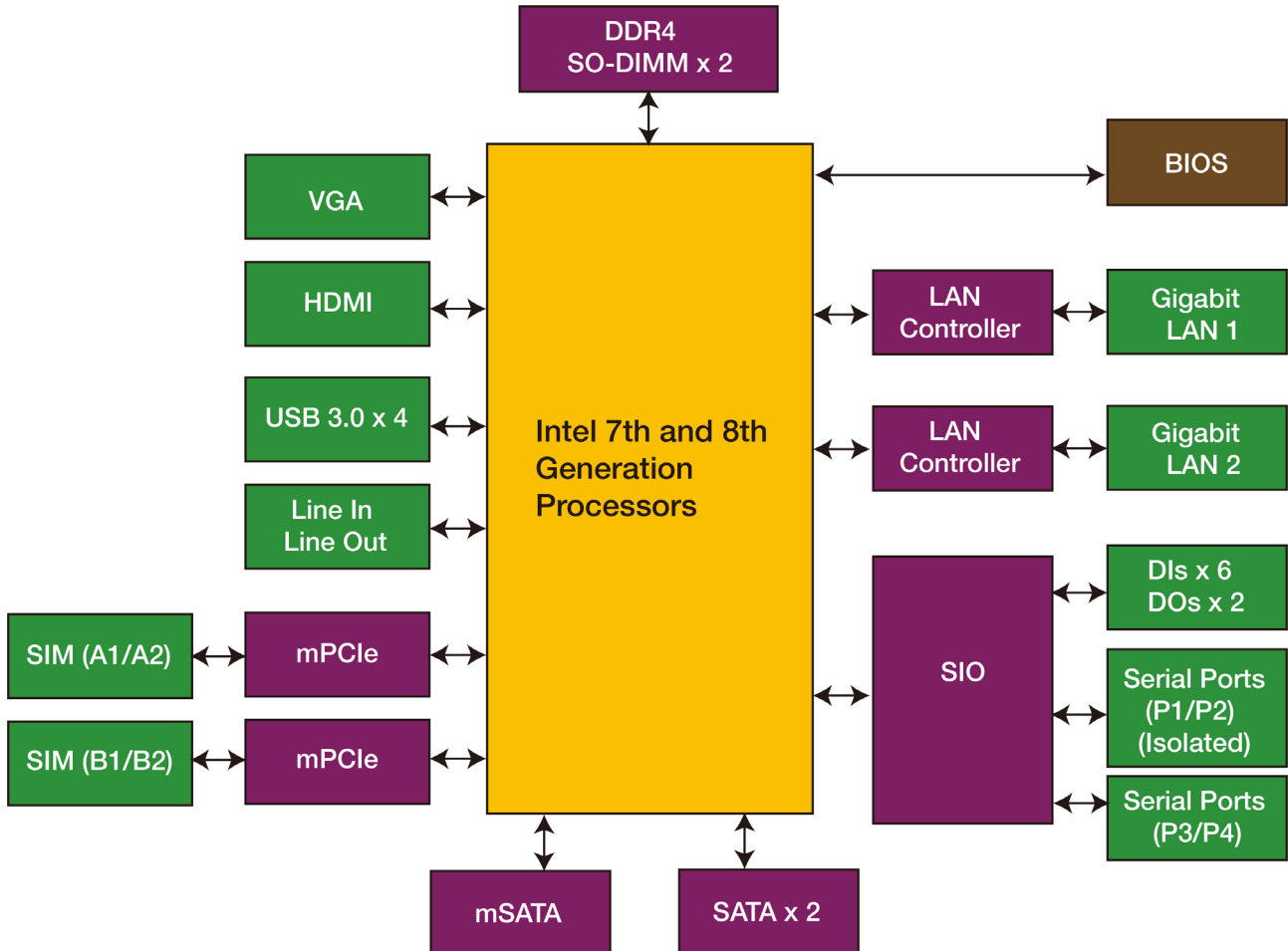

Hardware Introduction

V2406C embedded computers are compact and rugged for use in industrial applications. LED indicators help you monitor performance and identify trouble spots, multiple serial ports allow you to connect a variety of devices for wireless operation, and the reliable and stable hardware platform lets you devote your attention to developing your applications, rather than diddling with low-level APIs and device drivers.

The following topics are covered in this chapter:

- **Appearance**
- **Dimensions**
- **LED Indicators**
- **Real-time Clock**

Appearance

Front View

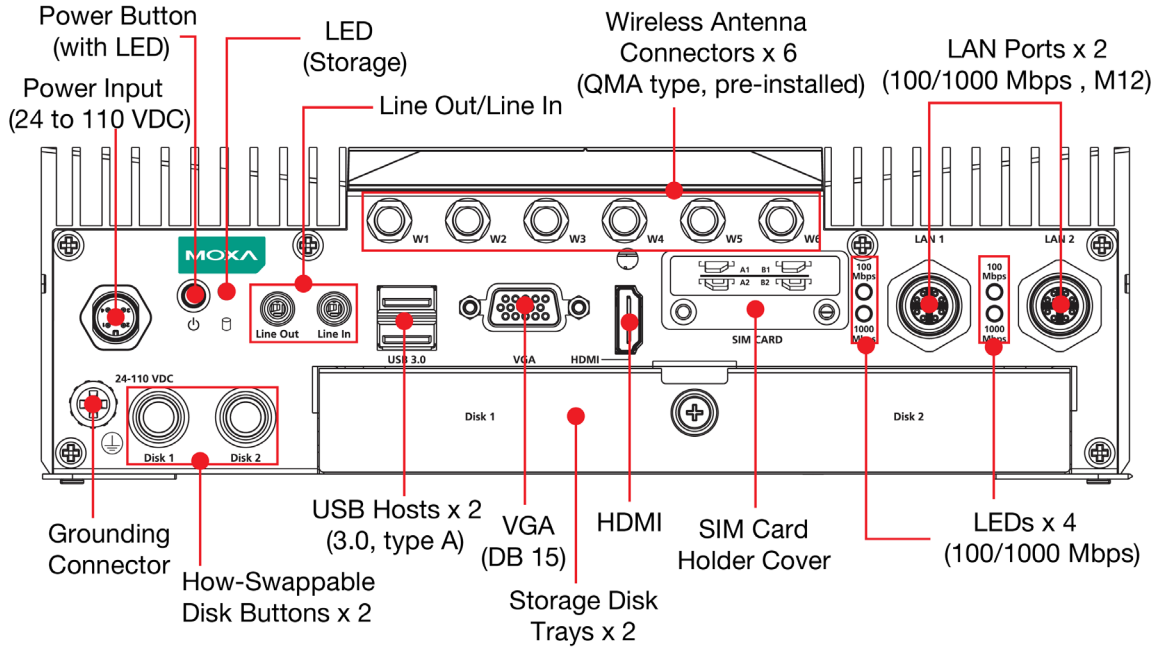

Rear View

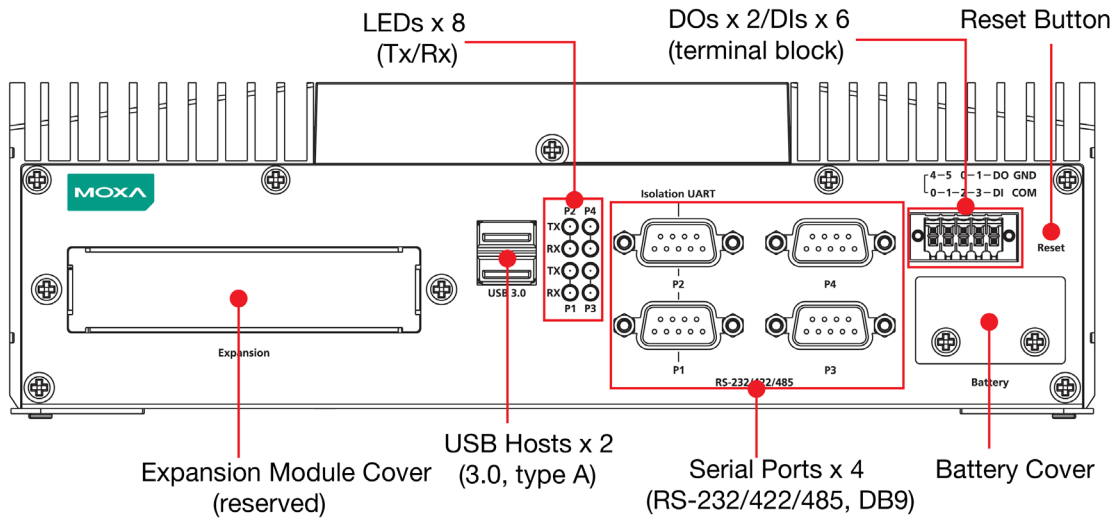

Dimensions

Unit: mm (inch)

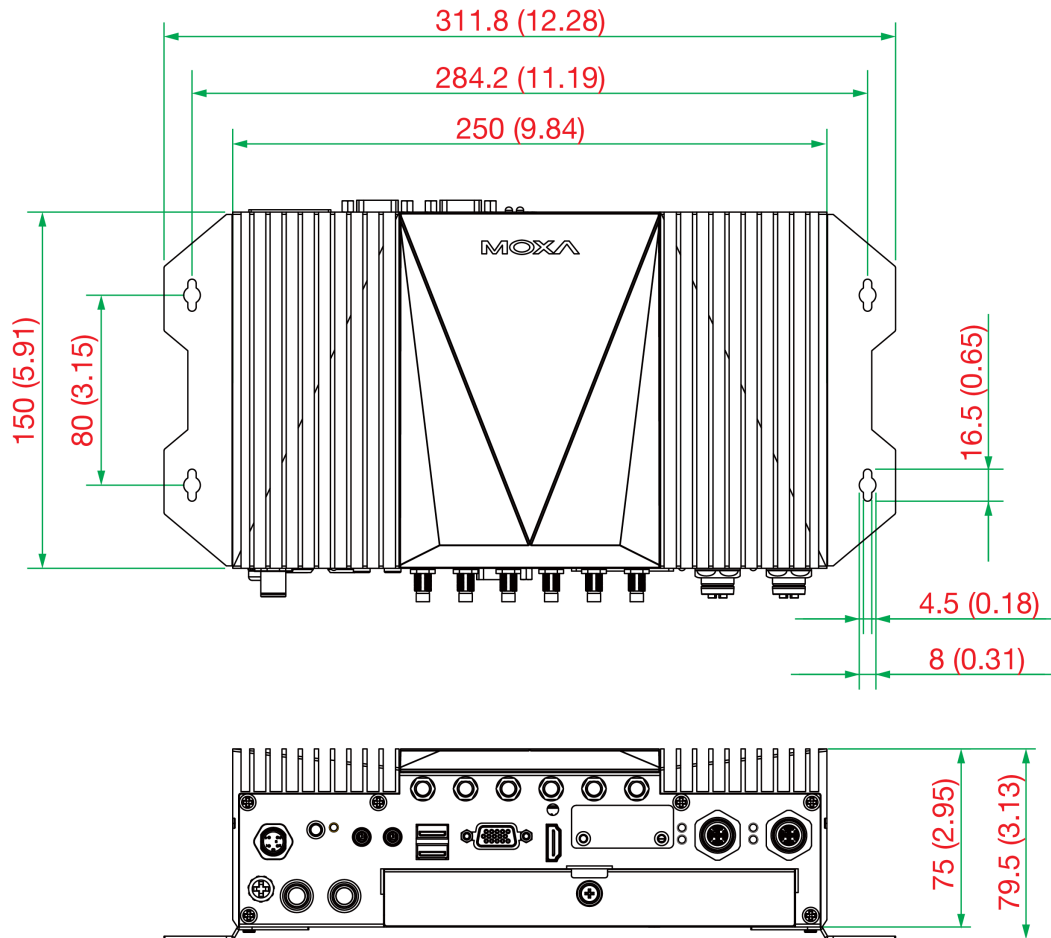

LED Indicators

LED Name	Status	Function
Power (on Power Button)	Green	Power is on
	Off	No power input
Ethernet (100 Mbps) (1000 Mbps)	Green	Steady On: 100 Mbps Ethernet link Blinking: Data transmission is in progress
	Yellow	Steady On: 1000 Mbps Ethernet link Blinking: Data transmission is in progress
	Off	Data transmission speed at 10 Mbps or the cable is not connected
Serial ┌ Tx └ Rx	Green	Tx: Data transmission is in progress
	Yellow	Rx: Receiving Data
	Off	No operation
Storage	Yellow	Data is being accessed from either the mSATA or the SATA drive
	Off	Data is not being accessed from the storage drives

Real-time Clock

The embedded computer's real-time clock is powered by a lithium battery. We strongly recommend that you **NOT** replace the lithium battery on your own. If the battery needs to be changed, contact the Moxa RMA service team.



ATTENTION

There is a risk of explosion if the wrong type of battery is used. To avoid this potential danger, always be sure to use the correct type of battery. Contact the Moxa RMA service team if you need to replace your battery.

Caution

Dispose of used batteries in a suitable manner. Consult the battery manufacturer for details on disposing batteries.

Hardware Connection Description

In this chapter, we show how to connect the embedded computers to the network and to a variety of common devices.

The following topics are covered in this chapter:

- ❑ **Installing the V2406C**
- ❑ **Wiring Requirements**
 - Connecting the Power
 - Grounding the Unit
- ❑ **Connecting Data Transmission Cables**
 - Connecting to the Network
 - Connecting to a Serial Device
- ❑ **Connecting an Audio Input and Output**
- ❑ **Digital Input/Output**
- ❑ **Connecting to a VGA Monitor**
- ❑ **Connecting to the USB Ports**
- ❑ **Installing a Hot-swappable Storage Drive**
- ❑ **Installing the SIM Cards**
- ❑ **Installing the Wi-Fi Module**
- ❑ **Installing the Cellular Module**
- ❑ **Installing the Wireless Cables and Antennas**
- ❑ **Switching the Wireless Module Socket**
- ❑ **Installing the mSATA Drive**
- ❑ **Upgrading the Memory**
- ❑ **Replacing the Battery**

Installing the V2406C

Wall or Cabinet Mounting

The V2406C comes with two wall-mounting brackets. Use four screws per side to attach the mounting bracket to the computer. Ensure that the mounting brackets are attached to the V2406C computer in the direction shown in the following figure.

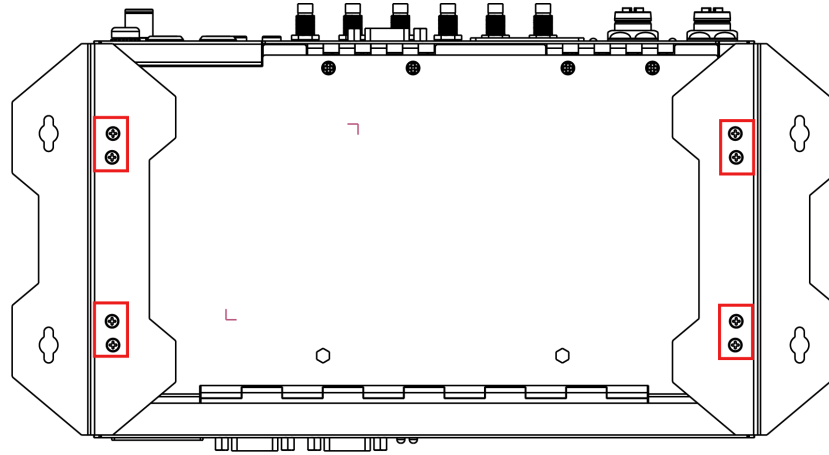

The eight screws are included in the package. They are standard IMS_M3x5L screws and require a torque of 4.5 kgf-cm. Refer to the following illustration for details.

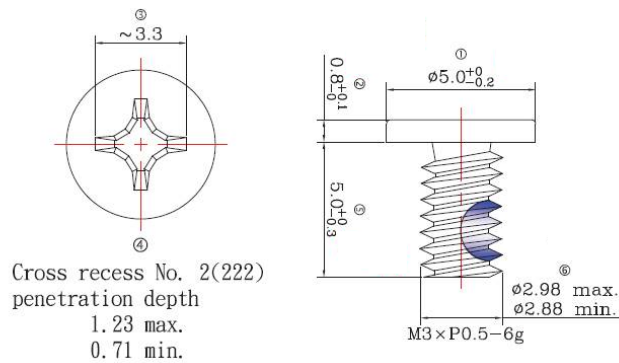

Use two screws (M3*5L standard is recommended) per side to attach the V2406C computer to a wall or a cabinet. The product package does not include the four screws required for attaching the wall-mounting kit to the wall; they need to be purchased separately. Ensure that the V2406C computer is installed in the direction shown in the following figure.

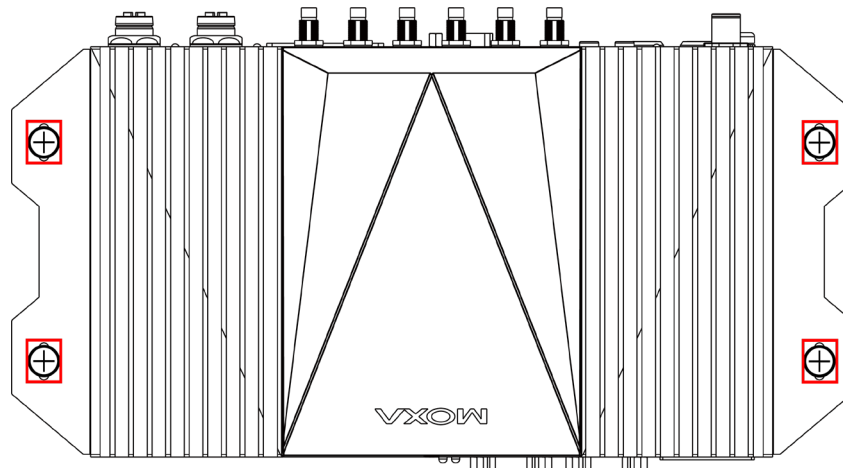

Wiring Requirements

This section describes how to connect peripheral devices to the embedded computer.

You should read and follow these common safety precautions before proceeding with the installation of any electronic device:

- Use separate paths to route wiring for power and devices. If power wiring and device wiring paths must cross, make sure the wires are perpendicular at the intersection point.



ATTENTION

Do not run signal or communication wiring together with power wiring in the same wire conduit. To avoid interference, wires with different signal characteristics should be routed separately.

- Use the type of signal transmitted through a wire to determine which wires should be kept separate. The rule of thumb is that wiring that shares similar electrical characteristics can be bundled together.
- Keep input wiring and output wiring separate.
- It is advisable to label the wiring to all devices in the system.



ATTENTION

Safety First!

Be sure to disconnect the power cord before installing and/or wiring your V2406C.

Wiring Caution!

Calculate the maximum possible current in each power wire and common wire. Observe all electrical codes dictating the maximum current allowable for each wire size.

If the current goes above the maximum ratings, the wiring could overheat, causing serious damage to your equipment.

Temperature Caution!

Be careful when handling the unit. When the unit is plugged in, the internal components generate heat, and consequently the outer casing may feel hot to the touch.

Connecting the Power

Connect the 24 to 110 VDC power line with M12 connector to the V2406C computer. If the power is supplied properly, the **Ready** LED will glow a solid green after a 25 to 30 second delay.

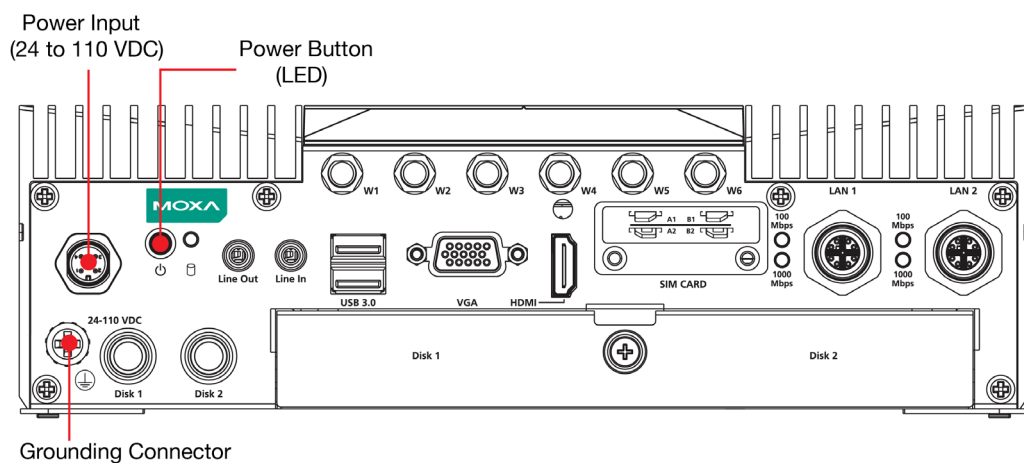

Pin	Definition
1	V+
2	N.C.
3	V-
4	N.C.

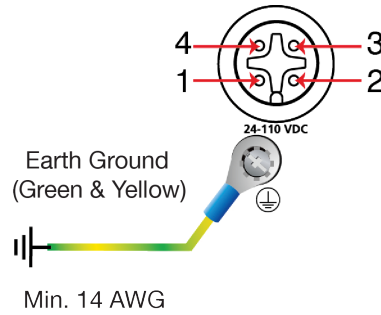

The power input specification is given below:

- DC mains with a power source rating of 24 V @ 2.74 A; 100 V @ 0.584 A, and a minimum of 14 AWG.



ATTENTION

For safety reason, refer to the following instructions on power input installation.

1. The power switch or circuit breaker between Moxa’s products and the power supply should easily disconnect if a power overcurrent occurs.
2. The maximum branch circuit over current protection rate should be 20 A.
3. The DC power source wire specifications should include minimum 14 AWG and compliance with VW-1 or FT-1 standards.

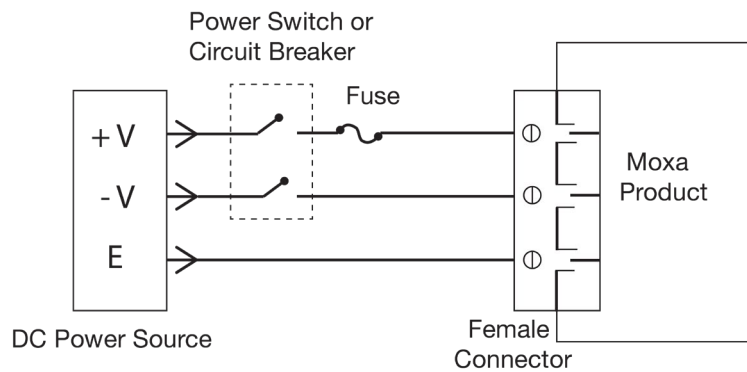

For surge protection, connect the grounding connector located below the power connector with the earth (ground) or a metal surface.

Grounding the Unit



In addition, a grounding connector is also provided below the power input connector. Connect the wire to an appropriately grounded metal surface.

Connecting Data Transmission Cables

This section describes how to connect V2406C embedded computers to a network and serial devices.

Connecting to the Network

Two 10/100/1000 Mbps Ethernet ports using M12 X-coded connectors are located on the rear panel of the computer.



ATTENTION

There is risk of damage to the M12 X-coded cable due to improper installation or removal. Before you attach an M12 X-coded cable to an Ethernet port on the V2406C, read the instructions carefully. The M12 X-coded cable is designed with locking mechanisms to prevent pin misalignment. Make sure that you properly align the indicator and notches when connecting the cable. Do NOT insert the cable into a port with excessive force.

Refer to the following figure for the specific location of the Ethernet ports.

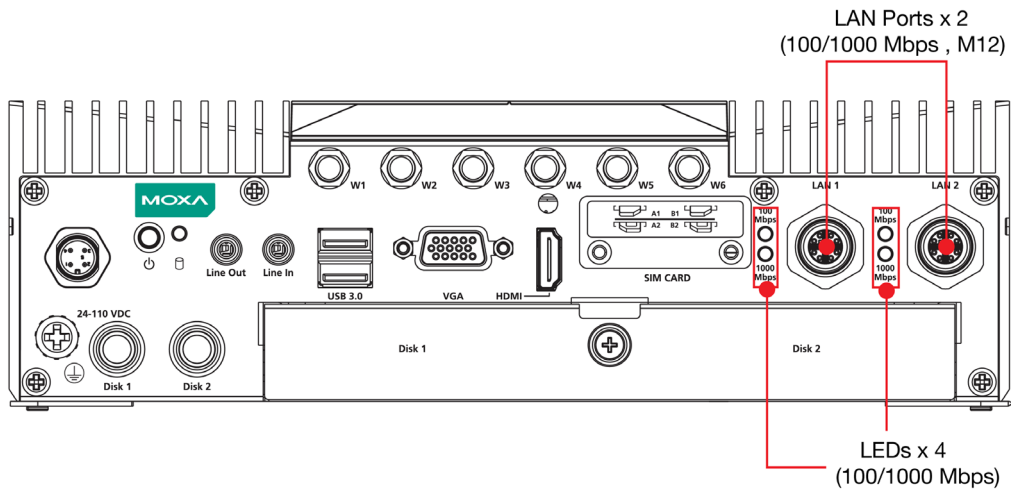

Refer to the following figure for the pin assignments of the Ethernet ports.

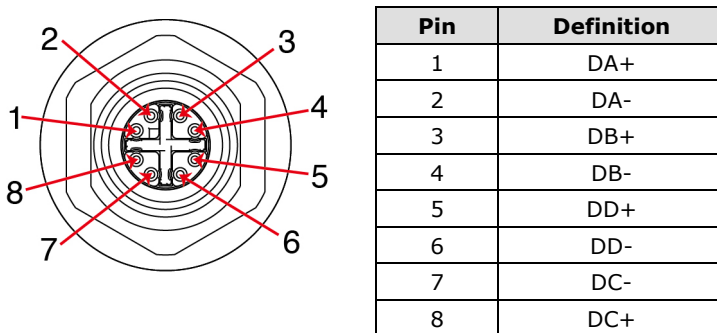

Follow the steps below to connect an M12 X-coded cable to the computer:

1. Obtain an M12 X-coded cable.
The following table shows the Ethernet connector and cable options. For more information, contact your local Moxa sales representative.

Model Name	Type	Description
CBL-M12XMM8PRJ45-BK-100-IP67	Cable and connector	1-meter X-coded M12-to-RJ45 Cat-5E UTP Gigabit Ethernet cable, 8-pin male M12 connector, IP67-rated.
M12X-8PMM-IP67	Connector	Field-installation X-coded screw-in Gigabit Ethernet connector, 8-pin male, M12 connector, IP67-rated.

NOTE For best performance and transmission quality, Moxa strongly recommends that you use cables and connectors from Phoenix Contact.

- Align the notch on the M12 X-coded cable pin core with the notch on the port socket.

Pin assignment of M12 plug. 8-pos., X-coded, pin side view

M12 socket pin assignment 8-pos, socket side view

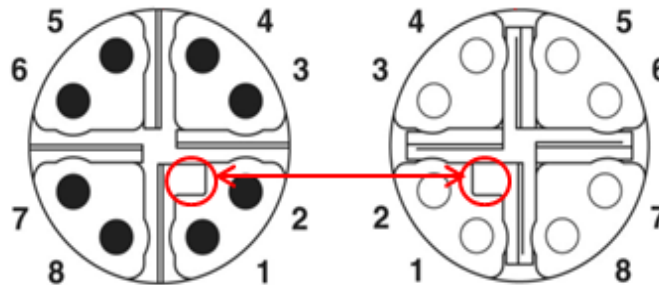

- Connect the M12 X-coded cable to the port.

NOTE Do NOT use excessive force to push the M12 X-coded cable into the port

- Turn the interlock screw to tighten it over the cable without using a mechanical tool (such as a screw wrench).



Connecting to a Serial Device

The V2406C comes with four serial ports, which can be configured for RS-232/422/485 interfaces. These ports are located on the front panel. Port 1 and Port 2 are isolated UART ports.

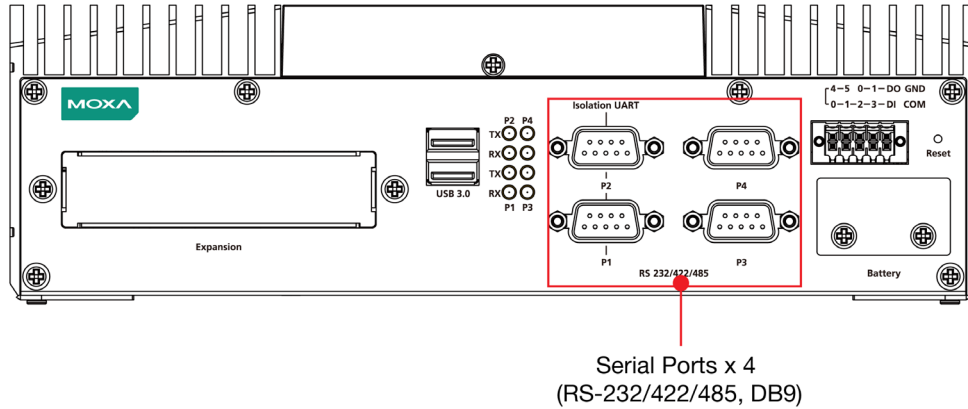

Use a serial cable to connect your serial device to the embedded computer’s serial port. These ports have male DB9 connectors and can be configured for RS-232, RS-422, or RS-485 using the software. The pin assignments of the ports are shown in the table below:

DB9 Male Port

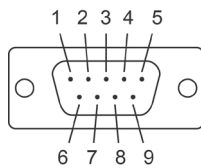

RS-232/422/485 Pinouts

Pin	RS-232	RS-422	RS-485-4W	RS-485-2W
1	DCD	TxDA(-)	TxDA(-)	-
2	RxD	TxDB(+)	TxDB(+)	-
3	TxD	RxDB(+)	RxDB(+)	DataB(+)
4	DTR	RxDA(-)	RxDA(-)	DataA(-)
5	GND	GND	GND	GND
6	DSR	-	-	-
7	RTS	-	-	-
8	CTS	-	-	-

NOTE This is the pin assignment for the computer-side connectors on the V2406C. If you are wiring peripheral-side connectors for a serial cable, you will need to match the pin assignment of the connectors.

Connecting an Audio Input and Output

The V2406C comes with a Line-in and a Line-out with 35 mm jack plug connectors, allowing users to connect a speaker or an earphone.

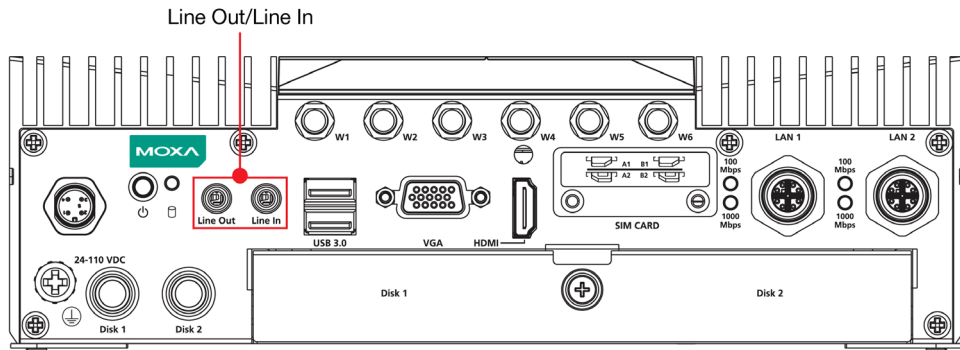

Digital Input/Output

The V2406C comes with a 6-channel digital input and a 2-channel digital output through a terminal block connector.

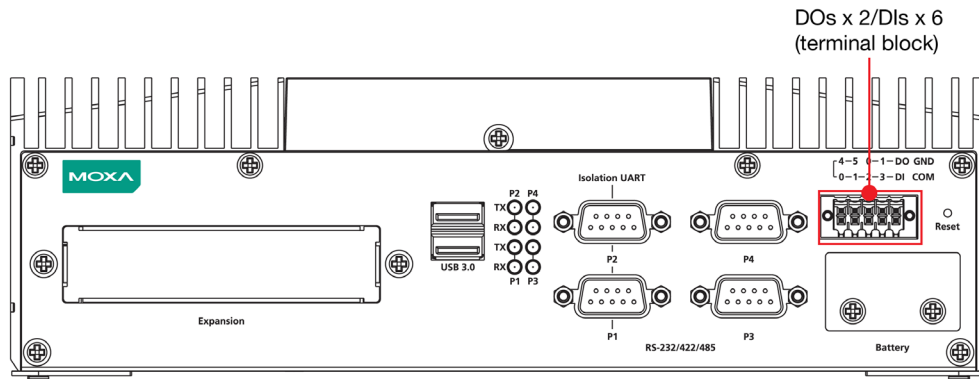

Refer to the following figures for the pin definitions and the current ratings.

4-5 0-1 – DO GND
0-1-2-3 – DI COM

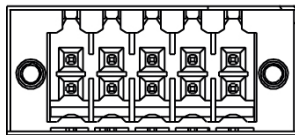

Digital Inputs

Dry Contact
Logic 0: Short to Ground
Logic 1: Open
Wet Contact (DI to COM)
Logic 1: 10 to 30 VDC
Logic 0: 0 to 3 VDC

Digital Outputs

Current Rating: 200 mA per channel
Voltage: 24 to 30 VDC

The wiring methods are shown in the diagram below:

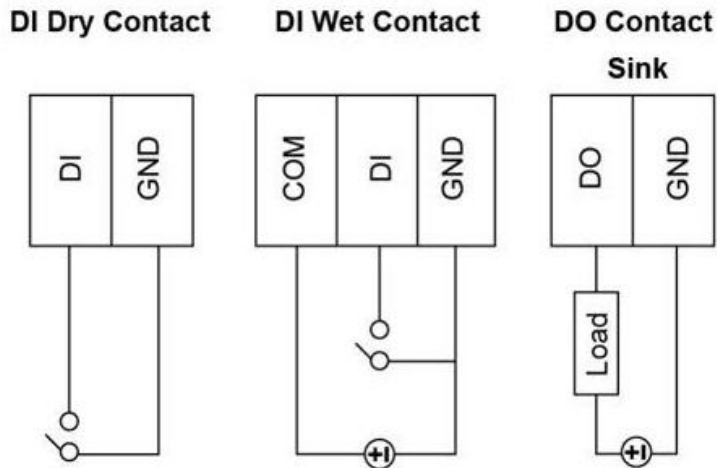

NOTE If you are using wet contacts, you must connect the source to power. In addition, both DI and DO can only be wired as sink types.

Connecting to a VGA Monitor

The V2406C comes with a D-Sub 15-pin female connector on the rear panel to connect a VGA monitor. To ensure that the monitor image remains clear, tighten the monitor cable after connecting it to the V2406C. The pin assignments of the video output connector are shown in the diagram below:

DB15 Female Connector

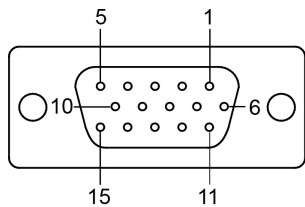

Pin No.	Signal Definition	Pin No.	Signal Definition
1	Red	9	VCC
2	Green	10	GND
3	Blue	11	NC
4	NC	12	DDC2B Data
5	GND	13	HSYNC
6	GND	14	VSYNC
7	GND	15	DDC2B Clock
8	GND		

In addition, an HDMI connector is also provided on the rear panel, allowing users to connect another display with an HDMI interface.

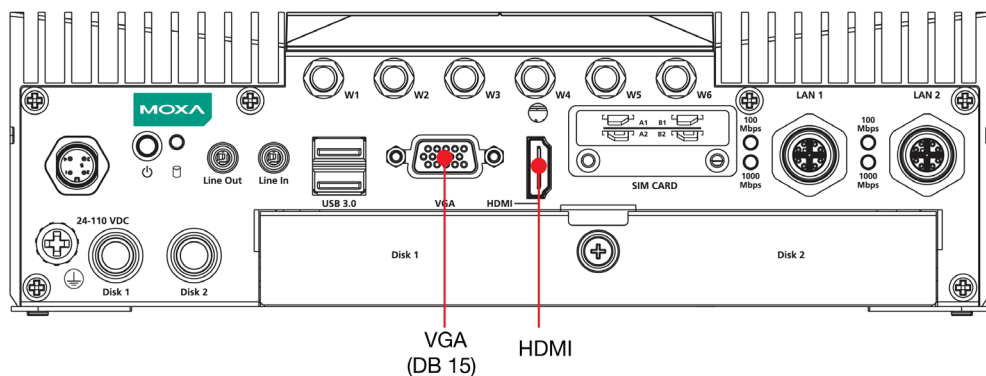

NOTE In order to have a highly reliable video streaming capability, choose HDMI-certified HDMI cables.

Connecting to the USB Ports

The V2406C comes with four USB ports, two on the front panel, another two on the rear panel. All four ports come with USB 3.0 type A interfaces. Refer to the following illustrations for the location of these ports.

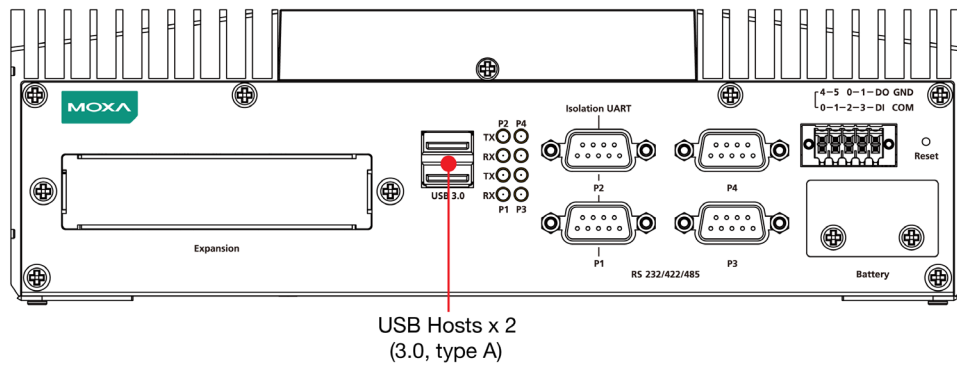
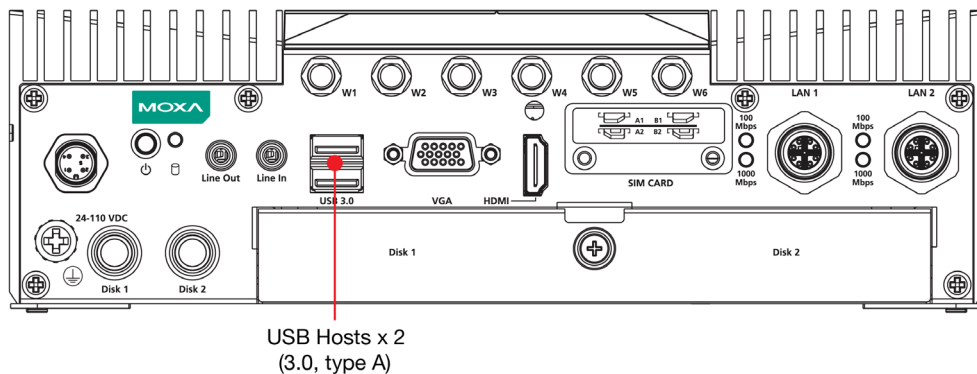

You can use these USB ports to connect various peripheral devices, such as a keyboard, a mouse, and USB storage disks, to your computer.

Installing a Hot-swappable Storage Drive

The V2406C comes with two storage sockets, allowing users to install two disks for data storage.

Follow these steps to install a hard disk drive.

1. Unpack the storage disk tray.
2. Place the disk drive on the tray.

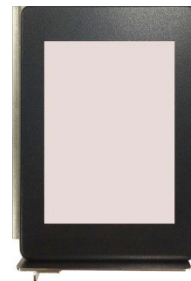

- Turn the tray and disk arrangement around so that the back side of the tray is facing you. Fasten the four screws to secure the disk to the tray.



- Unfasten the screw on the storage slot cover and pull down the cover to access the slot.



- Find the location of the storage tray rail inside the socket.



- Align the tray with the rail and insert the tray into the socket. To take out the tray, pull the clutch in the tray to your right and pull out the tray.



Installing the SIM Cards

The V2406C comes with 2 sockets, allowing users to install Wi-Fi or cellular modules. To install the cellular module, you need to install the SIM card first. Follow these steps.

- Find the SIM card holder cover on the front panel.

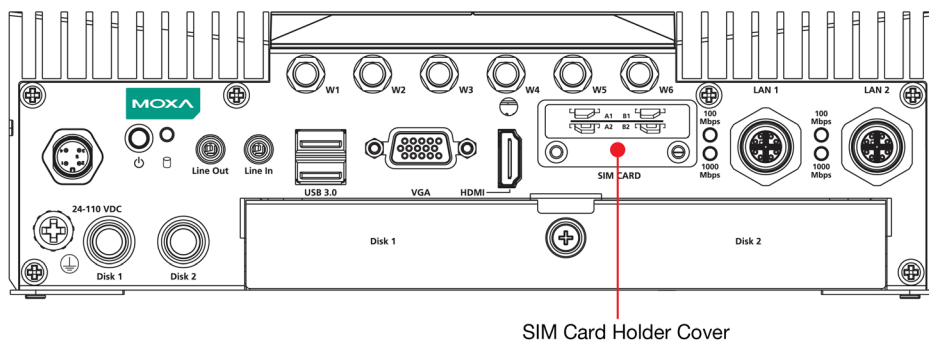

- Unfasten the two screws on the cover and remove the cover.

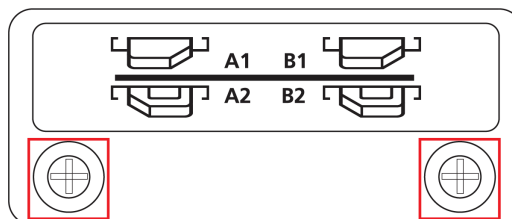

SIM CARD

Each cellular module supports dual SIM cards and microSIM card type is also supported. Check the following diagram for the location of the SIM card slots.

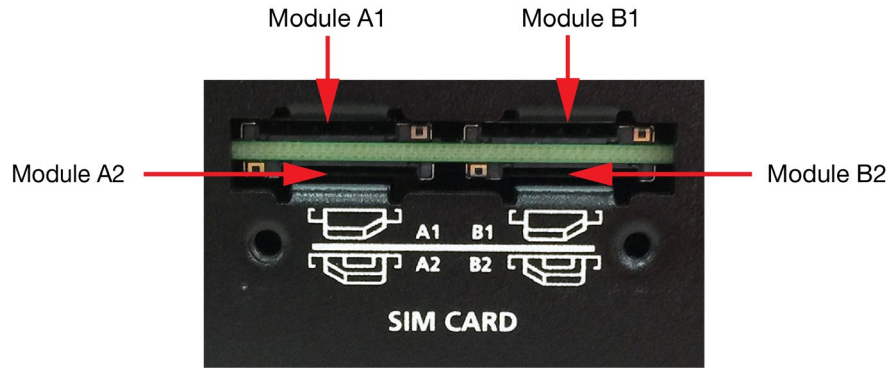

3. Check the illustration icon on the panel next to the slots and insert the SIM card(s) in the correct direction.

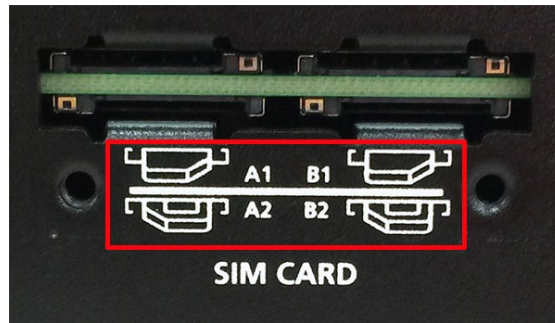

Inserting the SIM cards incorrectly may damage the slot and the SIM card. Check the following diagrams to confirm that the SIM card is inserted correctly into the slots.

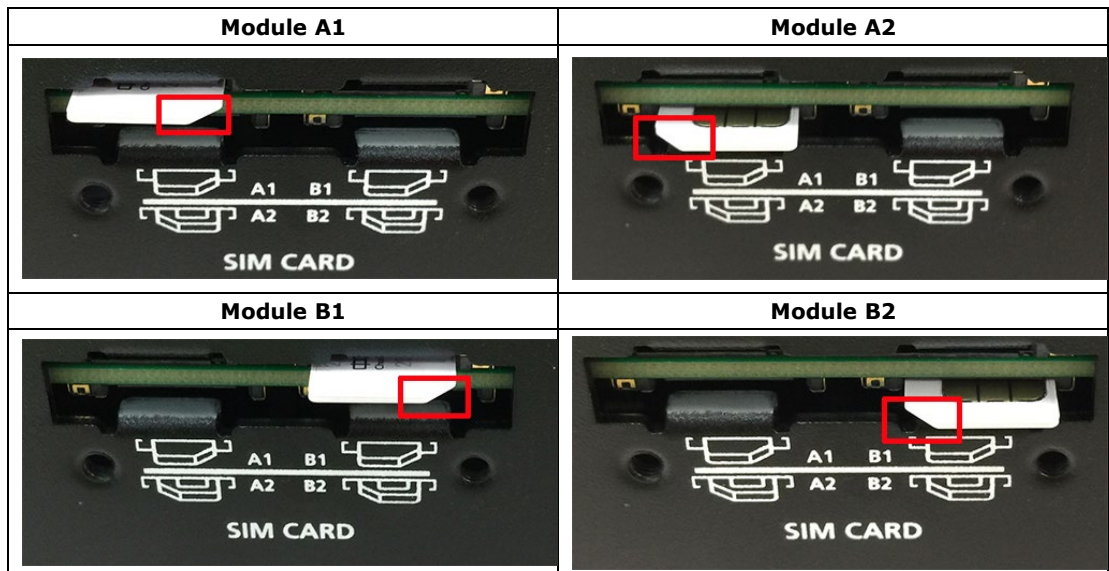

To remove the SIM card, simply push in the SIM card to release it and pull out the SIM card.

4. Replace the cover on the SIM card slot.

Installing the Wi-Fi Module

Follow these steps to install the Wi-Fi Module.

1. Remove the wall-mounting kit brackets.

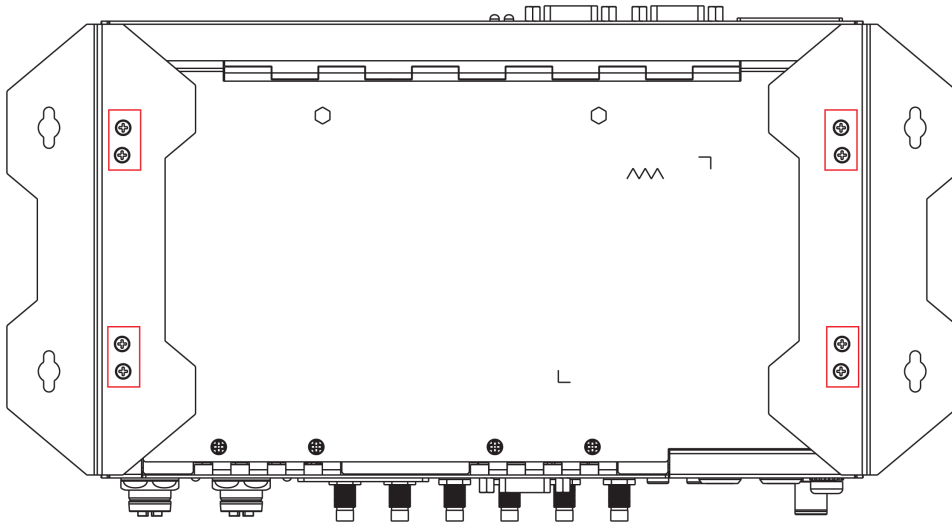

2. Remove the four screws on the bottom panel of the computer.

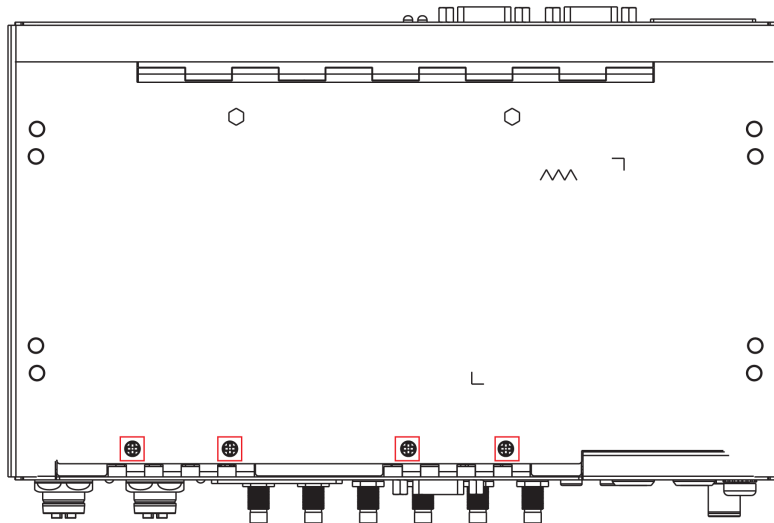

3. Take out the bottom cover of the computer, and find the location of the Wi-Fi module sockets. There are two sockets; you can install your Wi-Fi module on either one.

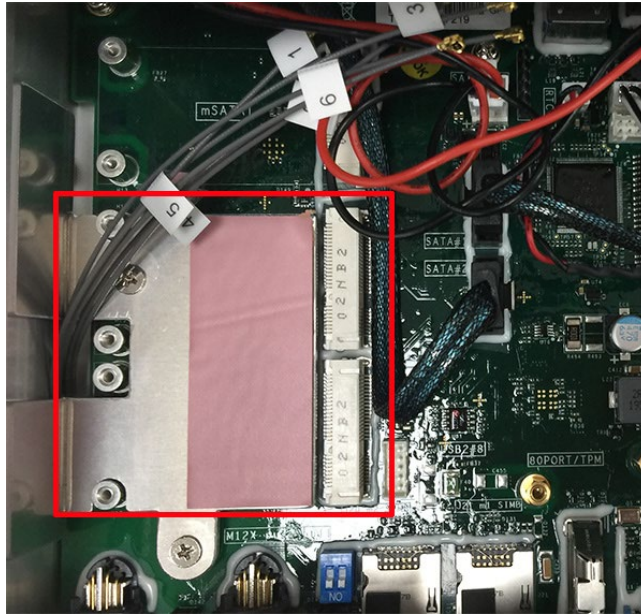

4. Check the Wi-Fi module package contents.

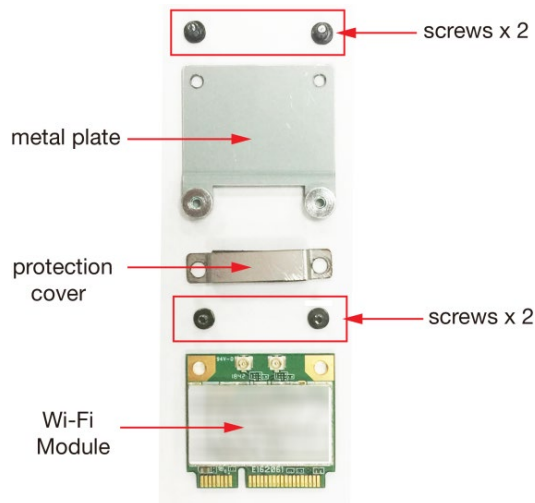

5. Install the metal plate and secure it with the two screws in the package.

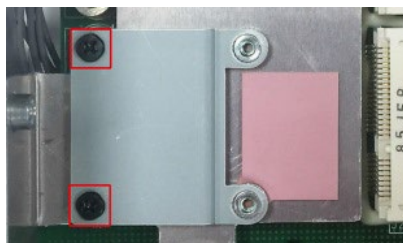

- Place the Wi-Fi module in the socket and connect the antenna cables to the connectors.

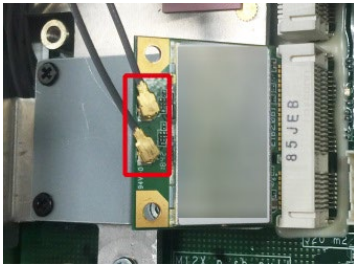

- Place the protection cover on the antenna cable connectors and secure the cover with the two screws in the package.

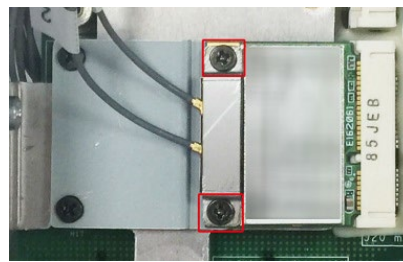

Installing the Cellular Module

Follow these steps to install the cellular module on the computer.

- Check the contents of the cellular module package.

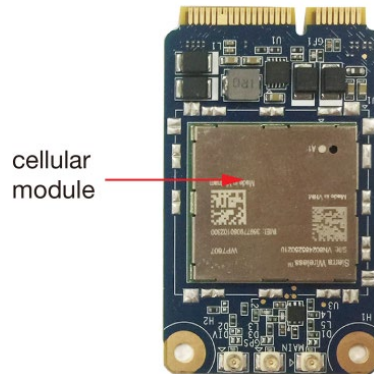

- Insert the module in the socket and secure it with the two screws in the package.
- Connect the three antenna cables on the connectors.

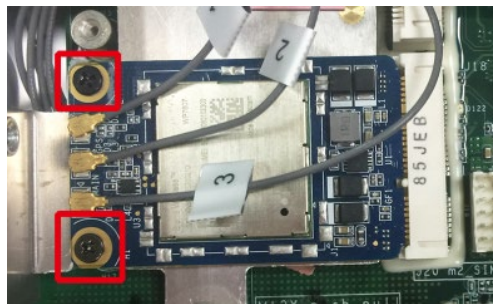

Note that there are three antenna connectors on the cellular module: one for GPRS and two for cellular communication.

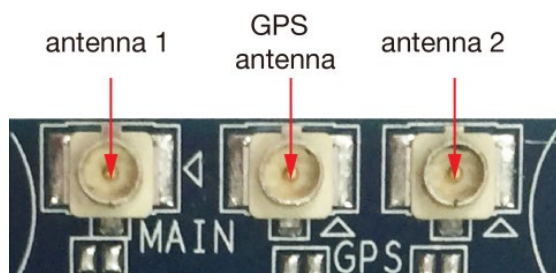

Installing the Wireless Cables and Antennas

Follow these steps to connect the wireless cables and antennas.

1. Identify the cables inside the computer.

There are six cables for connecting the wireless modules as indicated by the stickers in the following diagram.

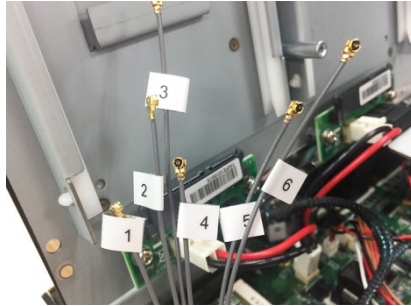

2. Connect the antennas to the correct connectors on the front panel of the computer.

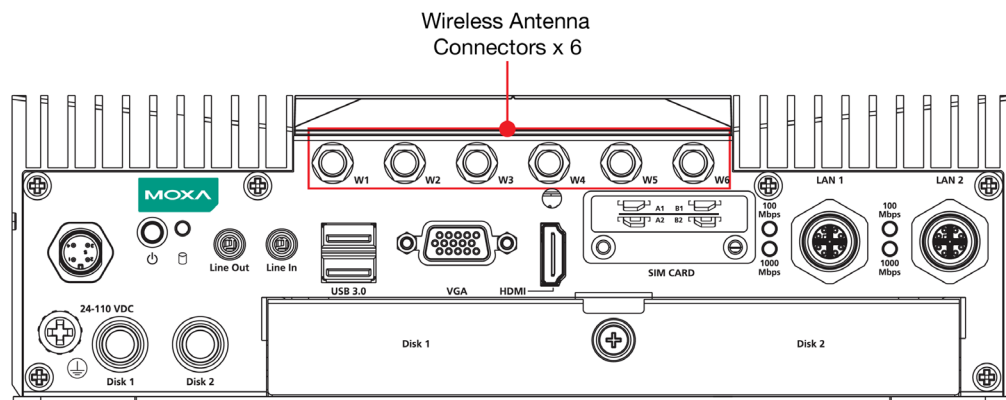

3. There are two methods to connect the antenna.
 - a. Connect a compatible connector first, and then attach the antenna.



b. Use an extension cord and then connect the antenna.



Switching the Wireless Module Socket

As there are two wireless module sockets and you can install the Wi-Fi or the cellular module on either of the sockets, a DIP switch is provided to enable selection of the Wi-Fi or cellular module. The DIP switch is located below the wireless module socket as shown in the following illustration.

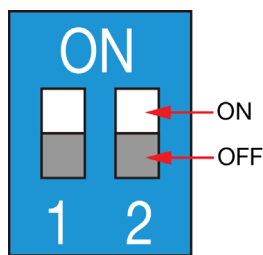
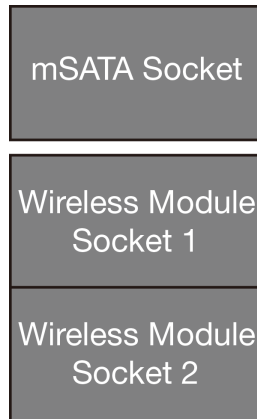

Status	Socket 1	Socket 2
ON (default)	Wi-Fi	Wi-Fi
OFF	Cellular	Cellular

For example, if you install the Wi-Fi module on the first socket, you need to turn to ON mode on the DIP switch.

Installing the mSATA Drive

There is an mSATA socket inside the computer; users can install the mSATA on their own for storage capacity expansion. The socket is located beside the wireless module sockets as indicated in the following diagram.



Insert the mSATA module into the socket, and fasten two screws to secure the module.

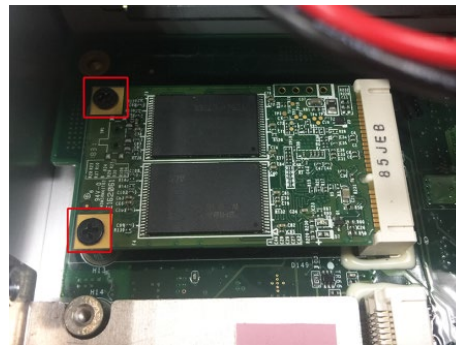

Upgrading the Memory

The V2406C comes with 2 DDR4 2400 SO-DIMM slots, with 8 GB memory preinstalled on one slot. To upgrade or replace the memory, follow these steps.

1. Remove the screw on the rear panel and take off the front cover.

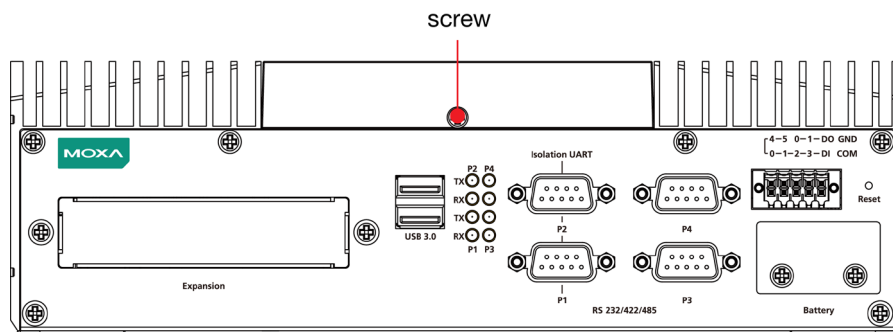

An 8-GB memory is preinstalled in the first slot.

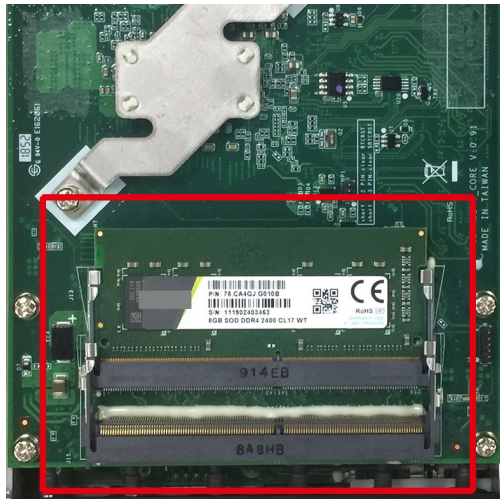

2. Push the two clutches on both sides of the memory card outwards and remove the memory card.



3. Insert the new memory card, pull in the clutches, and push down the memory card.



Ensure that the memory card is securely inserted.



4. Replace the cover to complete the memory upgrade and installation process.

Replacing the Battery

The V2406C comes with one battery slot containing a lithium battery with the specifications 3V/195 mAh. To replace the battery, do the following:

1. The battery cover is located on the front panel of the computer.

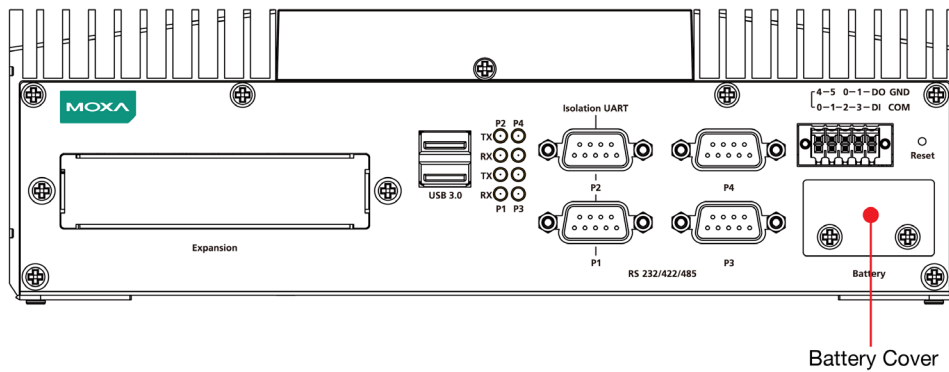

2. Unfasten the two screws on the battery cover.

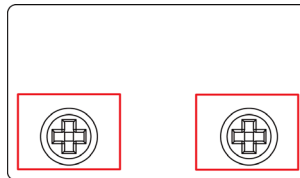

Battery

3. Remove the cover.
The battery is attached to the cover.

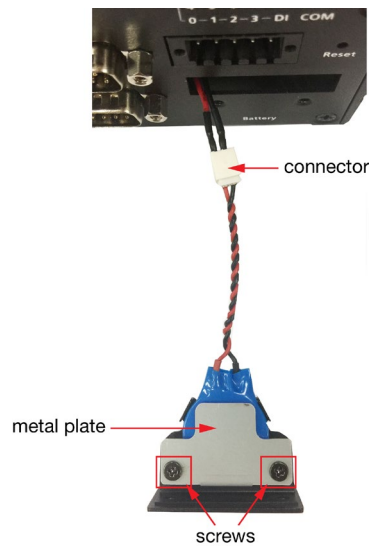

4. Separate the connectors and remove the two screws on the metal plate.



5. Replace the battery, place the metal plate on the battery, and fasten the screws to secure the batteries.
6. Reconnector the connectors, place the battery into the slot, and put back the cover.

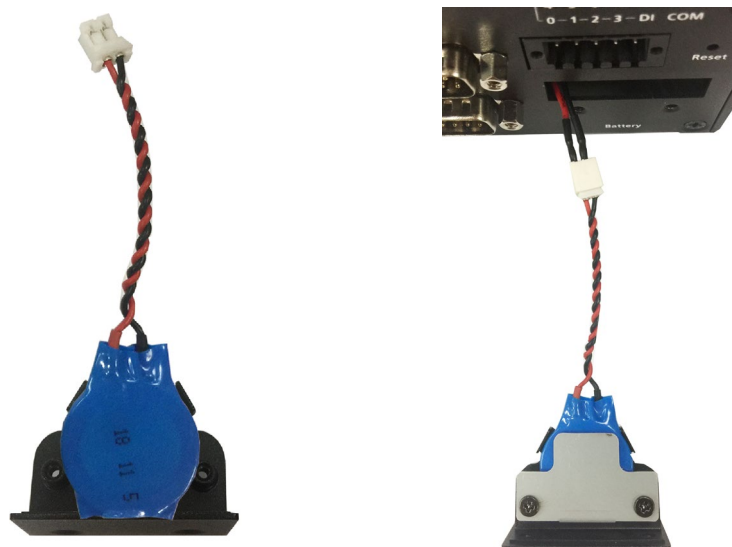

7. Secure the cover with the two screws.

NOTE Make sure you use the correct type of battery. Incorrect battery may cause system damage. Contact Moxa's technical support staff for assistance, if necessary.

NOTE This computer is intended to be installed in a restricted access area only. In addition, for safety reasons, the computer should be installed and handled only by qualified and experienced professionals.

NOTE This computer is designed to be supplied by listed equipment and rated 24 to 110 VDC, minimum 2.74 to 0.584 A, minimal Tma=70°C. If you need assistance with purchasing a power adapter, contact Moxa technical support team..

BIOS Setup

In this chapter, we describe the V2406C computer's BIOS settings. The BIOS is a set of input/output control routines for peripherals. The BIOS is used to initialize basic peripherals and help boot the operating system before the operating system is loaded. The BIOS setup allows the user to modify the system configurations of these input/output peripherals. The configuration settings are stored in the CMOS RAM, which receives power from a backup battery when the computer is not receiving power from an external power source. The system information is retained even after the system reboots or the power is disconnected.

The following topics are covered in this chapter:

❑ Entering the BIOS Setup

❑ Main Page

❑ Advanced Settings

- Boot Configuration
- SATA Configuration
- Intel Rapid Storage Technology
- CPU Configuration
- Active Management Technology Support
- Video Configuration
- Chipset Configuration
- SIO ITE8786E
- Console Redirection

❑ Security Settings

- Current TPM Device
- TPM State
- Clear TPM
- Set Supervisor Password

❑ Power Settings

- Wake on LAN
- Auto Wake on S5
- mPCIe#1 Power
- mPCIe#2 Power

❑ Boot Settings

- Boot Type
- Network Stack
- PXE Boot capability
- USB Boot
- Timeout
- EFI

❑ Secure Boot Settings

- Enforce Secure Boot
- Erase All Secure Boot Settings
- Restore Secure Boot to Factory Settings

❑ Enabling AMT

❑ Exit Settings

- Exit Saving Changes
- Save Change Without Exit
- Exit Discarding Changes
- Load Optimal Defaults
- Load Custom Defaults
- Save Custom Defaults
- Discard Changes

❑ Remote Management Using AMT

❑ Upgrading the BIOS

Entering the BIOS Setup

To enter the BIOS setup utility, press the **F2** key while the system is booting up. The main **BIOS Setup** screen will appear. You can configure the following settings on this screen.

- **Continue:** Continue to boot up
- **Boot Manager:** Select the device for booting up
- **Device Manager:** Enter the device configuration menu
- **Boot From File:** Select the UEFI boot-up file
- **Administer Secure Boot:** Enter the Secure Boot menu
- **Setup Utility:** Enter the BIOS configuration menu
- **Intel® Management Engine BIOS Extension:** Enter the AMT configuration menu

Select **F2** to enter the **BIOS configuration**.

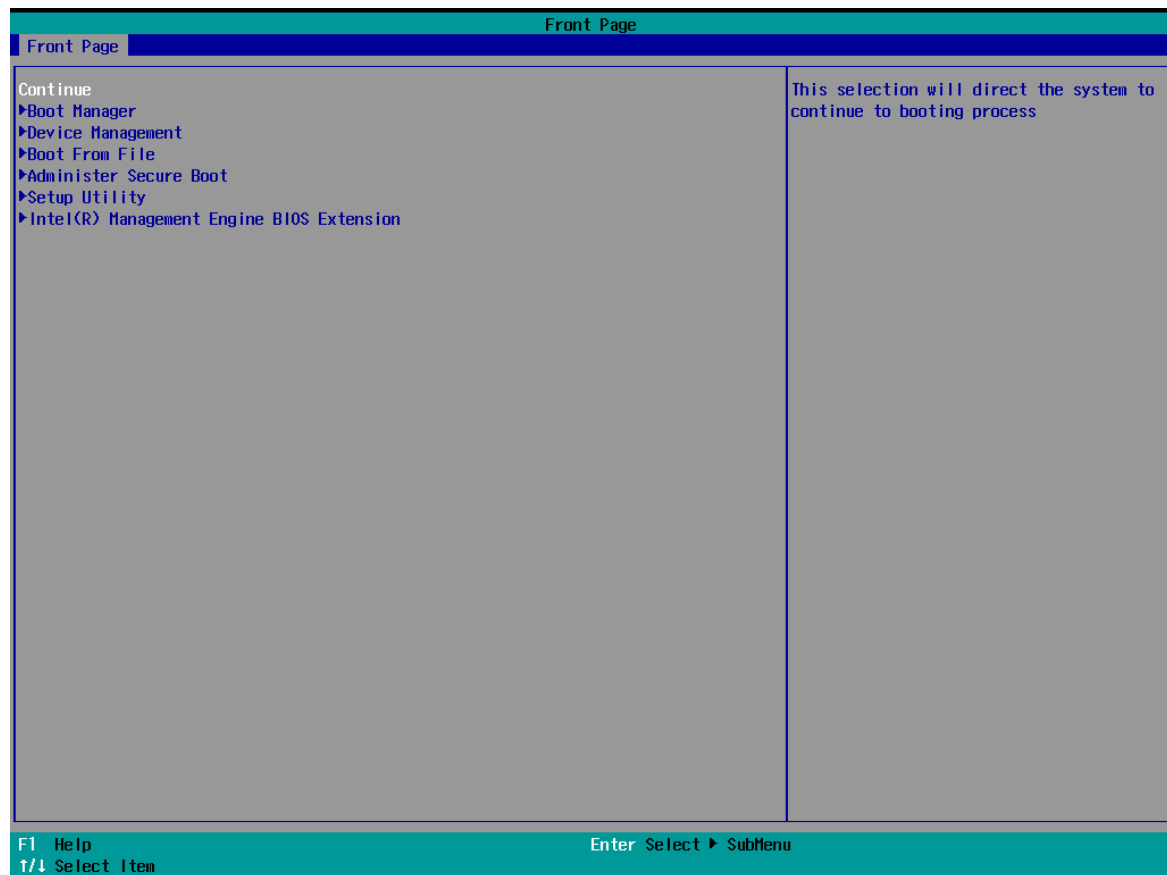

When you enter **Setup Utility**, a basic description of each function key is listed at the bottom of the screen. Refer to these descriptions to learn how to use them.

F1	General Help	↑ ↓ .	Select Item
F5/ F6	Change Values	← →	Select Menu
F9	Setup Defaults	ESC	Exit
F10	Save and Exit	ENTER	Select or go to Submenu.

NOTE The Secure Boot function is only available in models with 8th Gen processors. For details refer to the "Secure Boot Settings" section.

The BIOS configuration screen will be shown when you enter the **Setup Utility** option, as shown in the following figure:

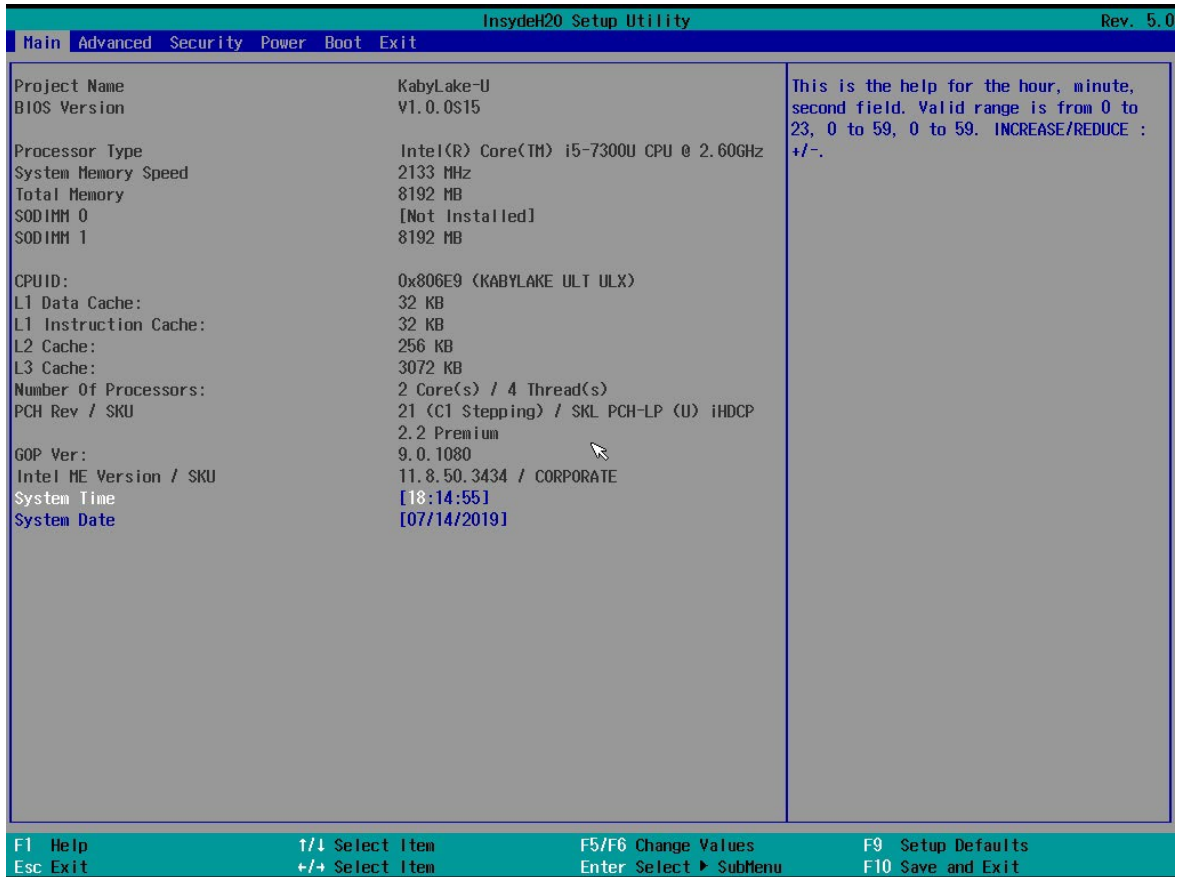

NOTE The **Processor Type** information will vary depending on the model that you have purchased.

Main Page

The **Main** page displays basic system hardware information, such as model name, BIOS version, and CPU type.

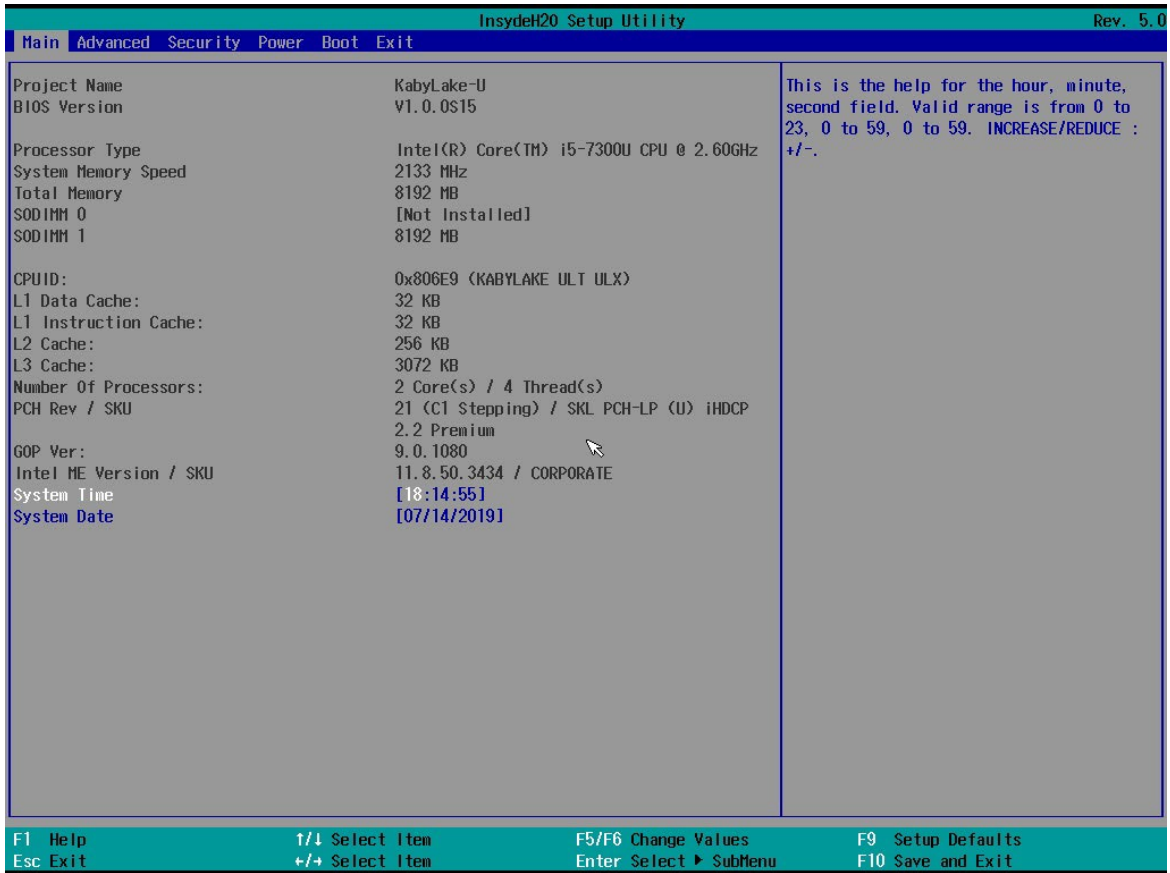

Advanced Settings

Select the **Advanced** tab in the main menu to open the advanced features screen.

NOTE The **Active Management Technology** is not supported in the KL1 and KL3 models.

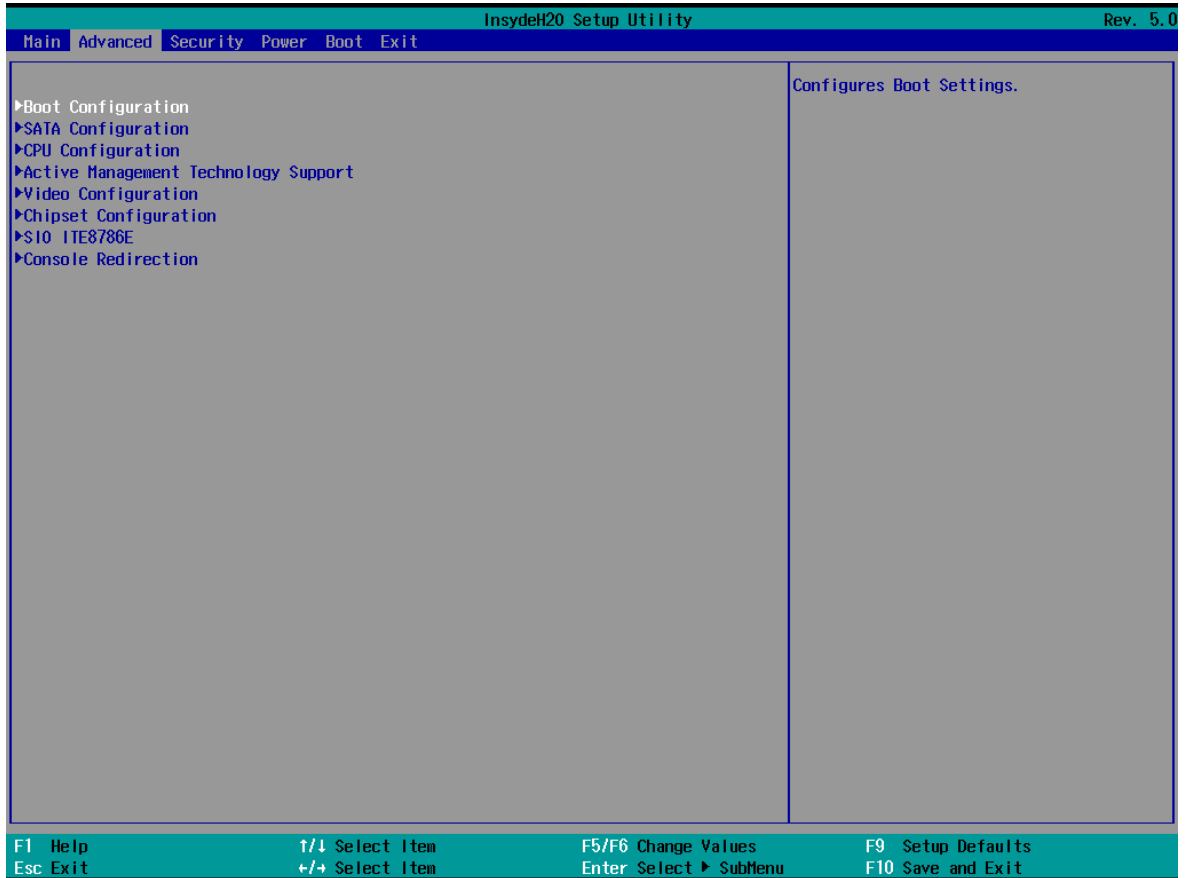

Boot Configuration

This item allows users to configure the default value of Numlock.

Options: On (default), Off.

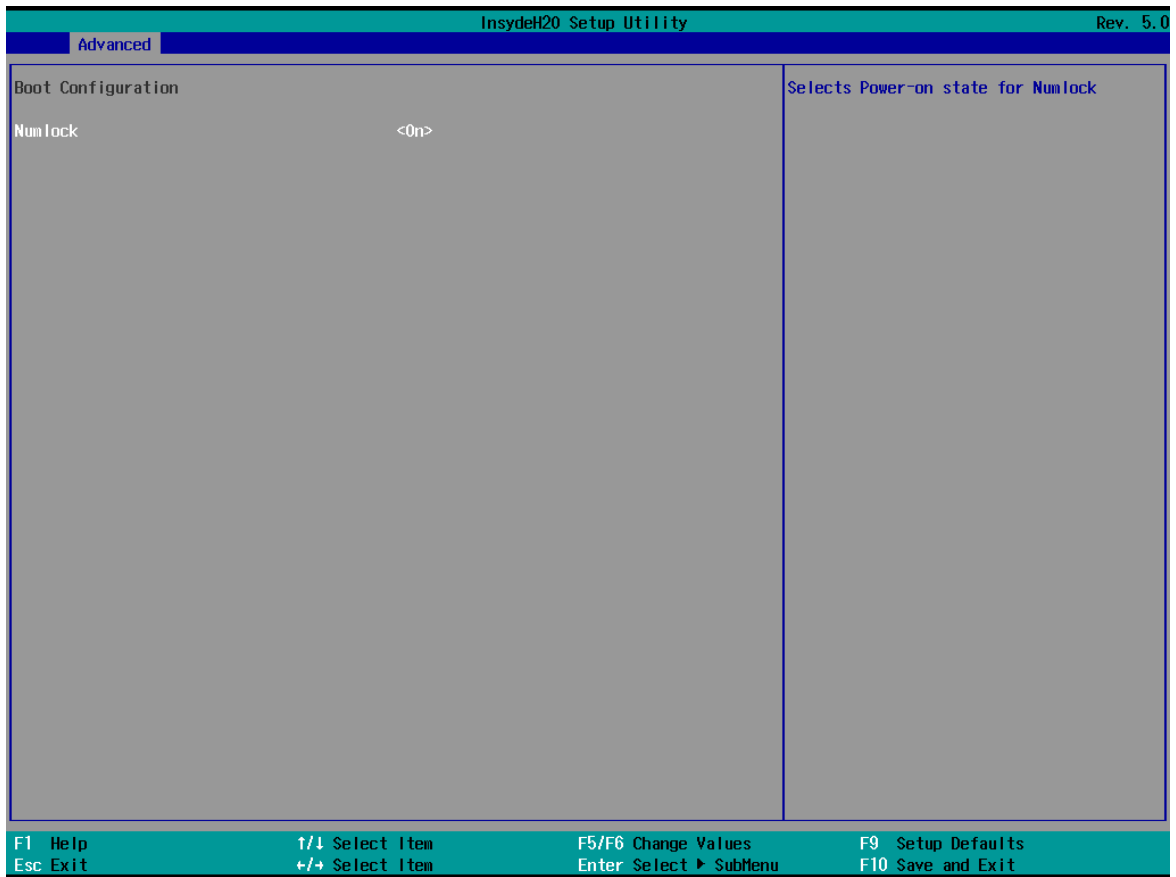

SATA Configuration

You can use this setting to select the mode for the host drive controller. Options are **AHCI** (default) and **Intel RST Premium**.

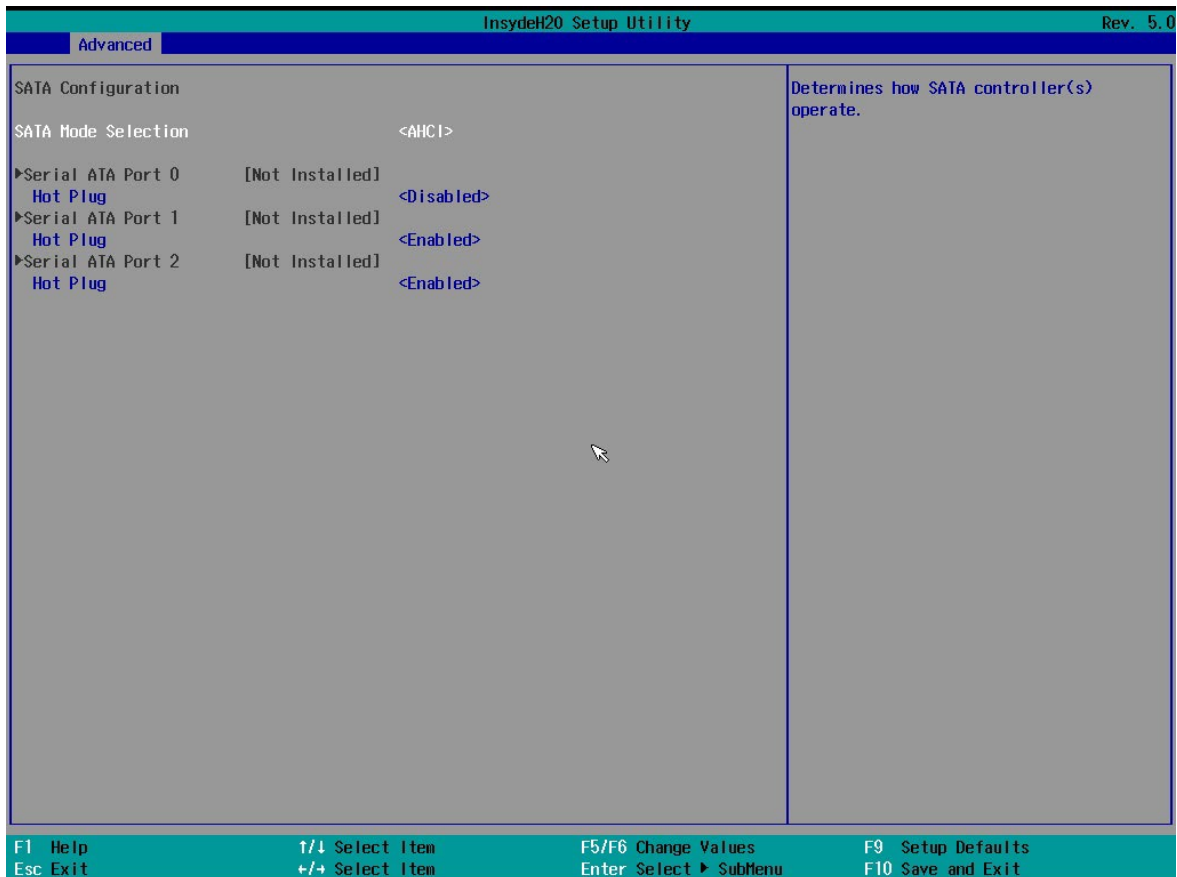

Serial ATA Port

This setting displays information on the installed drives.

SATA Port Hot Plug

This setting allows you to enable/disable hot-plugging capabilities (the ability to remove the drive while the computer is running) for installed storage drives.

Options: Disabled (default for Port 0), Enabled (default for Port 1 and Port 2)

RAID

Set HDC configuration as "Intel RST Premium" to enable **r**edundant **a**rray of **i**nexpensive **d**isks technology. The V2406C has three SATA interfaces, which only supports RAID levels 0, 1, 5 and Recovery.

Recovery utilizes RAID 1 (mirroring) functionality to copy data from a designated master drive to a designated recovery drive. The master drive data can be copied to the recovery drive either continuously or on request.

When using the continuous update policy, changes made to the data on the master drive while the system is not docked are automatically copied to the recovery drive when the system is re-docked. When using the on request update policy, the master drive data can be restored to a previous state by copying the data on the recovery drive back to the master drive.

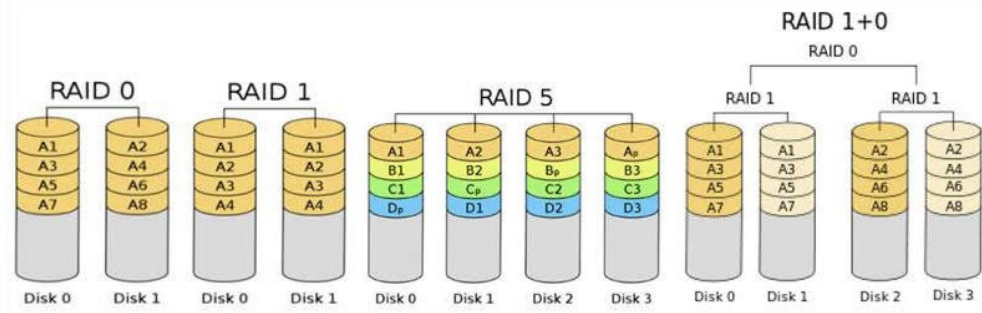

Source: http://en.wikipedia.org/wiki/Standard_RAID_levels for details.

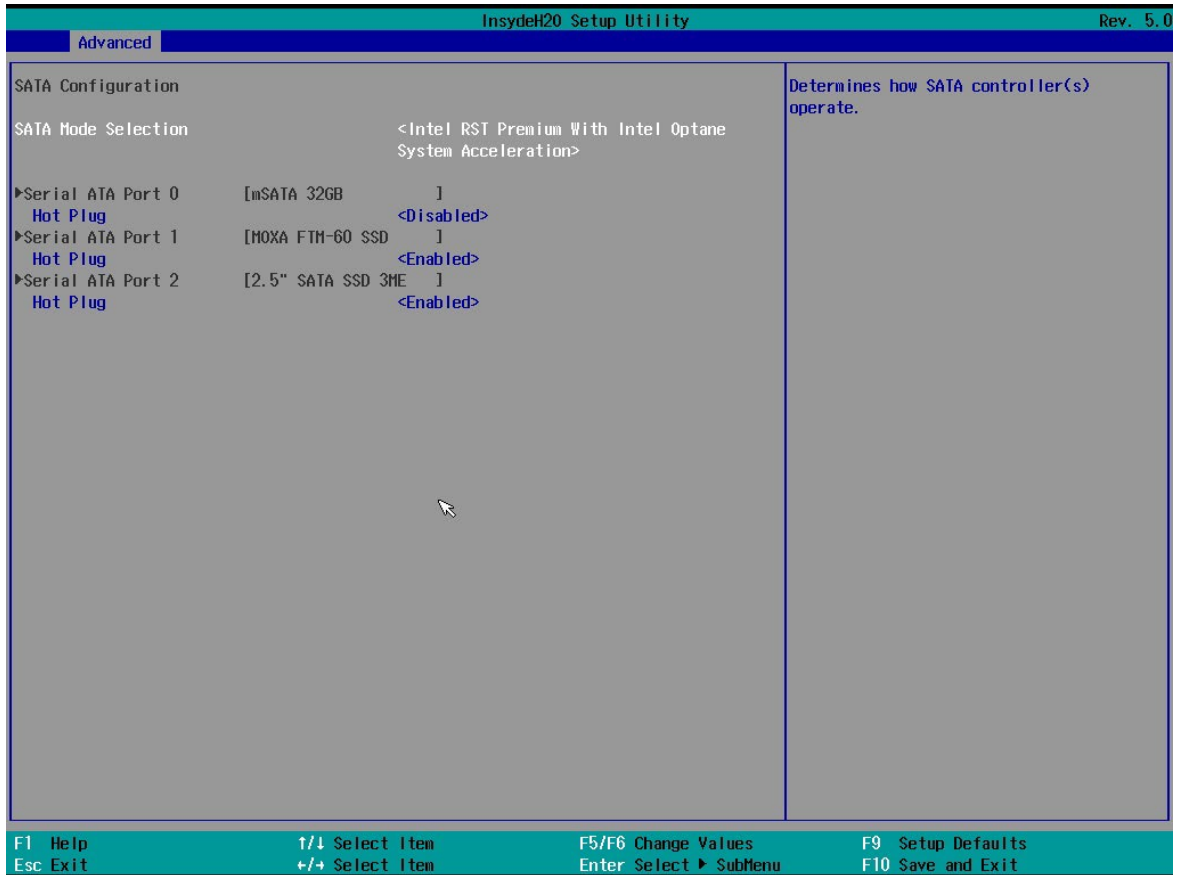

When setting the Intel RST Premium mode, or saving changes and reboot, you can select **Device Management** to configure the following Intel Rapid Storage Technology.

Intel Rapid Storage Technology

This section allows users to configure Intel® Rapid Storage Technology.

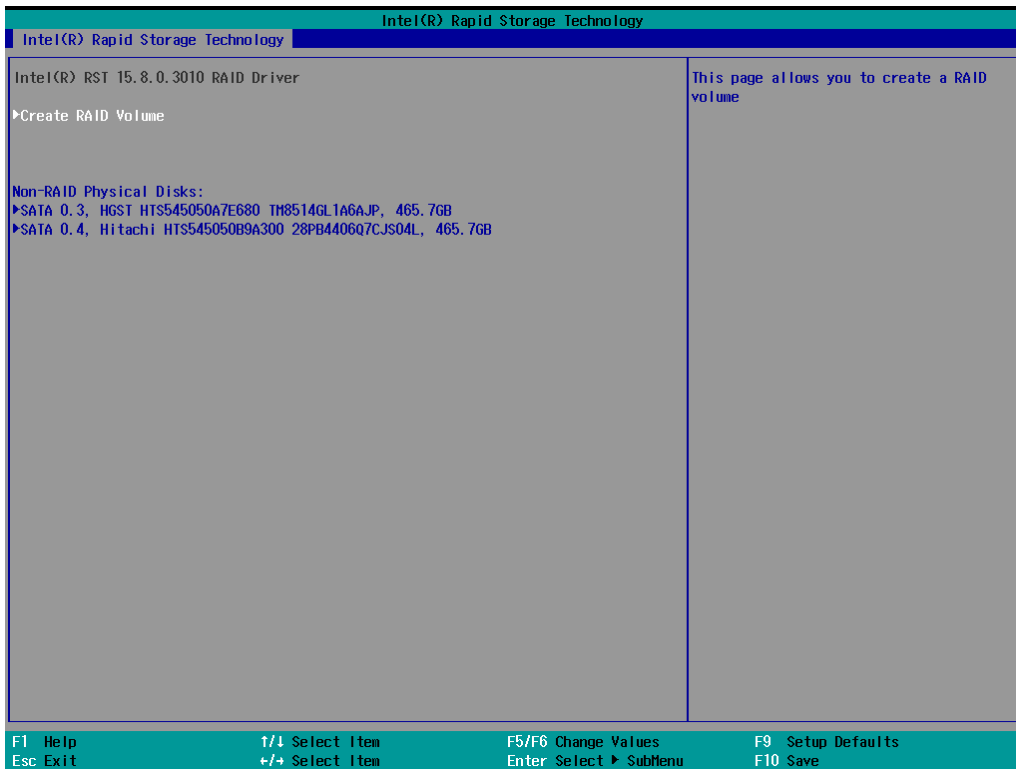

CPU Configuration

NOTE Hyper-Threading is not supported in the models with the Intel® Celeron® processor.

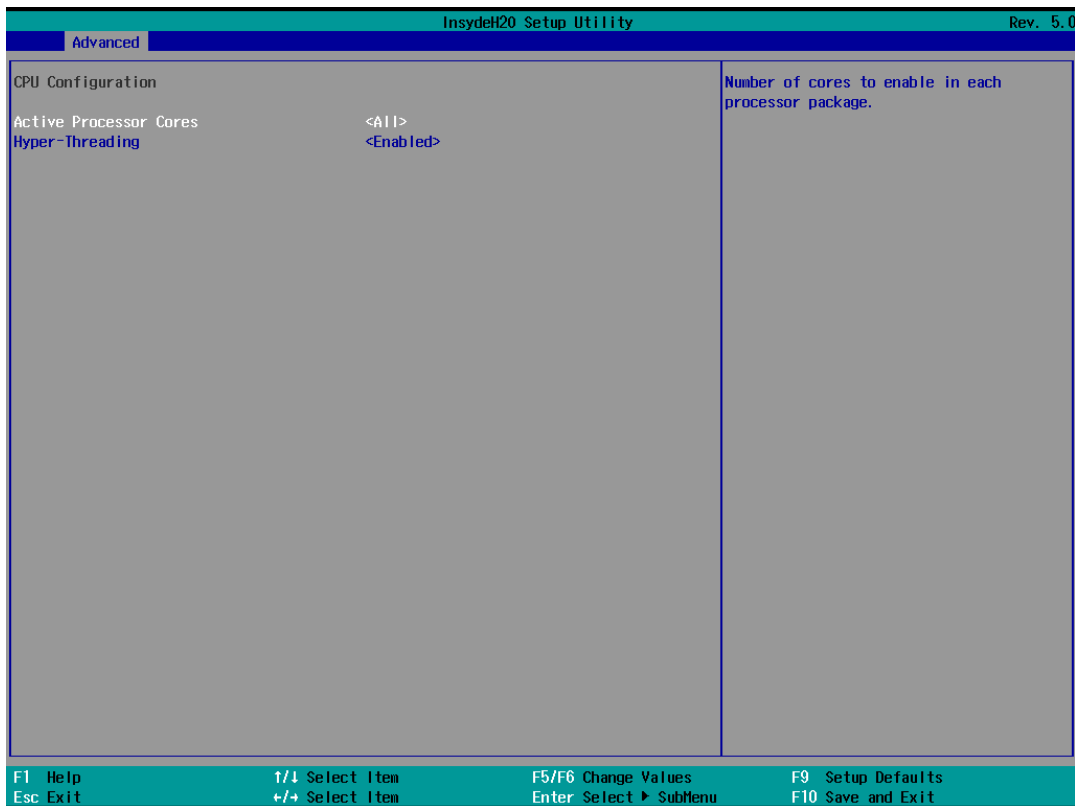

Active Processor Cores

This item indicates the number of cores to enable in each processor package.

Hyper-Threading

This feature makes the processor resources work more efficiently, enabling multiple threads to run on each core. It also increases processor throughput, improving overall performance on threaded software.

Options: Disabled, Enabled (default)

Active Management Technology Support

This item allows you to configure the Intel® Active Management Technology (Intel® Celeron® and i3 models do not support this function).

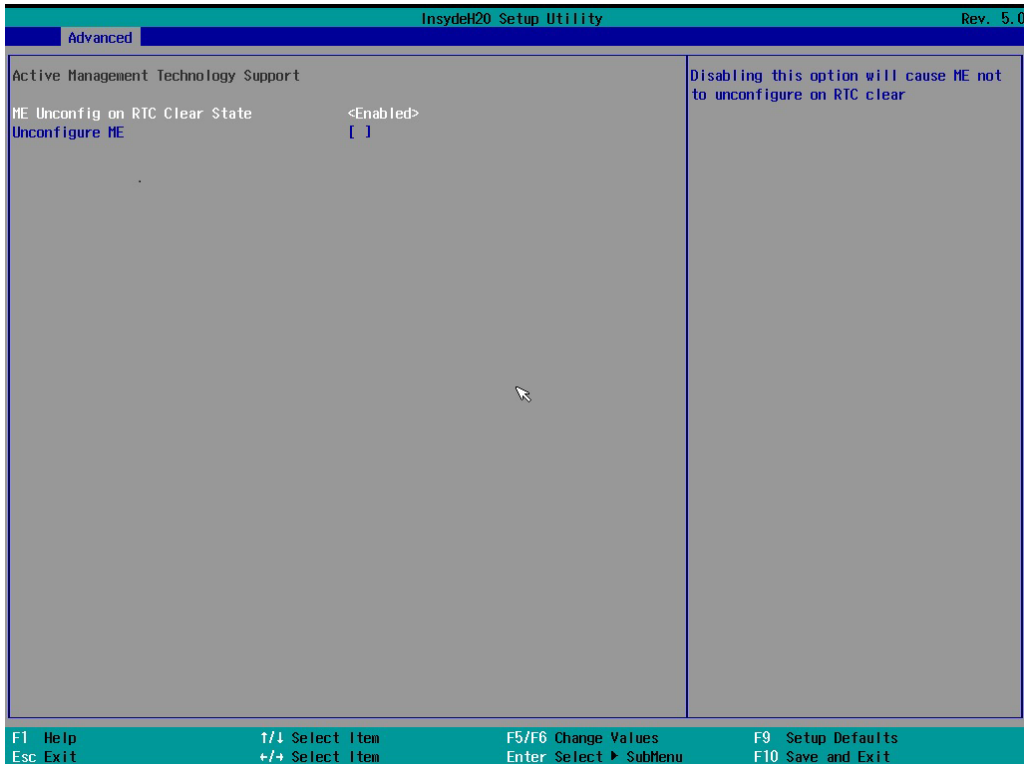

Unconfigure ME on RTC Clear State

Disabling this option will cause ME not to unconfigure on RTC clear.
Options: Disabled, Enabled (default)

Unconfigure ME

Unconfigure ME by resetting the MEBx password to the default password.

Video Configuration

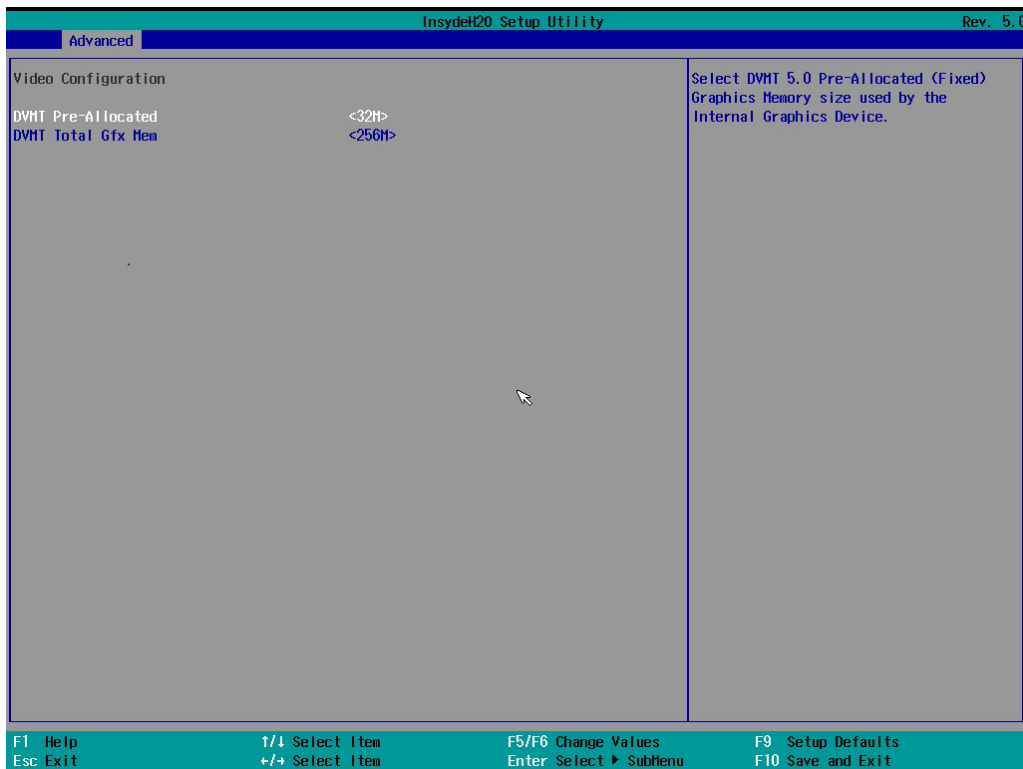

DVMT Pre-Allocated

This item allows you to configure pre-allocated memory capacity for the IGD. Pre-allocated graphics memory is invisible to the operating system.

Options: 12 M, 16M, 20M, 24M, 28M, 32M (default), 36M, 40M, 44M, 48M, 52M, 56M, 60M, 64M

DVMT: The amount of video memory your computer has is dependent on the amount of pre-allocated memory set for your system plus the Dynamic Video Memory Technology (DVMT). DVMT dynamically allocates system memory for use as video memory creating the most efficient use of available resources for maximum 2D/3D graphics performance.

DVMT Total Gfx Mem.

This item allows you to configure the maximum amount of memory DVMT will use when allocating additional memory for the internal graphics device.

Options: 256 MB (default), 128 MB, Max.

Chipset Configuration

This item allows you to configure the chipset settings.

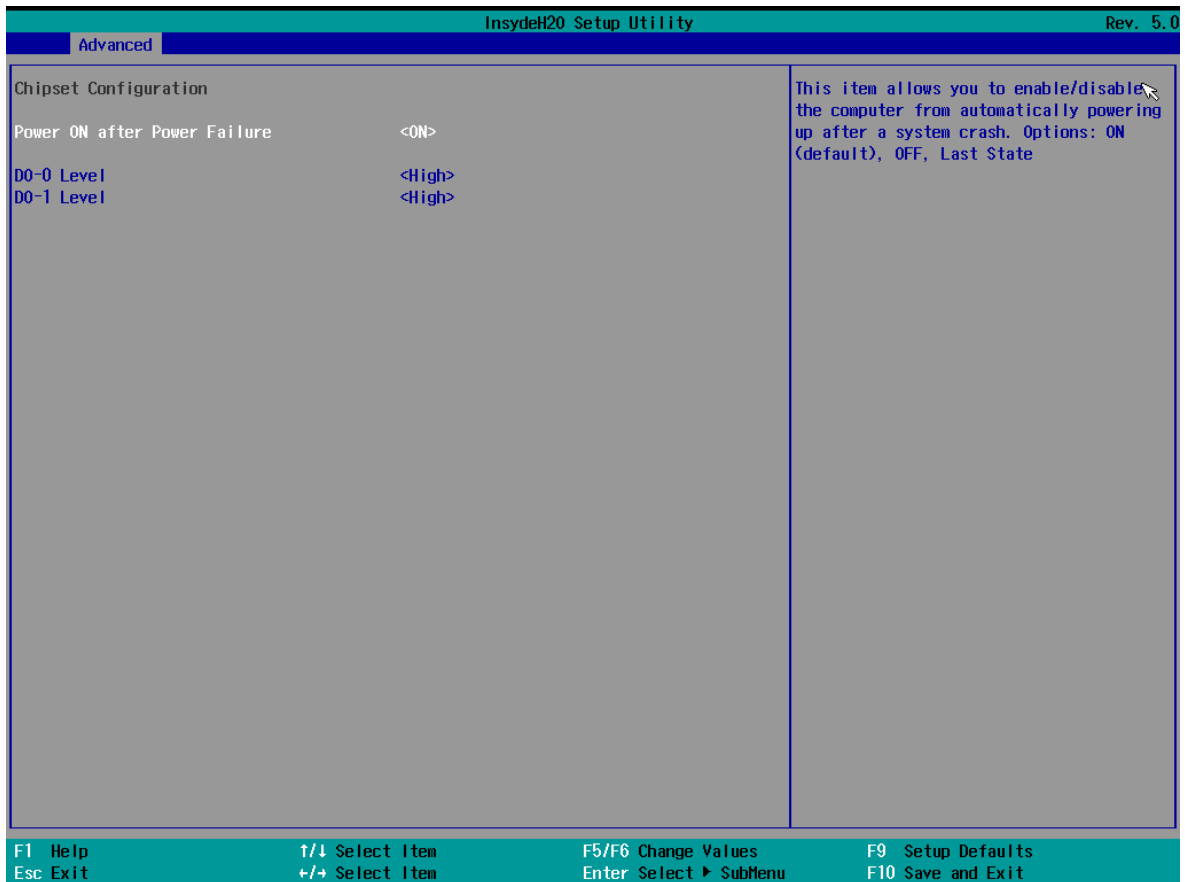

Power ON after Power Failure

This item allows you to enable/disable the computer from automatically powering up after system power is re-enabled.

Options: ON (default), OFF, Last State

DO-0 Level

This item allows users to set the DO 0 as high or low.

Options: High (default), Low

DO-1 Level

This item allows users to set the DO 1 as high or low.

Options: High (default), Low

SIO ITE8786E

This section allows users to configure serial port settings.

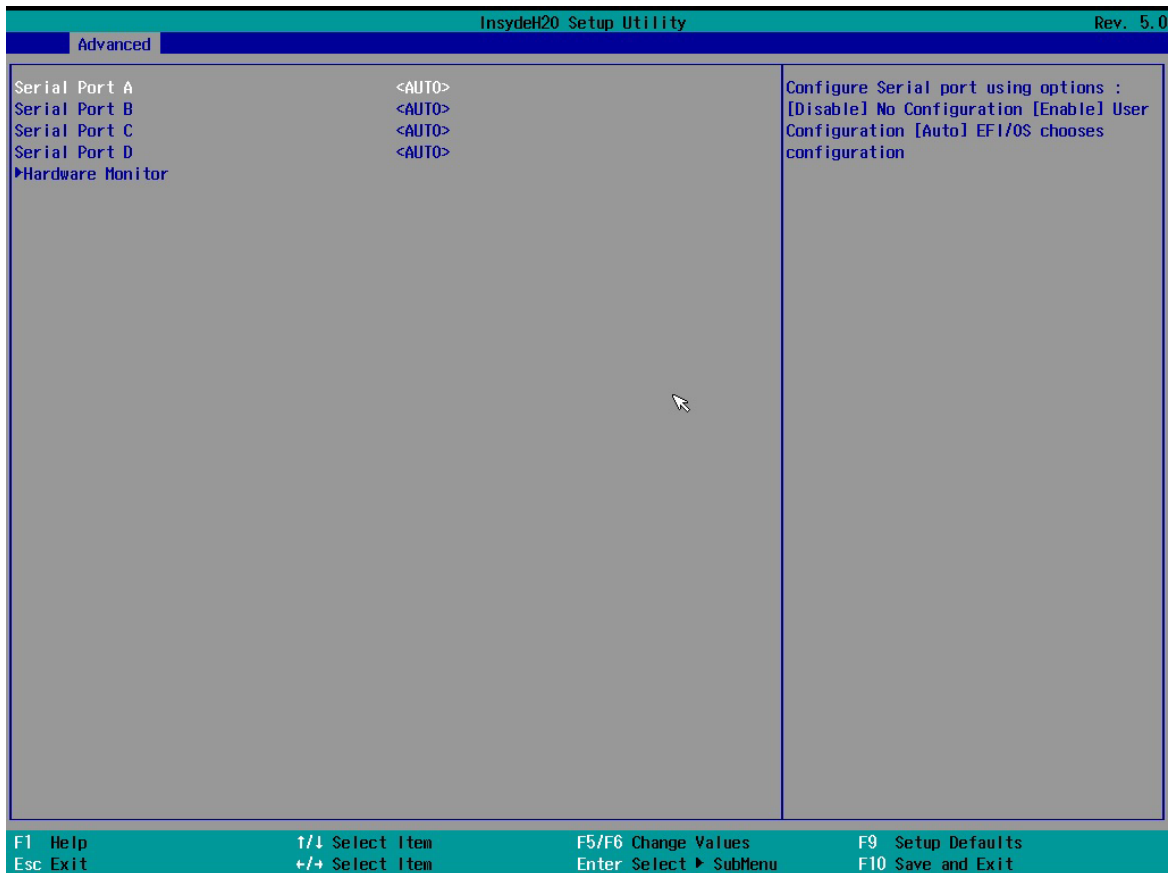

Serial Port A

This function allows users to configure the resources for the serial port A.

Disable: No resources

Enable: User configures the resources

Auto (default): EFI/OS chooses the resources

Serial Port B

This function allows users to configure the resources for the serial port B.

Disable: No resources

Enable: User configures the resources

Auto (default): EFI/OS chooses the resources

Serial Port C

This function allows users to configure the resources for the serial port A.

Disable: No resources

Enable: User configures the resources

Auto (default): EFI/OS chooses the resources

Serial Port D

This function allows users to configure the resources for the serial port A.

Disable: No resources

Enable: User configures the resources

Auto (default): EFI/OS chooses the resources

Hardware Monitor

This item allows you to view stats such as CPU and system temperature, voltage levels, and other chipset information.

The screenshot shows the 'Advanced' tab of the 'InsydeH20 Setup Utility' (Rev. 5.0). The 'Hardware Monitor' section displays the following data:

Voltage	
3.3V	3.288 V
5V	4.896 V

Temperature	
System (°C/°F)	47°C/116°F
System2 (°C/°F)	46°C/114°F
CPU (°C/°F)	69°C/156°F

At the bottom of the screen, a navigation bar contains the following key functions:

F1 Help	↑/↓ Select Item	F5/F6 Change Values	F9 Setup Defaults
Esc Exit	+/- Select Item	Enter Select ▸ Submenu	F10 Save and Exit

Console Redirection

When the Console Redirection Function is enabled, the console information will be output to both the HDMI monitor and through the serial port.

Options: Disabled (default), Enabled

Security Settings

This section allows users to configure security-related settings with a supervisor password and user password.

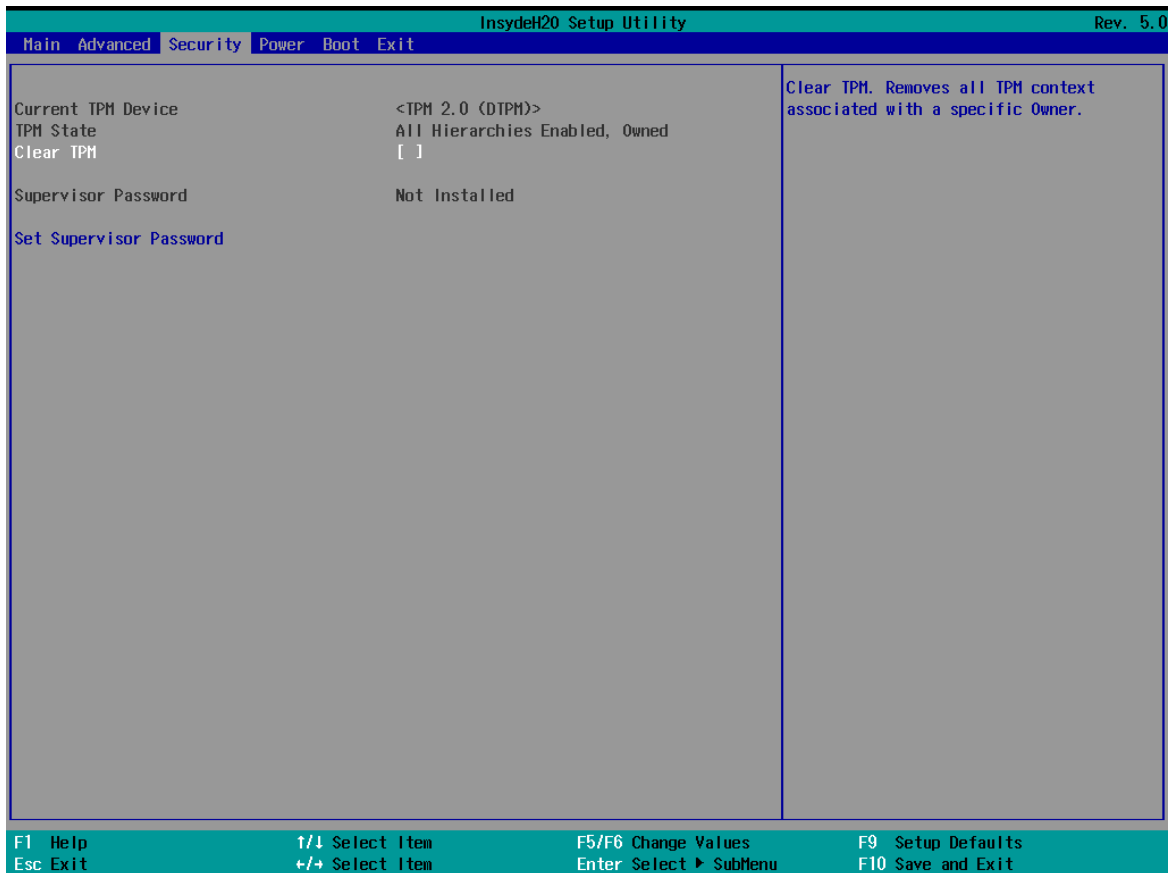

Current TPM Device

This item shows if the system has TPM device and its type.

TPM State

This item allows you view the status of current TPM settings.

Clear TPM

This item allows users to remove all TPM context associated with a specific owner.

Set Supervisor Password

This item allows you to set the supervisor password. Select the **Set Supervisor Password** option and enter the password and confirm the password again.

To delete the password, select the **Set Supervisor Password** option and enter the old password; leave the new password fields blank, and then press enter.

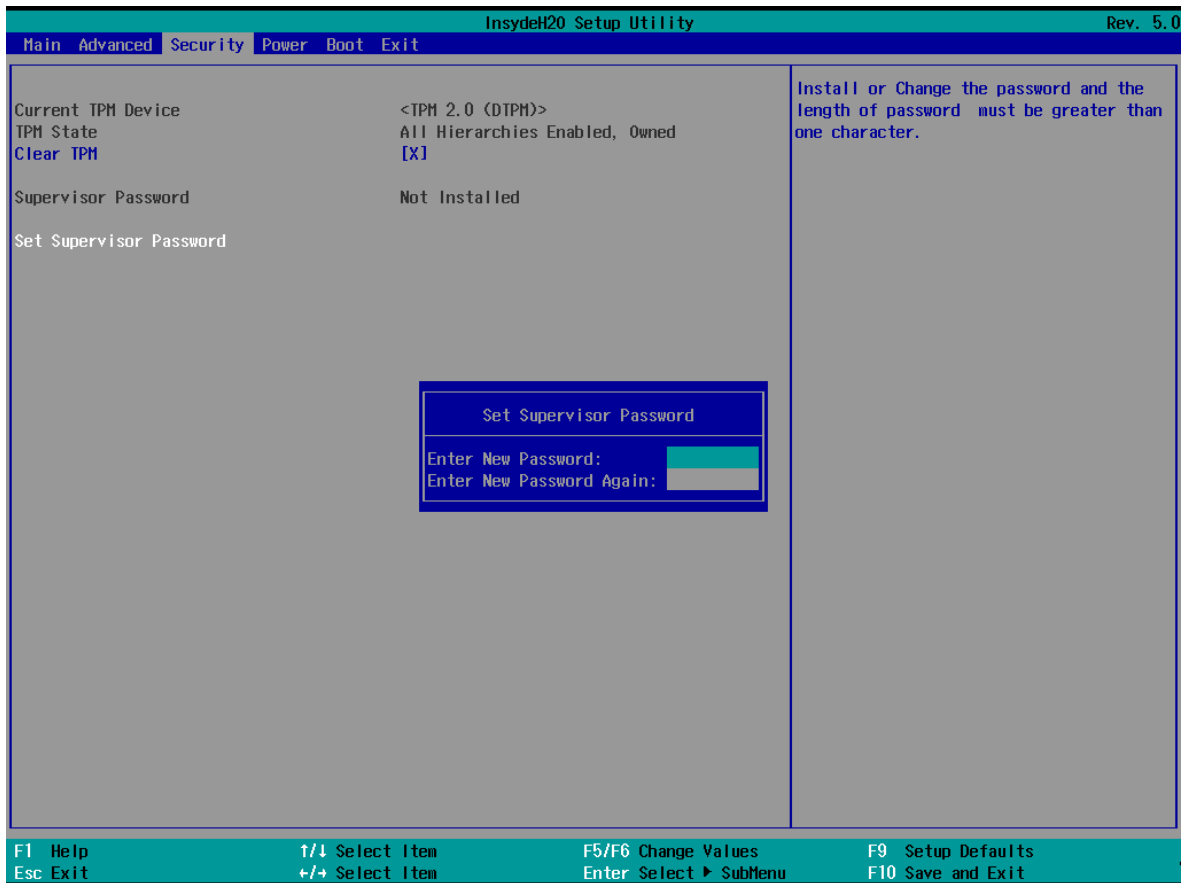

After the supervisor password is set, you can configure when the password screen should be displayed.

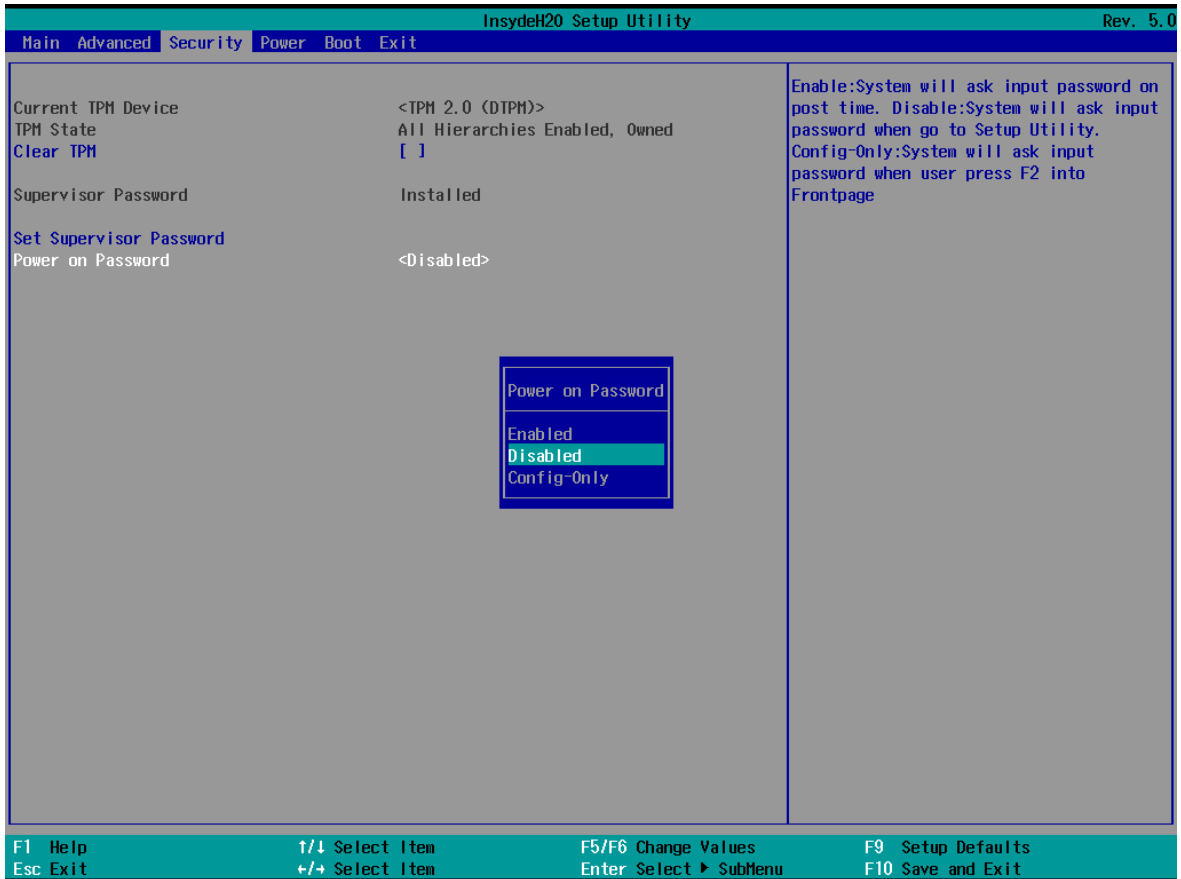

Enable: System will ask input password on post time.

Disable: System will ask for the password to go to the setup utility.

Config-Only: System will only ask for the password when you select the **config (F2)** option

Power Settings

The section allows users to configure power settings.

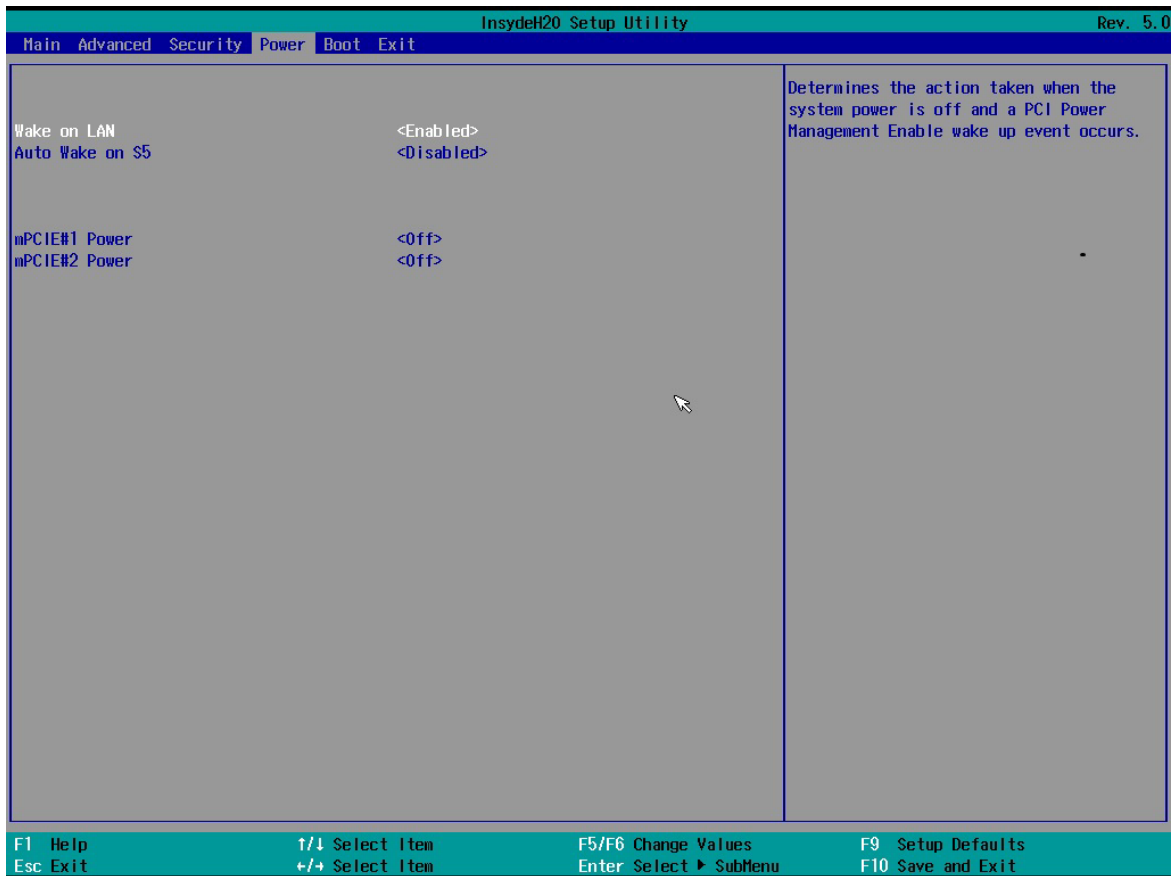

Wake on LAN

This feature is used to wake the system by a LAN device from a remote host.

Options: Enabled (default), Disabled

Auto Wake on S5

This item allows you to configure the computer to wake from S5 status. S5 stands for Soft Off, where the PSU remains engaged but power to all other parts of the system is cut. Auto-wake on S5 schedules a soft-reboot at certain periodic times that may be specified in the BIOS.

Options: Disabled (default); By Every Day (user specifies a regular daily time when the computer will power up); By Day of Month (user specifies a regular day each month when the computer will power up)

mPCIe#1 Power

This item allows you to control the power in the 1st mPCIe connector.

Options: Off (default), on

mPCIe#2 Power

This item allows you to control the power in the 2nd mPCIe connector.

Options: Off (default), on

Boot Settings

The section allows users to configure boot settings.

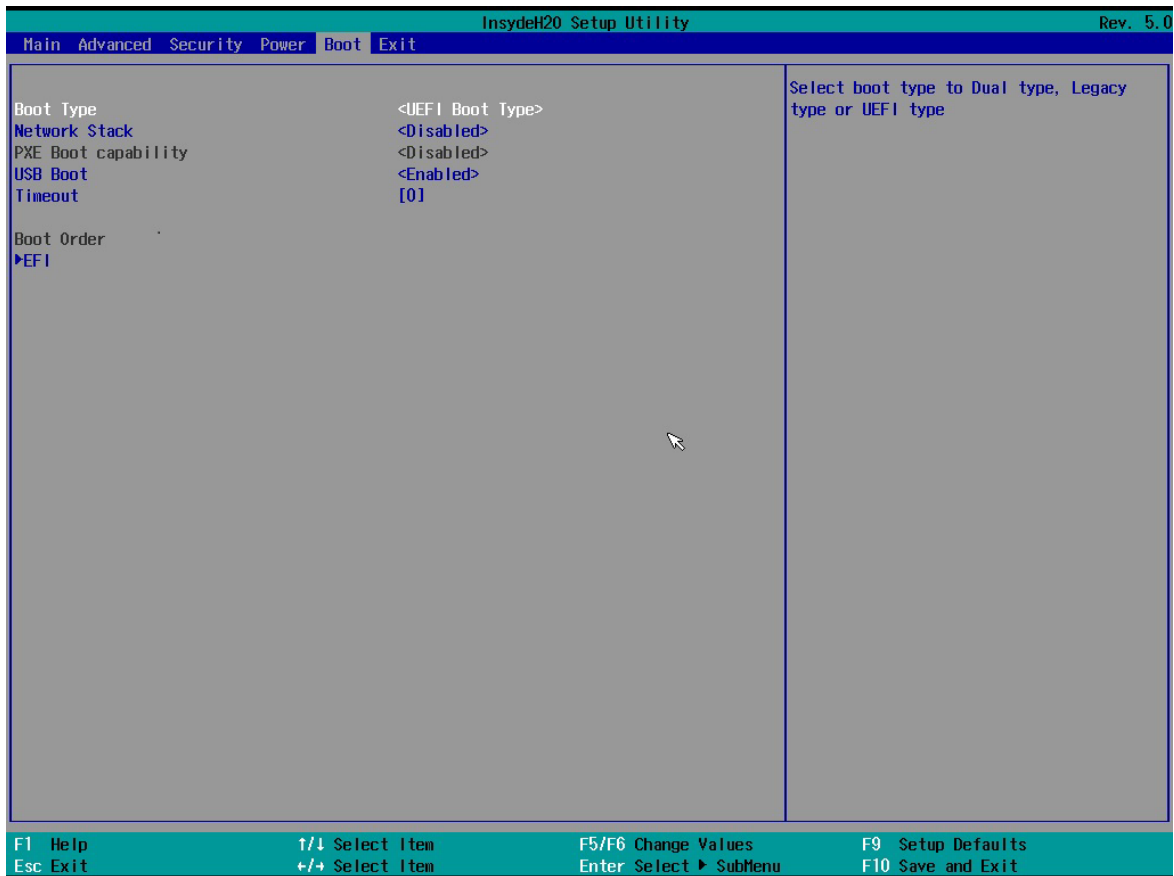

NOTE If you do not add any storage, you will not see the EFI option.

Boot Type

This item allows you to enable/disable the quick boot function.

Options: Dual Boot Type, Legacy Boot Type, UEFI Boot Type (default)

Network Stack

It deploys an Internet Protocol (IP) stack. The IP stack provides an application library to open/close connections to remote devices and send/receive data between the remote devices.

Options: Disabled (default), Enabled

PXE Boot capability

PXE Booting is booting a system over a network. This item allows users to start PXE over IPv4 or IPv6

Options: Disabled (default), UEFI: IPv4, UEFI: IPv6, UEFI: IPv4/IPv6

USB Boot

Set booting to USB boot devices capability.

Options: Enabled (Default), Disabled

Timeout

This item allows users to set the number of second that the firmware will wait before booting the original default boot selection.

EFI

This item allows users to select the boot order. Use F5 (move down) or F6 (move up) to change the value.

Secure Boot Settings

To Configure the Secure Boot setting, do the following:

1. Select the **Administer Secure Boot** option on the **Front Page**.

NOTE The Secure Boot function is only available in models with 8th Gen processors.

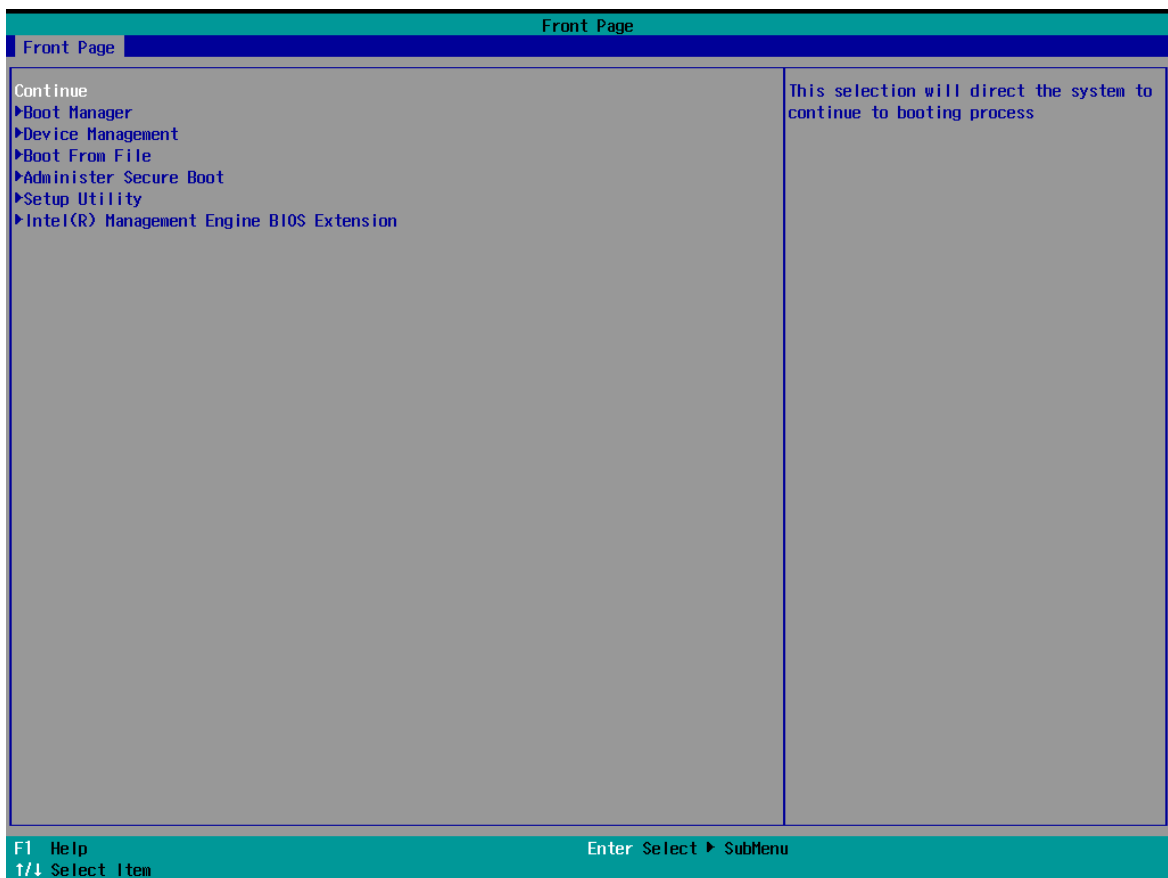

2. Select the option **Select a UEFI file as trusted for execution.**

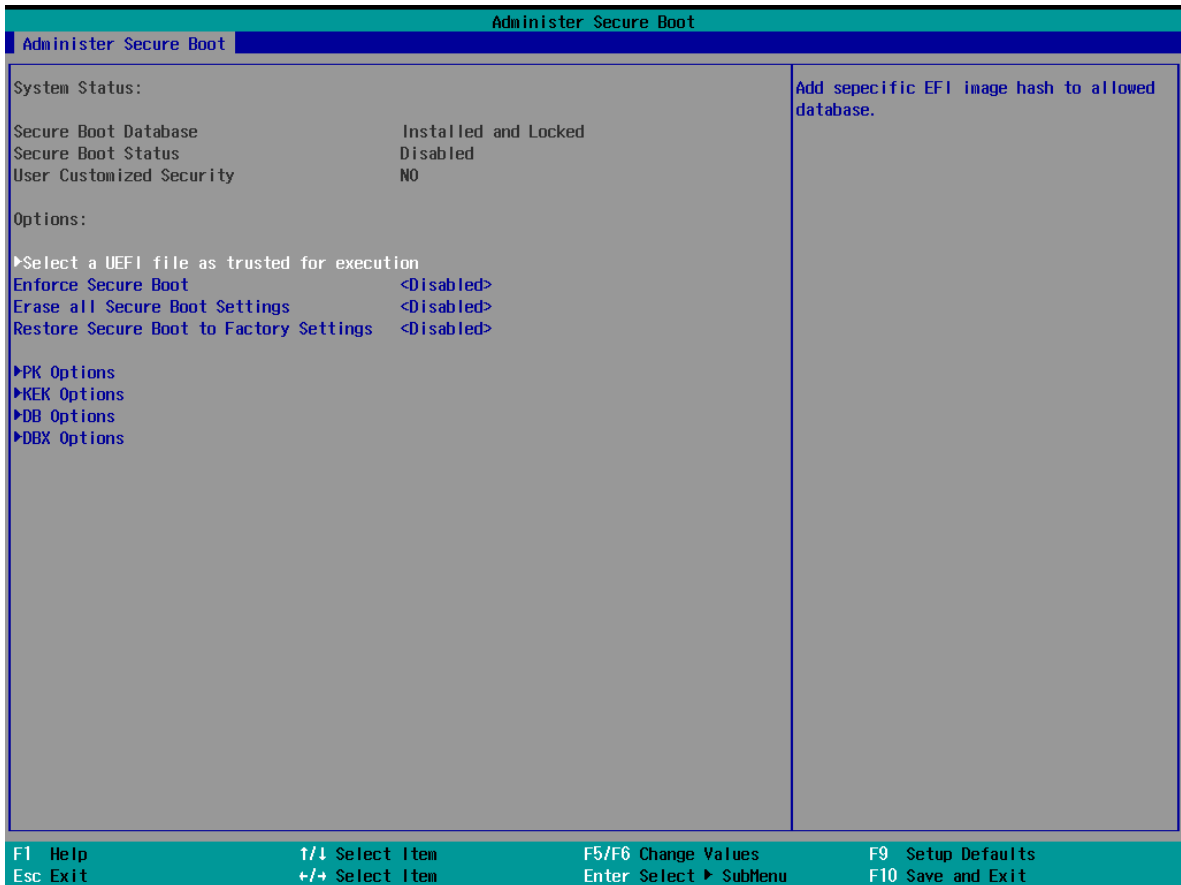

The system will select a source (from a USB, hard disk, or any storage device) for the UEFI file.

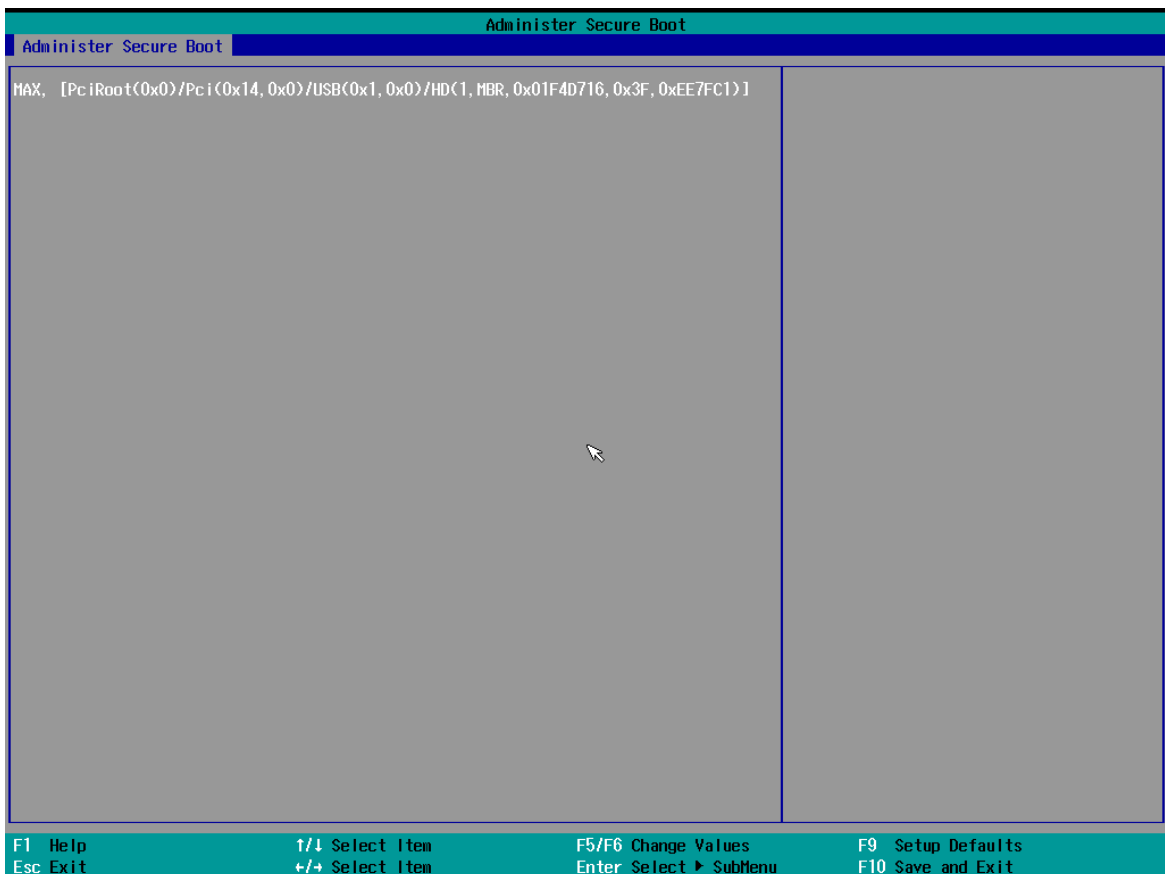

Enforce Secure Boot

This item allows you to disable or enable to enforce secure boot settings.

Options: Disabled (default), Enabled

Erase All Secure Boot Settings

This item allows you to disable or enable to erase all secure boot settings.

Options: Disabled (default), Enabled

Restore Secure Boot to Factory Settings

This item allows you to disable or enable to restore secure boot settings to the factory default status.

Options: Disabled (default), Enabled

Enabling AMT

NOTE The AMT function is not supported in KL1 and KL3 models.

To enter the BIOS setup utility, press the "F2" key while the system is booting up. The main **BIOS Setup** screen will appear. Five options will be available:

1. Select **Intel® Management Engine BIOS Extension** to enter the **AMT configuration**.

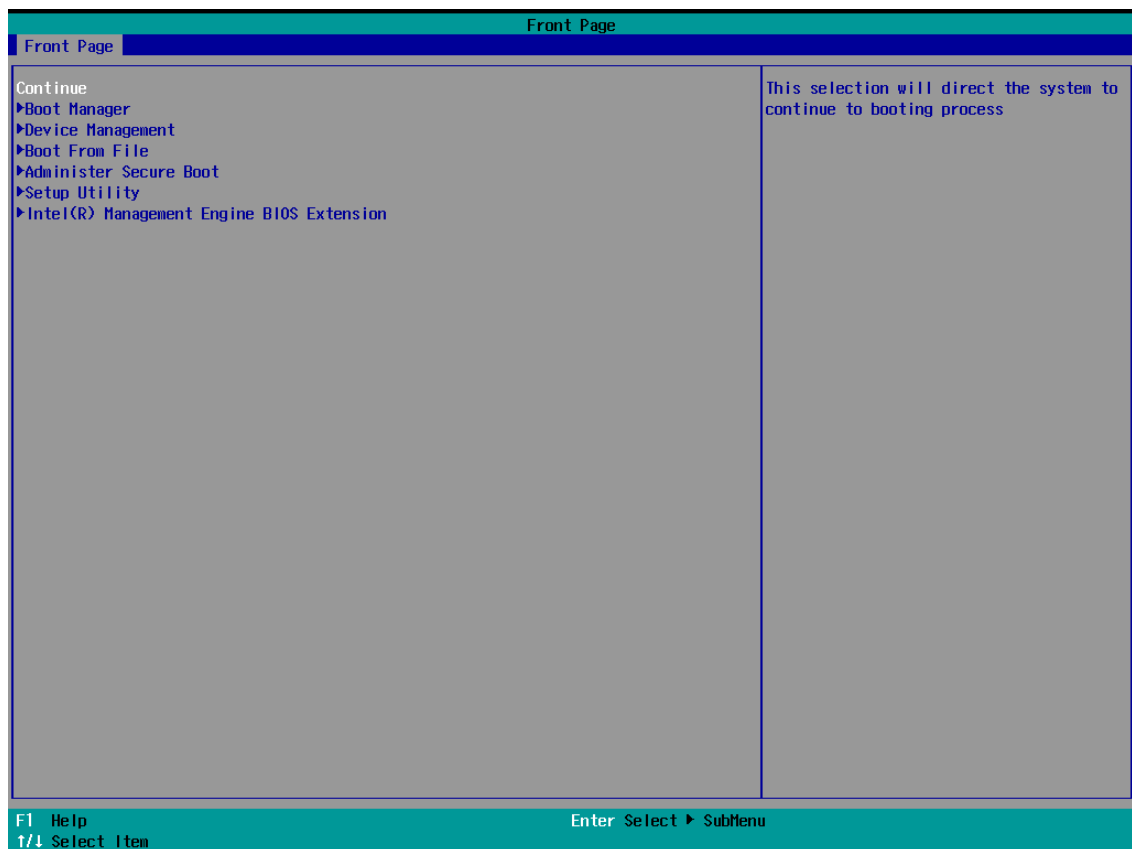

- 2. Press **<Enter>** to start the login procedure.

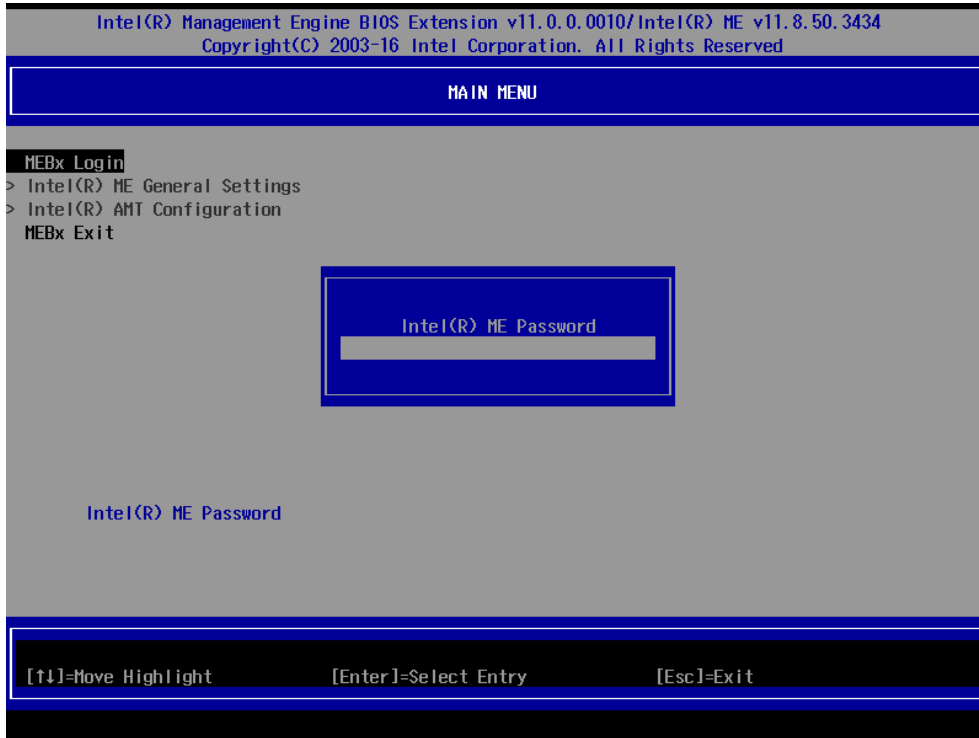

- 3. Type the default password: **admin**

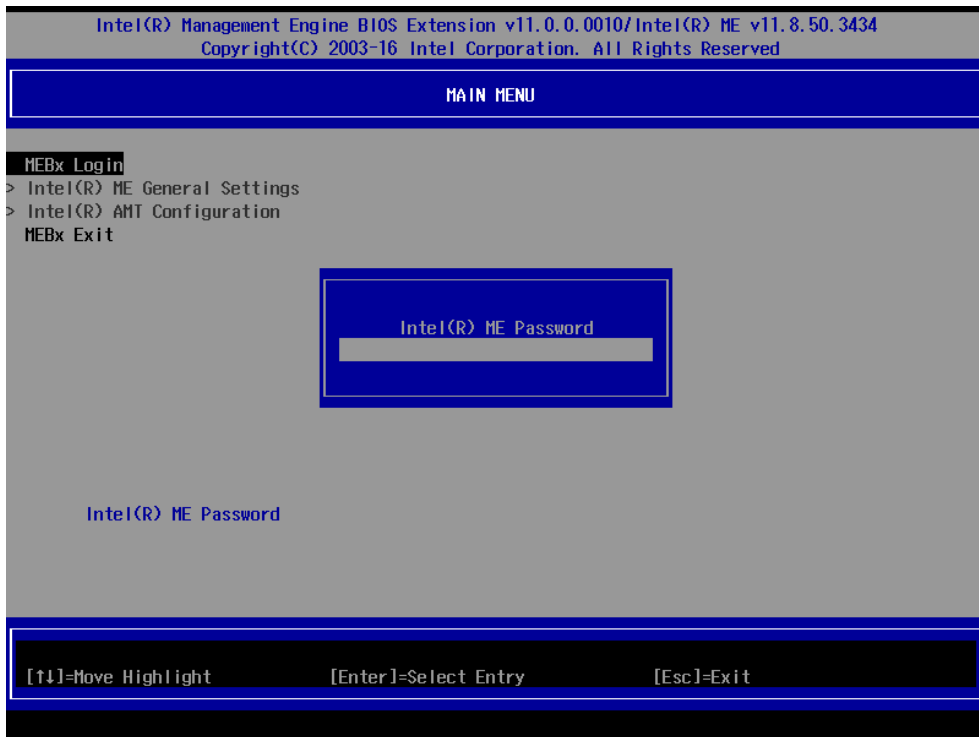

4. Type the new password. It must include both upper-case and lower-case characters, numbers, and special symbols. E.g., **Admin'12**.

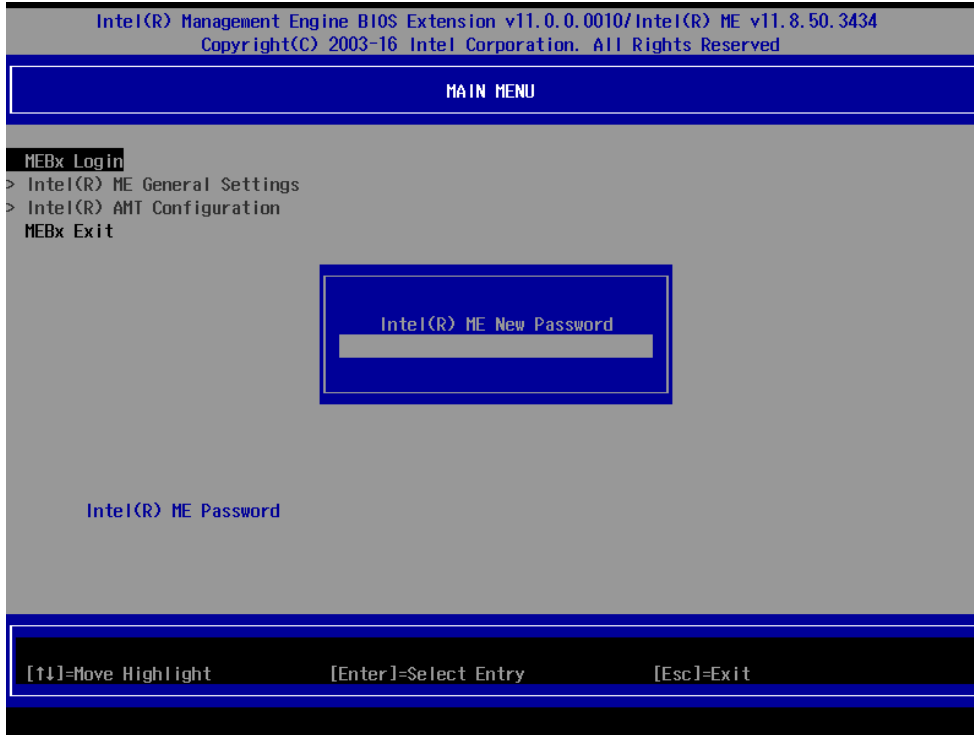

5. Select **Intel® AMT Configuration** to enable remote access without a local user present for consent, select **User Consent**, and then select **User Opt-in** and change the value to **None**.
6. Set static IP or DHCP by request.



7. Set **Activate Network Access** to enable remote access capability.

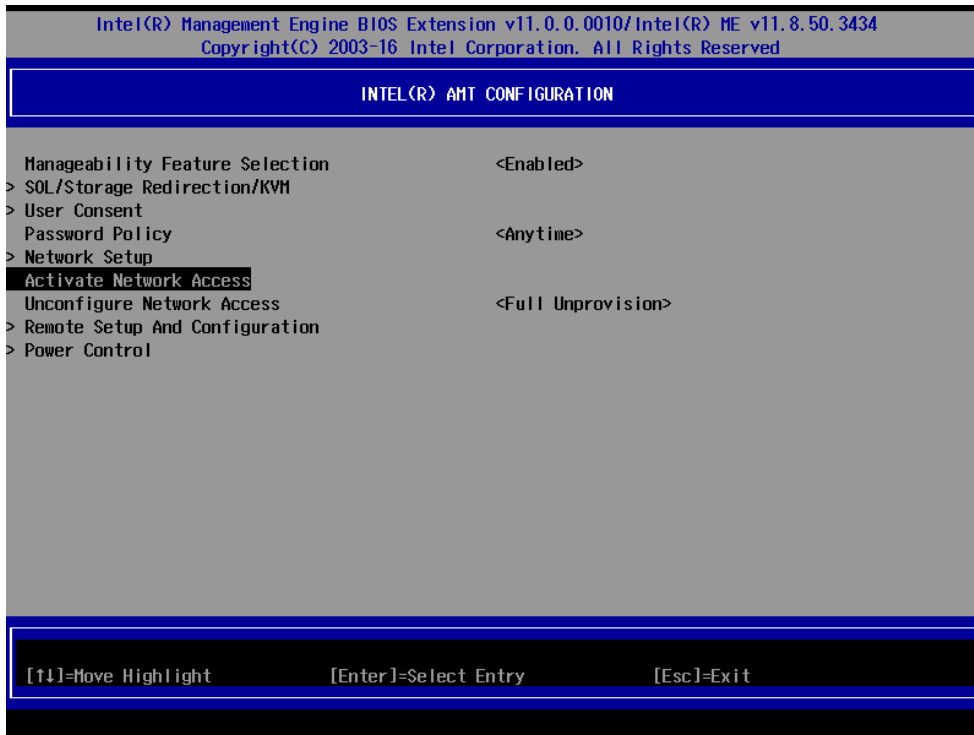

Exit Settings

The section allows users to exit the BIOS environment.

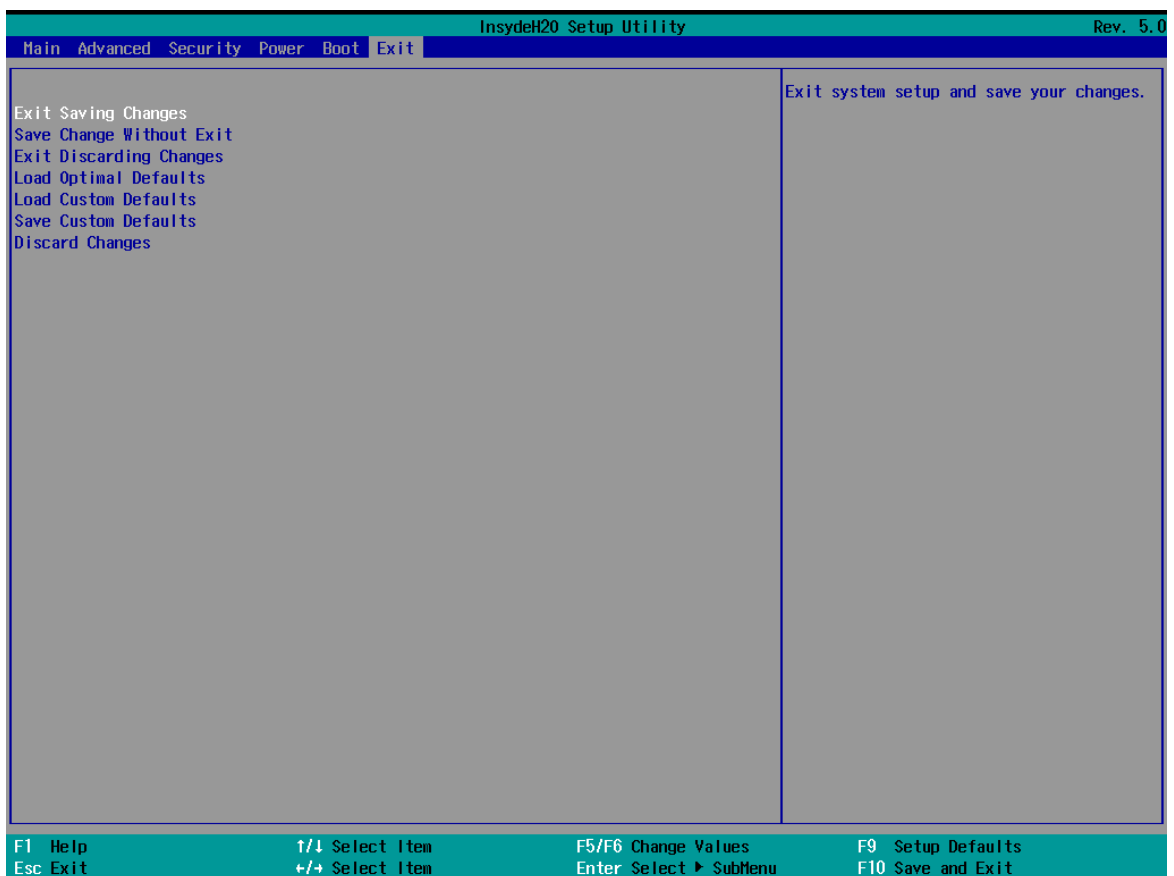

Exit Saving Changes

This item allows you to exit the BIOS environment and save the values you have just configured.

Options: Yes (default), No

Save Change Without Exit

This item allows you to save changes without exiting the BIOS environment.

Options: Yes (default), No

Exit Discarding Changes

This item allows you to exit without saving any changes that might have been made to the BIOS.

Options: Yes (default), No

Load Optimal Defaults

This item allows you to revert to the factory default BIOS values.

Options: Yes (default), No

Load Custom Defaults

This item allows you to load custom default values for the BIOS settings.

Options: Yes (default), No

Save Custom Defaults

This item allows you to save the current BIOS values as a "custom default" that may be reverted to at any time by the "load custom defaults" selection just above.

Options: Yes (default), No

Discard Changes

This item allows you to discard all settings you have just configured.

Options: Yes (default), No

Remote Management Using AMT

You can use any of the available AMT tools to execute the remote management function. The easiest method is using a web browser.

1. Type the IP for your V2406C that was configured in the AMT configuration with port **16992**. The AMT logon screen will appear.



2. Click on "Log On" and type the username (**admin**) and password to log in and control the V2406C remotely.

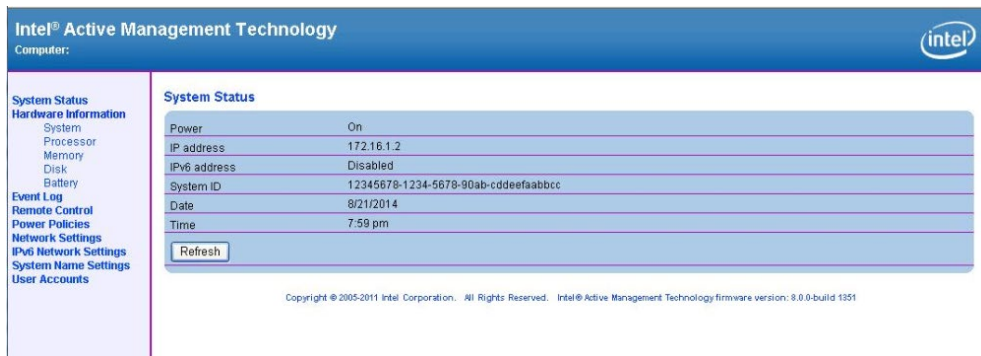

NOTE The V2406C's AMT port is LAN1.

NOTE Refer to the Intel AMT Implementation and Reference Guide for details:

https://software.intel.com/sites/manageability/AMT_Implementation_and_Reference_Guide/default.htm?turl=WordDocuments%2Faccessingintelamtviathewebuiinterface.htm

Upgrading the BIOS

This section describes how to upgrade the BIOS. However, note that it is easy to permanently damage the computer when upgrading the BIOS. We strongly recommend that you contact Moxa's technical support staff for assistance in order to obtain all the necessary tools and the most current advice before attempting to upgrade the BIOS on any Moxa device.

Step 1: Create a Bootable USB Disk

Before upgrading the BIOS, every user should first create a bootable USB drive as a system boot device.

1. Search "format", then select **Create and format hard disk partitions**.

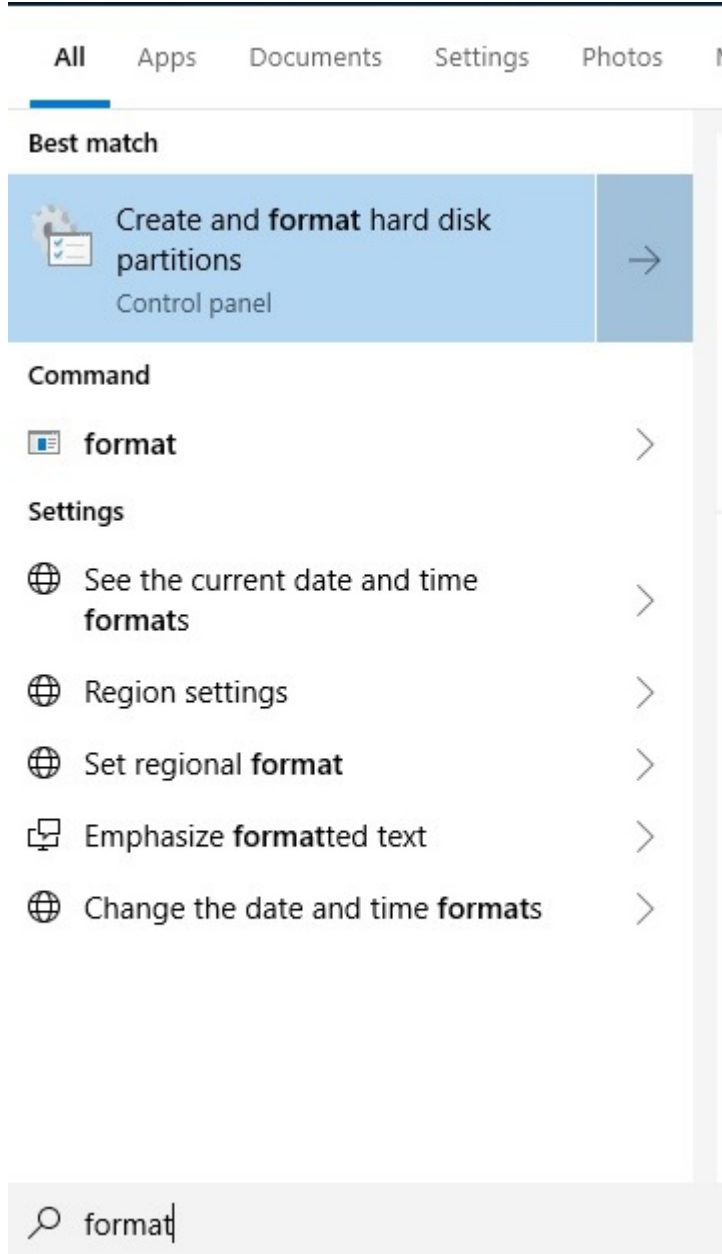

- Right click on the USB disk then select "Format".

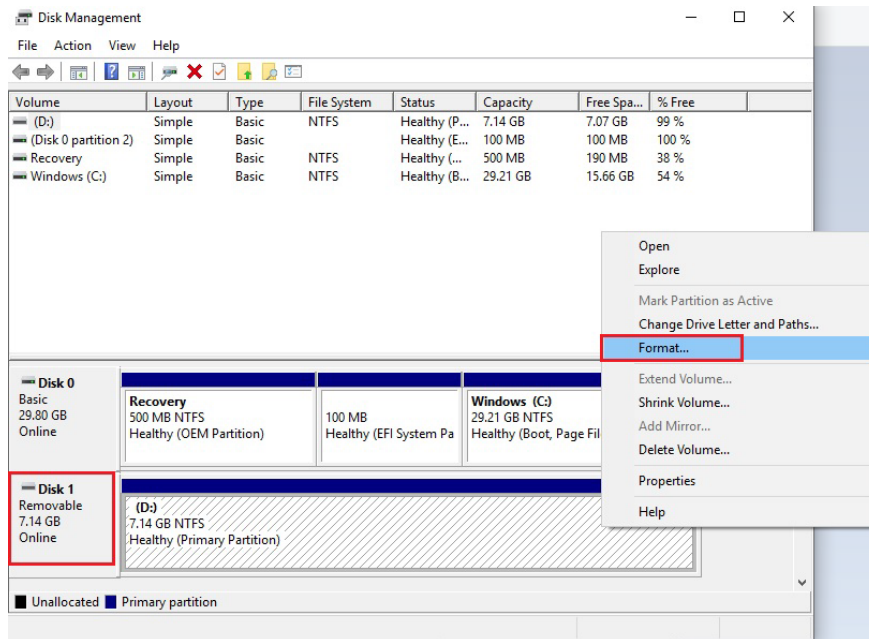

- Select "FAT32", and click OK to start formatting.

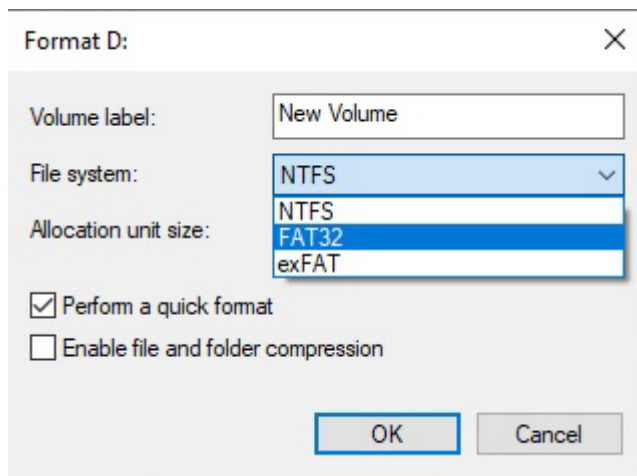

Step 2: Prepare the Upgrade File

You must use the BIOS upgrade installation file to upgrade the BIOS. Contact Moxa's technical department for assistance.

- Get the BIOS upgrade file; it includes an **efi** folder and a file **xxxx.efi**.
- Copy **efi** folder and **xxxx.efi** file to the Bootable USB Disk.

Step 3: Run the upgrade program on the Computer

1. Reboot the computer, and press F2 while booting up to go to the Boot Manager. If BIOS cannot recognize the USB drive as the boot devices, the USB drive could have no partition table. Use windows command line tool **diskpart** to rebuild the partition table.
2. Select the USB Disk



3. Screen will switch to the SHELL environment, type **fs0:** then, go to the directory where the upgrade file is located, and type **xxxxxx.efi** (the name is based on the upgrade file you get from Moxa).

```
Device mapping table
fs0      :Removable HardDisk - Alias hd24s0b blk0
         PciRoot(0x0)/Pci(0x14,0x0)/USB(0x12,0x0)/HD(1,MBR,0x00DD3D80,0x3F,0xEB5FC1)
blk0     :Removable HardDisk - Alias hd24s0b fs0
         PciRoot(0x0)/Pci(0x14,0x0)/USB(0x12,0x0)/HD(1,MBR,0x00DD3D80,0x3F,0xEB5FC1)
blk1     :Removable BlockDevice - Alias (null)
         PciRoot(0x0)/Pci(0x14,0x0)/USB(0x12,0x0)
hd24s0b  :Removable HardDisk - Alias fs0 blk0
         PciRoot(0x0)/Pci(0x14,0x0)/USB(0x12,0x0)/HD(1,MBR,0x00DD3D80,0x3F,0xEB5FC1)

Shell> fs0:

fs0:\> xxxxxxx.efi
```

4. The upgrade program will run automatically. Wait patiently until the procedure is finished.

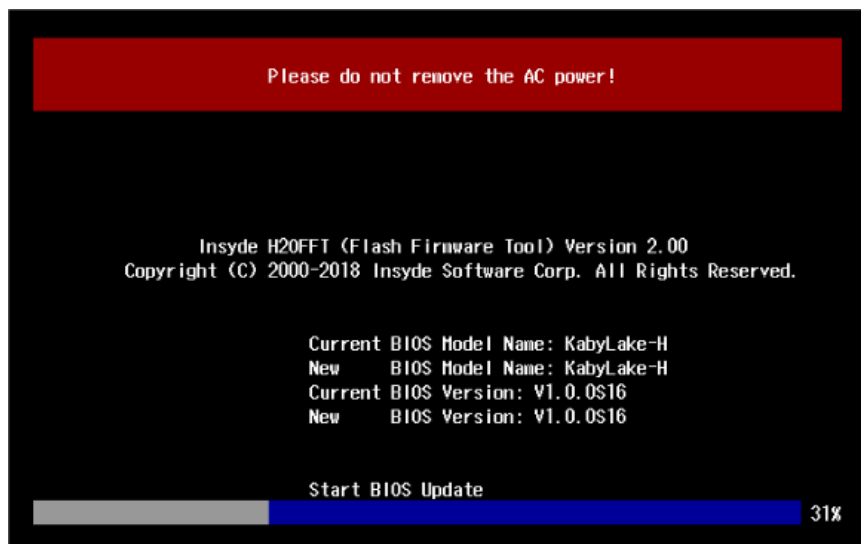

5. When the upgrade is finished, the computer will automatically reboot. You may check BIOS version on the Main page

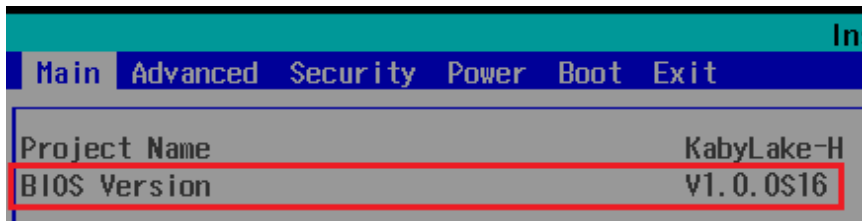

6. If the system has more than one boot device, you will see more than one fsx (x represents the number).

```
EFI Shell version 2.50 [22281.4149]
Current running mode 1.1.2
Device mapping table
fs0 :HardDisk - Alias hd33e0a2 blk0
      PciRoot(0x0)/Pci(0x17,0x0)/Sata(0x4,0x0,0x0)/HD(2,GPT,0AC3B829-99B0-4FDE-844D-8A10C1D55C6C,0xF4000,0x32000)
fs1 :Removable HardDisk - Alias hd25r0b blk1
      PciRoot(0x0)/Pci(0x14,0x0)/USB(0x11,0x0)/HD(1,MBR,0x00DD3D80,0x3F,0xEB5FC1)
fs2 :Removable BlockDevice - Alias f25s0 blk2
      PciRoot(0x0)/Pci(0x14,0x0)/USB(0x12,0x0)
blk0 :HardDisk - Alias hd33e0a2 fs0
      PciRoot(0x0)/Pci(0x17,0x0)/Sata(0x4,0x0,0x0)/HD(2,GPT,0AC3B829-99B0-4FDE-844D-8A10C1D55C6C,0xF4000,0x32000)
blk1 :Removable HardDisk - Alias hd25r0b fs1
      PciRoot(0x0)/Pci(0x14,0x0)/USB(0x11,0x0)/HD(1,MBR,0x00DD3D80,0x3F,0xEB5FC1)
blk2 :Removable BlockDevice - Alias f25s0 fs2
      PciRoot(0x0)/Pci(0x14,0x0)/USB(0x12,0x0)
blk3 :HardDisk - Alias (null)
      PciRoot(0x0)/Pci(0x17,0x0)/Sata(0x4,0x0,0x0)/HD(1,GPT,5796BAEF-EC3F-447F-B4F1-21EB08DC5D57,0x800,0xF9800)
blk4 :HardDisk - Alias (null)
      PciRoot(0x0)/Pci(0x17,0x0)/Sata(0x4,0x0,0x0)/HD(3,GPT,7C8FF3C6-53E8-4CF9-8141-65DF7EF04399,0x12C000,0x8000)
blk5 :HardDisk - Alias (null)
      PciRoot(0x0)/Pci(0x17,0x0)/Sata(0x4,0x0,0x0)/HD(4,GPT,1AABAEC6-BE17-4C27-AF60-E6C69977AC02,0x134000,0x3A6E800)
blk6 :BlockDevice - Alias (null)
      PciRoot(0x0)/Pci(0x17,0x0)/Sata(0x4,0x0,0x0)
blk7 :Removable BlockDevice - Alias (null)
      PciRoot(0x0)/Pci(0x14,0x0)/USB(0x11,0x0)
```

7. Go each **fsx** (x means number), then type **ls** to view the content of the boot device. If find the upgrade file, execute it

```
fs0:\> fs1:
fs1:\> ls
Directory of: fs1:\
06/27/19 11:43a <DIR>          16,384  efi
06/13/19 11:10a                17,974,704  820C100S16 efi
1 File(s) 17,974,704 bytes
1 Dir(s)
```



ATTENTION

Do NOT switch off the power supply during the BIOS upgrade, since doing so may cause the system to crash.

A

Regulatory Approval Statement



This device complies with part 15 of the FCC Rules. Operation is subject to the following two conditions: (1) This device may not cause harmful interference, and (2) this device must accept any interference received, including interference that may cause undesired operation.

Class A : FCC Warning! This equipment has been tested and found to comply with the limits for a Class A digital device, pursuant to part 15 of the FCC Rules. These limits are designed to provide reasonable protection against harmful interference when the equipment is operated in a commercial environment. This equipment generates, uses, and can radiate radio frequency energy and, if not installed and used in accordance with the instruction manual, may cause harmful interference to radio communications. Operation of this equipment in a residential area is likely to cause harmful interference in which case the user will be required to correct the interference at his own expense.



European Community

Warning:

This is a class A product. In a domestic environment this product may cause radio interference in which case the user may be required to take adequate measures.