

EDS-G509 Series Quick Installation Guide

Moxa EtherDevice™ Switch

Version 5.2, January 2021

Technical Support Contact Information
www.moxa.com/support

MOXA®

© 2021 Moxa Inc. All rights reserved.

P/N: 1802005090016



Package Checklist

The Moxa EDS-G509 is shipped with the following items. If any of these items is missing or damaged, please contact your customer service representative for assistance.

- 1 EDS-G509 EtherDevice Switch
- RJ45 to DB9 console port cable
- Protective caps for unused ports
- Wall Mounting Kit (optional—must be ordered separately)
- Quick installation guide (printed)
- Warranty card

Mounting Dimensions

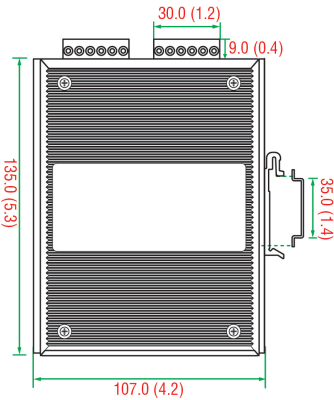

Side View

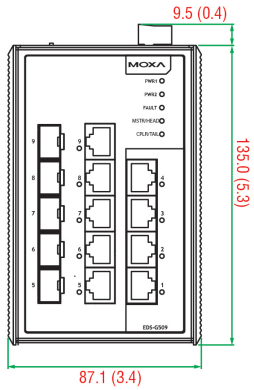

Front View

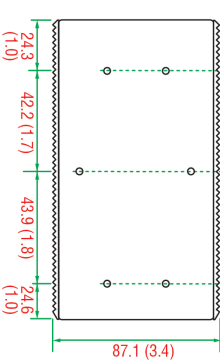

Rear View

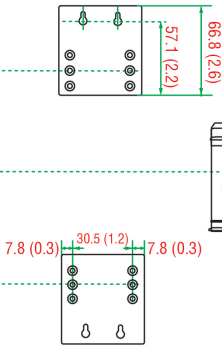

Wall Mounting Kit

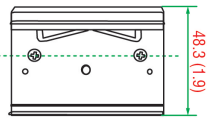

Din-Rail Kit

Unit = mm (inch)

Panel Views of EDS-G509

Front Panel View

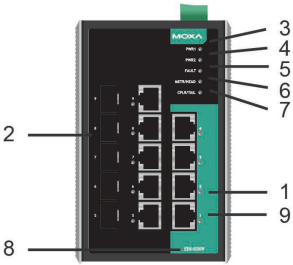

Front Panel:

1. 1 to 4: 10/100/1000 BaseT(X) port
2. 5 to 9: 10/100/1000 BaseT(X) or 10/1000Base SFP slot combo ports
3. PWR1: LED for power input 1
4. PWR2: LED for power input 2
5. FAULT: LED indicator
6. MSTR/HEAD LED
7. CPLR/TAIL LED
8. Model Name
9. 10/100/1000BaseT(X) LED indicator (Amber: 10/100M Green: 1000M)

Top Panel View

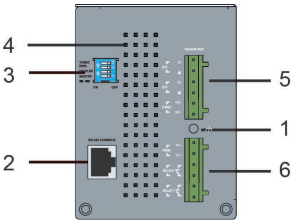

Top Panel:

1. Grounding screw
2. RS-232 console port
3. DIP switches for Ring Master, Ring Coupler, and Turbo Ring
4. Heat dissipation orifices
5. 6-pin terminal block for DI 1, DI 2, and PWR 2
6. 6-pin terminal block for PWR1, Relay 1, and Relay 2

Rear Panel View

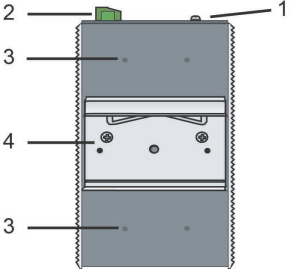

Rear Panel:

1. Grounding screw
2. Terminal block
3. Screw holes for Wall Mounting Kit
4. DIN-Rail kit

DIN-Rail Mounting

The aluminum DIN-Rail attachment plate should already be fixed to the back panel of the EDS-G509 when you take it out of the box. If you need to reattach the DIN-Rail attachment plate to the EDS-G509, make sure the stiff metal spring is situated towards the top, as shown in the following figures.

STEP 1—Insert the top of the DIN-Rail into the slot just below the stiff metal spring.

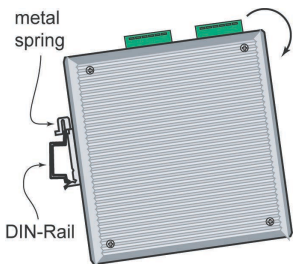

STEP 2—The DIN-Rail attachment unit will snap into place as shown in the following illustration.

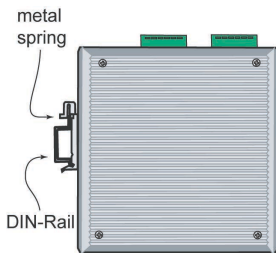

To remove the EDS-G509 from the DIN-Rail, simply reverse Steps 1 and 2 above.

Wall Mounting (Optional)

For some applications, you will find it convenient to mount the Moxa EDS-G509 on the wall, as shown in the following illustrations:

STEP 1—Remove the aluminum DIN-rail attachment plate from the rear panel of the EDS-G509, and then attach the wall-mounting plates with M3 screws, as shown in the figure at the right.

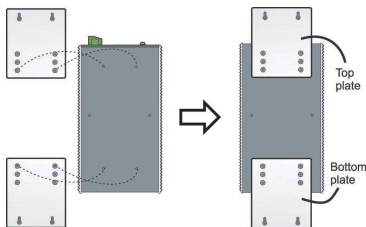

STEP 2—Mounting the EDS-G509 on the wall requires 4 screws. Use the EDS-G509, with wall-mounting plates attached, as a guide to mark the correct locations of the 4 screws. The heads of the screws should be less than 6.0 mm in diameter, and the shafts should be less than 3.5 mm in diameter, as shown in the figure on at right.

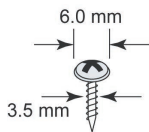

NOTE Before tightening the screws into the wall, make sure the screw head and shank size are suitable by inserting the screw through one of the keyhole-shaped apertures of the wall-mounting plates.

Do not screw the screws in all the way—leave about 2 mm to allow room for sliding the wall-mounting panel between the wall and the screws.

STEP 3—Once the screws are fixed to the wall, insert the four screw heads through the wide parts of the keyhole-shaped apertures, and then slide the EDS-G509 downwards, as indicated in the figure at the right. Tighten the four screws for more stability.

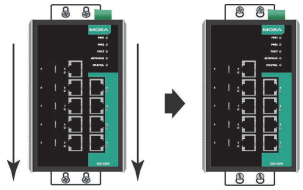

Wiring Requirements



WARNING

Do not disconnect modules or wires unless power has been switched off or the area is known to be non-hazardous. The devices may only be connected to the supply voltage shown on the type plate. The devices are designed for operation with a Safety Extra-Low Voltage. Thus, they may only be connected to the supply voltage connections and to the signal contact with the Safety Extra-Low Voltages (SELV) in compliance with IEC950/EN60950-1/ VDE0805.



ATTENTION

This unit is a built-in type. When the unit is installed in another piece of equipment, the equipment enclosing the unit must comply with fire enclosure regulation IEC 60950-1/EN60950-1 (or similar regulation).



ATTENTION

Safety First!

Be sure to disconnect the power cord before installing and/or wiring your Moxa EtherDevice Switch.

Calculate the maximum possible current in each power wire and common wire. Observe all electrical codes dictating the maximum current allowable for each wire size.

If the current goes above the maximum ratings, the wiring could overheat, causing serious damage to your equipment.

Please read and follow these guidelines:

- Use separate paths to route wiring for power and devices. If power wiring and device wiring paths must cross, make sure the wires are perpendicular at the intersection point.
NOTE: Do not run signal or communications wiring and power wiring through the same wire conduit. To avoid interference, wires with different signal characteristics should be routed separately.
- You can use the type of signal transmitted through a wire to determine which wires should be kept separate. The rule of thumb is that wiring sharing similar electrical characteristics can be bundled together
- You should separate input wiring from output wiring
- We advise that you label the wiring to all devices in the system.

Grounding the Moxa EDS-G509

Grounding and wire routing help limit the effects of noise due to electromagnetic interference (EMI). Run the ground connection from the ground screw to the grounding surface prior to connecting devices.



ATTENTION

This product is intended to be mounted to a well-grounded mounting surface such as a metal panel.

Wiring the Relay Contact

The EDS-G509 has two sets of relay outputs—relay 1 and relay 2. Each relay contact uses two contacts of the terminal block on the EDS-G509's top panel. Refer to the next section for detailed instructions on how to connect the wires to the terminal block connector, and how to attach the terminal block connector to the terminal block receptor.

In this section, we illustrate the meaning of the two contacts used to connect the relay contact.

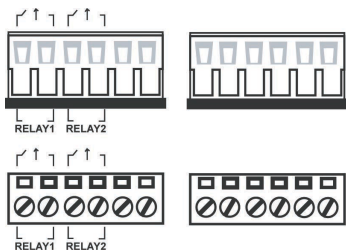

FAULT: The two sets of relay contacts of the 6-pin terminal block connector are used to detect user-configured events. The two wires attached to the fault contacts form an open circuit when a user-configured event is triggered. If a user-configured event does not occur, the fault circuit remains closed.

Wiring the Redundant Power Inputs

The EDS-G509 has two sets of power inputs—power input 1 and power input 2. The top two contacts and the bottom two contacts of the 6-pin terminal block connector on the EDS-G509’s top panel are used for the two digital inputs. The top and front views of one of the terminal block connectors are shown here.

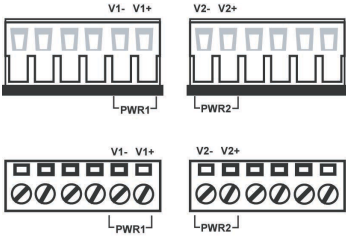

- STEP 1:** Insert the negative/positive DC wires into the V-/V+ terminals, respectively.
- STEP 2:** To keep the DC wires from pulling loose, use a small flat-blade screwdriver to tighten the wire-clamp screws on the front of the terminal block connector.
- STEP 3:** Insert the plastic terminal block connector prongs into the terminal block receptor, which is located on the EDS-G509’s top panel.

Wiring the Digital Inputs

The EDS-G509 has two sets of digital inputs, DI 1 and DI 2. Each DI consists of two contacts of the 6-pin terminal block connector on the EDS-G509’s top panel, which are used for the two DC inputs. The top and front views of one of the terminal block connectors are shown here.

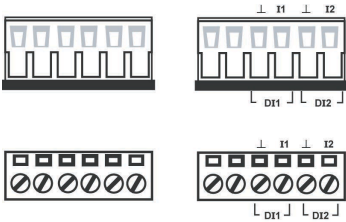

- STEP 1:** Insert the negative (ground)/positive DI wires into the \perp /I1 terminals, respectively.
- STEP 2:** To keep the DI wires from pulling loose, use a small flat-blade screwdriver to tighten the wire-clamp screws on the front of the terminal block connector.
- STEP 3:** Insert the plastic terminal block connector prongs into the terminal block receptor, which is located on the EDS-G509’s top panel.

Communication Connections

Each EDS-G509 switch has 3 types of communication port:

- 1 RJ45 console port (RS-232 interface)
- 4 10/100/1000BaseTX Ethernet ports
- 5 combination 10/100/1000T(X)/1000BaseSFP ports

RS-232 Connection

The EDS-G509 has one RS-232 (10-pin RJ45) console port, located on the top panel. Use either an RJ45-to-DB9 (see the cable following wiring diagrams) to connect the EDS-G509’s console port to your PC’s COM port. You may then use a console terminal software, such as Moxa PComm Terminal Emulator, to access the EDS-G509’s serial console. (Baudrate: 115200 bps, no parity, 8 data bit, 1 stop bit)

RJ45 (10-pin) Console Port Pinouts

Pin	Description
1	-
2	DSR
3	RTS
4	-
5	TxD
6	RxD
7	GND
8	CTS
9	DTR
10	-

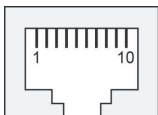

RJ45 (10-pin) to DB9 (F) Cable Wiring

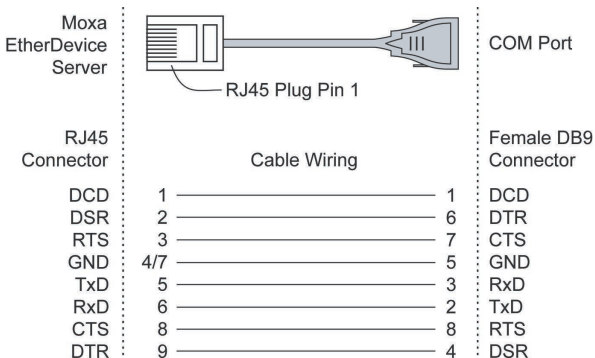

10/100/1000BaseT(X) Ethernet Port Connection

The 10/100/1000BaseT(X) ports located on Moxa EtherDevice Switch's front panel are used to connect to Ethernet-enabled devices. Most users will choose to configure these ports for Auto MDI/MDI-X mode, in which case the port's pinouts are adjusted automatically depending on the type of Ethernet cable used (straight-through or cross-over), and the type of device (NIC-type or HUB/Switch-type) connected to the port.

In what follows, we give pinouts for both MDI (NIC-type) ports and MDI-X (HUB/Switch-type) ports. We also give cable wiring diagrams for straight-through and cross-over Ethernet cables.

10/100Base T(x) RJ45 Pinouts

MDI Port Pinouts

Pin	Signal
1	Tx+
2	Tx-
3	Rx+
6	Rx-

MDI-X Port Pinouts

Pin	Signal
1	Rx+
2	Rx-
3	Tx+
6	Tx-

8-pin RJ45

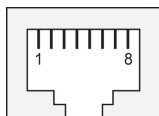

1000BaseT RJ45 Pinouts

Pin	MDI	MDI-X
1	BI_DA+	BI_DB+
2	BI_DA-	BI_DB-
3	BI_DB+	BI_DA+
4	BI_DC+	BI_DD+
5	BI_DC-	BI_DD-
6	BI_DB-	BI_DA-
7	BI_DD+	BI_DC+
8	BI_DD-	BI_DC-

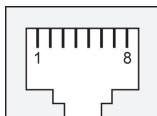

RJ45 (8-pin) to RJ45 (8-pin) Straight-Through Cable Wiring

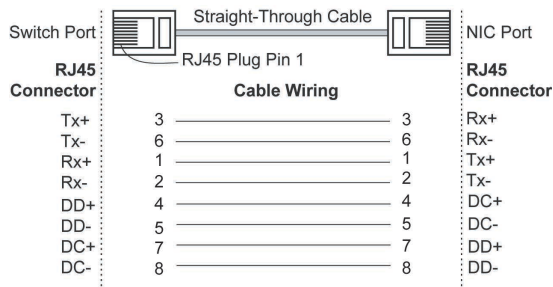

RJ45 (8-pin) to RJ45 (8-pin) Cross-Over Cable Wiring

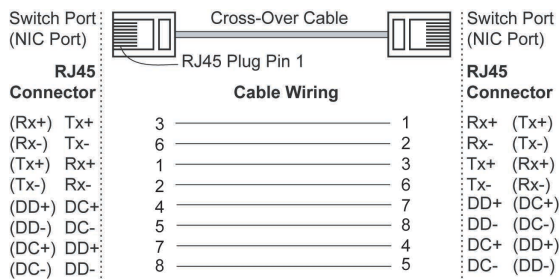

100BaseFX or 1000BaseSFP Fiber Port

The Gigabit Ethernet ports on the EDS-G509 series are SFP slots, which require 100BaseFX SFP or Gigabit mini-GBIC fiber transceivers to work properly. Moxa provides complete transceiver models for various distance requirements.

Multi-mode:

1000BaseSX	0 to 550 m, 850 nm (50/125 μ m, 400 MHz * km)
	0 to 275 m, 850 nm (62.5/125 μ m, 200 MHz * km)
1000BaseLX	0 to 1100 m, 1310 nm (50/125 μ m, 800 MHz * km)
	0 to 550 m, 1310 nm (62.5/125 μ m, 500 MHz * km)

Single mode:

1000BaseLH	0 to 10 km, 1310 nm (9/125 μ m, 3.5 PS/(nm * km))
1000BaseLHX	0 to 40 km, 1310 nm (9/125 μ m, 3.5 PS/(nm * km))
1000BaseZX	0 to 80 km, 1550 nm (9/125 μ m, 19 PS/(nm * km))

Multi-mode:

100BaseFX 0 to 5 km, 1300 nm (50/125 μm , 800 MHz * km)
0 to 4 m, 1300 nm (62.5/125 μm , 500 MHz * km)

Single mode:

100BaseFX 0 to 40 km, 1310 nm (9/125 μm , 3.5 PS/(nm * km))

The concept behind the LC port and cable is quite straightforward. Suppose you are connecting devices I and II. Unlike electrical signals, optical signals do not require a circuit in order to transmit data. Consequently, one of the optical lines is used to transmit data from device I to device II, and the other optical line is used to transmit data from device II to device I, for full-duplex transmission.

Remember to connect the Tx (transmit) port of device I to the Rx (receive) port of device II, and the Rx (receive) port of device I to the Tx (transmit) port of device II. If you make your own cable, we suggest labeling the two sides of the same line with the same letter (A-to-A and B-to-B, as shown below, or A1-to-A2 and B1-to-B2).

LC-Port Pinouts

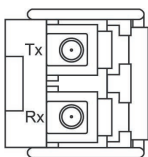

LC-Port to LC-Port Cable Wiring

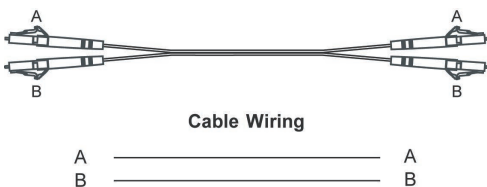

ATTENTION

This is a Class 1 Laser/LED product. To avoid causing serious damage to your eyes, do not stare directly into the Laser Beam.

Turbo Ring DIP Switch Settings

EDS-G509 series are plug-and-play managed redundant Ethernet switches. The proprietary Turbo Ring protocol was developed by Moxa to provide better network reliability and faster recovery time. Moxa Turbo Ring's recovery time is less than 300 ms (**Turbo Ring**) or less than 50 ms @ 250 switches (**Turbo Ring V2**)—compared to a 3- to 5-minute recovery time for commercial switches—decreasing the possible loss caused by network failures in an industrial setting.

There are 4 Hardware DIP Switches for Turbo Ring on the top panel of EDS-G509 that can help setup the Turbo Ring easily within seconds. If you do not want to use a hardware DIP switch to setup the Turbo Ring, you can use a web browser, telnet, or console to disable this function.

NOTE Please refer to the **Turbo Ring DIP Switch** section and **Using Communication Redundancy** section in the User's Manual for more detail information about the settings and usage of **Turbo Ring** and **Turbo Ring V2**.

EDS-G509 Series DIP Switches

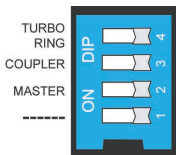

The default setting for each DIP Switch is OFF. The following table explains the effect of setting the DIP Switch to the ON position.

"Turbo Ring" DIP Switch Settings

DIP 1	DIP 2	DIP 3	DIP 4
Reserved for future use.	<u>ON</u> : Enables this EDS as the Ring Master.	<u>ON</u> : Enables the default "Ring Coupling" ports.	<u>ON</u> : Activates DIP switches 1, 2, 3 to configure "Turbo Ring" settings.
	<u>OFF</u> : This EDS will not be the Ring Master.	<u>OFF</u> : Do not use this EDS as the ring coupler.	<u>OFF</u> : DIP switches 1, 2, 3 will be disabled.

"Turbo Ring V2" DIP Switch Settings

DIP 1	DIP 2	DIP 3	DIP 4
<u>ON</u> : Enables the default "Ring Coupling (backup)" port.	<u>ON</u> : Enables this EDS as the Ring Master.	<u>ON</u> : Enables the default "Ring Coupling" port.	<u>ON</u> : Activates DIP switches 1, 2, 3 to configure "Turbo Ring V2" settings.
<u>OFF</u> : Enables the default "Ring Coupling (primary)" port.	<u>OFF</u> : This EDS will not be the Ring Master.	<u>OFF</u> : Do not use this EDS as a ring coupler.	<u>OFF</u> : DIP switches 1, 2, 3 will be disabled.

NOTE You must enable the Turbo Ring function first before using the DIP switch to activate the Master and Coupler functions.

NOTE If you do not enable any of the EDS-G509 switches to be the Ring Master, the Turbo Ring protocol will automatically choose the EDS-G509 with the smallest MAC address range to be the Ring Master. If you accidentally enable more than one EDS-G509 to be the Ring Master, these EDS-G509 switches will auto-negotiate to determine which one will be the Ring Master.

LED Indicators

The front panel of the Moxa EDS-G509 contains several LED indicators. The function of each LED is described in the following table:

LED	Color	State	Description
PWR1	AMBER	On	Power is being supplied to power input P1.
		Off	Power is not being supplied to power input P1.
PWR2	AMBER	On	Power is being supplied to power input P2.
		Off	Power is not being supplied to power input P2.
FAULT	RED	On	When the corresponding PORT alarm is enabled, and a user-configured event is triggered.
		Off	When the corresponding PORT alarm is enabled and a user-configured event is not triggered, or when the corresponding PORT alarm is disabled.
MSTR/HEAD	GREEN	On	When the EDS-G509 is set as the Master of the Turbo Ring, or as the Head of the Turbo Chain.
		Blinking	The EDS-G509 has become the Ring Master of the Turbo Ring, or the Head of the Turbo Chain, after the Turbo Ring or the Turbo Chain is down.
		Off	When the EDS-G509 is not the Master of this Turbo Ring or is set as the Member of the Turbo Chain.
CPLR/TAIL	GREEN	On	When the EDS-G509 coupling function is enabled to form a back-up path, or when it's set as the Tail of the Turbo Chain.
		Blinking	When the Turbo Chain is down.
		Off	When the EDS-G509 disables the coupling function.
10/100/1000M	AMBER	On	TP port's 10/100 Mbps link is active.
		Blinking	Data is being transmitted at 10/100 Mbps.
		Off	TP port's 10/100 Mbps link is inactive.
	GREEN	On	TP port's 1000 Mbps link is active.
		Blinking	Data is being transmitted at 1000 Mbps.
		Off	TP port's 1000 Mbps link is inactive.

Specifications

Technology							
Standards	IEEE802.3, 802.3u, 802.3x, 802.1D, 802.1w, 802.1Q, 802.1p, 802.1X, 802.3ad, 802.3z						
Protocols	IGMPv1/v2, GMRP, GVRP, SNMPv1/v2c/v3, DHCP Server/Client, DHCP Option 66/67/82, BootP, TFTP, SNTP, SMTP, RARP, RMON, HTTP, HTTPS, Telnet, SSH, Syslog, Modbus/TCP, SNMP Inform, LLDP, IEEE 1588 PTP, IPv6						
MIB	MIB-II, Ethernet-like MIB, P-BRIDGE MIB, Q-BRIDGE MIB, Bridge MIB, RSTP MIB, RMON MIB Group 1,2,3,9						
Flow Control	IEEE802.3x flow control/back pressure						
Interface							
RJ45 Ports	10/100/1000BaseT(X) auto negotiation speed, F/H duplex mode, and auto MDI/MDI-X connection						
Fiber Ports	optional 1000BaseSX/LX/LHX/ZX (LC connector)						
Console Port	RS-232 (10-pin RJ45)						
LED Indicators	PWR1, PWR2, FAULT, 10/100M (TP port), 1000M, MSTR/HEAD and CPLR/TAIL						
Alarm Contact	Two relay outputs with current carrying capacity of 1A @ 24 VDC						
Digital Input	Two inputs with the same ground, but electrically isolated from the electronics <ul style="list-style-type: none"> • For state "1": +13 to +30 V • For state "0": -30 to +3 V • Max. input current: 8 mA 						
Optical Fiber—100 or 1000Base SFP modules							
	Gigabit Ethernet						
	SFP-SX	SFP-LSX	SFP-LX	SFP-LH	SFP-LHX	SFP-ZX	SFP-EZX
Wave-length	850 nm	1310 nm	1310 nm	1310 nm	1310 nm	1550 nm	1550 nm
Max. Tx	-4 dBm	-1 dBm	-3 dBm	-2 dBm	1 dBm	5 dBm	5 dBm
Min. Tx	-9.5 dBm	-9 dBm	-9.5 dBm	-8 dBm	-4 dBm	0 dBm	0 dBm
Rx Sensitivity	-18 dBm	-19 dBm	-20 dBm	-23 dBm	-24 dBm	-24 dBm	-30 dBm
Link Budget	8.5 dB	10 dB	10.5 dB	15 dB	20 dB	24 dB	30 dB
Typical Distance	550 m ^a	2 km ^b	10 km ^c	30 km ^c	40 km ^c	80 km ^c	110 km ^c
Saturation	0 dBm	-3 dBm	-3 dBm	-3 dBm	-3 dBm	-3 dBm	-3 dBm
a. 50/125 μm, 400 MHz * km or 62.5/125 μm, 500 MHz * km @ 850 nm multi-mode fiber optic cable b. 62.5/125 μm, 750 MHz * km @ 1310 nm multi-mode fiber optic cable c. 9/125 μm single-mode fiber optic cable							

	Fast Ethernet		
	SFP-M	SFP-S	SFP-L
Wavelength	1300 nm	1310 nm	1550 nm
Max. Tx	-18 dBm	0 dBm	0 dBm
Min. Tx	-8 dBm	-5 dBm	-5 dBm
Rx Sensitivity	-34 dBm	-34 dBm	-34 dBm
Link Budget	26 dB	29 dB	29 dB
Typical Distance	4 km ^a	40 km ^b	80 km ^b
Saturation	0 dBm	-3 dBm	-3 dBm
a. 50/125 μm or 62.5/125 μm, 800 MHz * km @ 1300 nm multi-mode fiber optic cable			
b. 9/125 μm single-mode fiber optic cable			
Power			
Input Voltage	12/24/48 VDC, 18 to 30 VAC (47 to 63 Hz), redundant inputs		
Input Current (@24V)	0.92 A		
Connection	Two removable 6-pin terminal blocks		
Overload Current Protection	Present		
Reverse Polarity Protection	Present		
Mechanical			
Casing	IP30 protection, metal case		
Dimensions (W x H x D)	87.1 x 135 x 107 mm (3.43 x 5.31 x 4.21 in)		
Weight	1.41 kg		
Installation	DIN-Rail, Wall Mounting Kit (optional kit)		
Environment			
Operating Temperature	0 to 60°C (32 to 140°F), standard models -40 to 75°C (-40 to 167°F) for -T models		
Storage Temperature	-40 to 85°C (-40 to 185°F)		
Ambient Relative Humidity	5 to 95% (non-condensing)		
Regulatory Approvals			
Safety	UL 508		
Hazardous Location	UL/cUL Class I, Division 2, Groups A, B, C, and D; ATEX Class I, Zone 2, Ex nC nL IIC T4		
EMI	FCC Part 15, EN55032; class A		
EMS	EN55024 EN61000-4-2 (ESD), Level 3 EN61000-4-3 (RS), Level 3 EN61000-4-4 (EFT), Level 2 EN61000-4-5 (Surge), Level 3 EN61000-4-6 (CS), Level 3 EN61000-4-8 EN61000-4-11		
Shock	IEC60068-2-27		
Free Fall	IEC60068-2-32		
Vibration	IEC60068-2-6		
WARRANTY	5 years		