

# DA-681A Series Embedded Computer Hardware User's Manual

---

Edition 1.0, November 2015

[www.moxa.com/product](http://www.moxa.com/product)

**MOXA**<sup>®</sup>

© 2015 Moxa Inc. All rights reserved.

# DA-681A Series Embedded Computer Hardware User's Manual

The software described in this manual is furnished under a license agreement and may be used only in accordance with the terms of that agreement.

## Copyright Notice

© 2015 Moxa Inc. All rights reserved.

## Trademarks

The MOXA logo is a registered trademark of Moxa Inc.  
All other trademarks or registered marks in this manual belong to their respective manufacturers.

## Disclaimer

Information in this document is subject to change without notice and does not represent a commitment on the part of Moxa.

Moxa provides this document as is, without warranty of any kind, either expressed or implied, including, but not limited to, its particular purpose. Moxa reserves the right to make improvements and/or changes to this manual, or to the products and/or the programs described in this manual, at any time.

Information provided in this manual is intended to be accurate and reliable. However, Moxa assumes no responsibility for its use, or for any infringements on the rights of third parties that may result from its use.

This product might include unintentional technical or typographical errors. Changes are periodically made to the information herein to correct such errors, and these changes are incorporated into new editions of the publication.

## Technical Support Contact Information

[www.moxa.com/support](http://www.moxa.com/support)

### Moxa Americas

Toll-free: 1-888-669-2872  
Tel: +1-714-528-6777  
Fax: +1-714-528-6778

### Moxa Europe

Tel: +49-89-3 70 03 99-0  
Fax: +49-89-3 70 03 99-99

### Moxa India

Tel: +91-80-4172-9088  
Fax: +91-80-4132-1045

### Moxa China (Shanghai office)

Toll-free: 800-820-5036  
Tel: +86-21-5258-9955  
Fax: +86-21-5258-5505

### Moxa Asia-Pacific

Tel: +886-2-8919-1230  
Fax: +886-2-8919-1231

# Table of Contents

<b>1. Introduction</b>	<b>1-1</b>
Overview	1-2
Model Descriptions and Package Checklist	1-2
Comparison of DA-Series Models	1-2
Optional Accessories	1-3
Expansion Modules (can be purchased separately)	1-3
Optional Accessories (can be purchased separately)	1-3
Appearance	1-4
Front View	1-4
Rear View- DA-681A-DPP & DA-681A-DPP-T	1-4
Rear View- DA-681A-SP	1-4
Dimensions	1-4
Features	1-5
Hardware Block Diagram	1-5
DA-681A Basic System	1-5
Hardware Specifications	1-6
<b>2. Hardware Installation</b>	<b>2-1</b>
Placement Options	2-2
Desktop	2-2
Rack mounting	2-2
Wiring Requirements	2-3
Connecting the Power	2-4
Wiring the Power Inputs	2-5
For SP Models	2-5
For DPP and DPP-T Models	2-6
Power Input Wiring Description	2-7
Reset Button	2-8
Front Panel LED	2-8
Connecting to a Display	2-9
Connecting USB Devices	2-9
Connecting a Serial Device	2-10
LAN Ports	2-10
Connecting the IRIG-B time synchronization device (For DPP & DPP-T models only)	2-11
DA-IRIGB-4DIO-PCI104-EMC4 Pin Assignments	2-11
Connecting to the DA-IRIGB-B-S Series	2-12
Installing the Memory Module	2-14
Installing a mSATA Card	2-15
Installing a SATA Hard Disk / Solid State Disk	2-16
Installing a USB Dongle Kit	2-19
<b>3. BIOS Setup</b>	<b>3-1</b>
Entering the BIOS Setup	3-2
Main Information	3-3
Advanced Settings	3-3
Boot Configuration	3-4
HDC Configuration	3-4
Video Configuration	3-5
Chipset Configuration	3-6
Hardware Monitor	3-7
Security Settings	3-7
Set Supervisor Password	3-8
Power Settings	3-8
Auto Wake on S5	3-8
Wake on LAN	3-8
Boot Settings	3-9
Boot Type	3-9
PXE Boot to LAN	3-9
Add Boot Options	3-9
USB Boot	3-9
EFI Device First	3-9
Boot Delay Time	3-9
Legacy	3-10
Exit Settings	3-10
Exit Saving Changes	3-10
Save Change Without Exit	3-10
Exit Discarding Changes	3-10
Load Optimal Defaults	3-11
Load Custom Defaults	3-11
Save Custom Defaults	3-11

Discard Changes .....	3-11
Upgrading the BIOS .....	3-11
<b>A. Safety Installation Instructions .....</b>	<b>A-1</b>
RTC Battery Warning.....	A-1
Fuse Warning.....	A-1
Rack mount Warning.....	A-1
<b>B. Regulatory Statement Approval .....</b>	<b>B-1</b>

# Introduction

---

Thank you for purchasing the DA-681A series x86-based industrial ready-to-run embedded computer.

This manual introduces the hardware installation, connector interfaces, and BIOS setup of the DA-681A. For software configuration and management, please refer to the user's manual for your operating system.

The following topics are covered in this chapter:

- **Overview**
- **Model Descriptions and Package Checklist**
  - Comparison of DA-Series Models
  - Optional Accessories
  - Expansion Modules (can be purchased separately)
  - Optional Accessories (can be purchased separately)
- **Appearance**
  - Front View
  - Rear View- DA-681A-DPP & DA-681A-DPP-T
  - Rear View- DA-681A-SP
- **Dimensions**
- **Features**
- **Hardware Block Diagram**
  - DA-681A Basic System
- **Hardware Specifications**

## Overview

The Moxa DA-681A Series x86-based rack-mount embedded computers are designed for control, monitoring, data acquisition, and protocol conversion applications. With its robust design, the DA-681A is suitable for industrial automation applications, including power automation, transportation, and oil and gas.

The DA-681A's main operating system is based on the 3rd Gen Intel® Core™ Celeron 1047UE 1.4 GHz CPU and HM65 chipset, which supports standard x86, 1 x VGA, 4 x USB, 6 Gigabit LAN ports, 2 RS-232/422/485 3-in-1 serial ports, and 10 RS-485 (RS-422 by CV) ports. The DA-681A has a mini PCIe socket for mSATA and comes with Linux pre-installed; Windows 7 Embedded is also supported by the CTOS (Configuration To Order Service) process.

Another plus is that the serial ports come with 2 kV digital galvanic isolation protection to guarantee communication reliability in harsh industrial environments. In addition, the state-of-art IEC 61850-3, IEEE 1613, and IEC 60255 compliance all-in-one design provides rich interfaces especially well-suited for power substation automation applications.

## Model Descriptions and Package Checklist

The DA-681A Series includes the following models:

### DA-681A-I-SP:

6 Ethernet ports, VGA, 2 RS-232/422/485 ports, 10 RS-485 ports, mSATA, SATA, USB, Single Power (RAM, mSATA, OS not included), -25 to 55°C operating temperature

### DA-681A-I-SP-LX:

6 Ethernet ports, VGA, 2 RS-232/422/485 ports, 10 RS-485 ports, mSATA, SATA, USB, Single Power, Linux Debian 8., -25 to 55°C operating temperature

### DA-681A-I-DPP:

IEC 61850-3 computer with VGA, 6 LAN ports, 2 RS-232/422/485 ports, 10 RS-485 ports, mSATA, SATA, USB, dual power (RAM, mSATA, OS not included), -25 to 55°C operating temperature

### DA-681A-I-DPP-LX:

IEC 61850-3 computer with VGA, 6 LAN ports, 2 RS-232/422/485 ports, 10 RS-485 ports, mSATA, SATA, USB, dual power, Linux Debian 8, -25 to 55°C operating temperature

### DA-681A-I-DPP-T:

IEC 61850-3 computer with VGA, 6 LAN ports, 2 RS-232/422/485 ports, 10 RS-485 ports, mSATA, SATA, USB, dual power (RAM, mSATA, OS not included), -40 to 70°C operating temperature

### DA-681A-I-DPP-T-LX:

IEC 61850-3 computer with VGA, 6 LAN ports, 2 RS-232/422/485 ports, 10 RS-485 ports, mSATA, SATA, USB, dual power, Linux Debian 8, -40 to 70°C operating temperature

## Comparison of DA-Series Models

Model Name	Serial Ports		Giga LAN Ports	Storage			Expansion PCI-104 (for IRIG-B)	System			Power	Relay	IEC 61850-3 IEEE 1613 IEC 60255
	3-in-1	RS-485		SATA	mSATA	USB		OS	RAM	mSATA			
DA-681A-I-SP	2	10	6	1	1	4	–	–	–	–	1	–	–
DA-681A-I-SP-LX	2	10	6	1	1	4	–	Linux	2G	8G	1	–	–
DA-681A-I-DPP	2	10	6	1	1	4	1	–	–	–	2	1	✓
DA-681A-I-DPP-LX	2	10	6	1	1	4	1	Linux	2G	8G	2	1	✓
DA-681A-I-DPP-T	2	10	6	1	1	4	1	–	–	–	2	1	✓
DA-681A-I-DPP-T-LX	2	10	6	1	1	4	1	Linux	2G	8G	2	1	✓

Each model is shipped with following standard items:

- DA-681A rackmount computer
- Rackmount kit
- Documentation CD or DVD
- Quick installation guide (printed)
- Warranty card



### Optional Accessories

Model Name	Expansion Module Support	Accessories	
	DA-IRIGB-4DIO-PCI104-EMC4	USB Dongle	DA-681A HDD Kit
DA-681A-I-SP	–	✓	✓
DA-681A-I-SP-LX	–	✓	✓
DA-681A-I-DPP	✓	✓	✓
DA-681A-I-DPP-LX	✓	✓	✓
DA-681A-I-DPP-T	✓	✓	✓
DA-681A-I-DPP-T-LX	✓	✓	✓

### Expansion Modules (can be purchased separately)

	Model	Description
	DA-IRIGB-4DIO-PCI104-EMC4	Time synchronization expansion module, 1 IRIG-B signal input port, 3 digital inputs, 4 digital outputs (DA-681A-I-DPP series only)

### Optional Accessories (can be purchased separately)

	Model	Description
	DA-681A HDD Kit	The HDD/SSD installation package, supports single HDD/SSD.
	USB Dongle Kit	The USB dongle kit can be installed inside the DA-681A and is suitable for security applications. For example, it can be used to store a SCADA license or for storing the Smart Recovery backup image.

# Appearance



## Front View

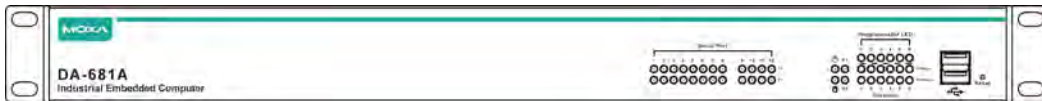

## Rear View- DA-681A-DPP & DA-681A-DPP-T

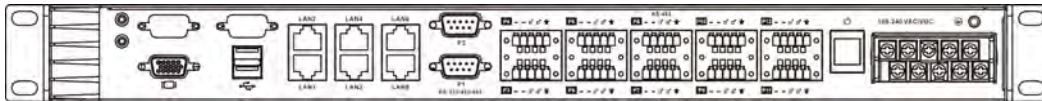

## Rear View- DA-681A-SP

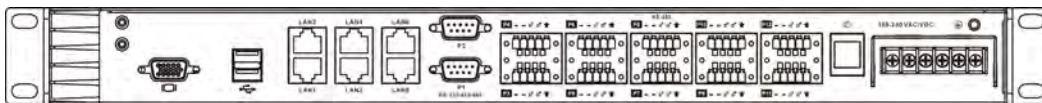

# Dimensions

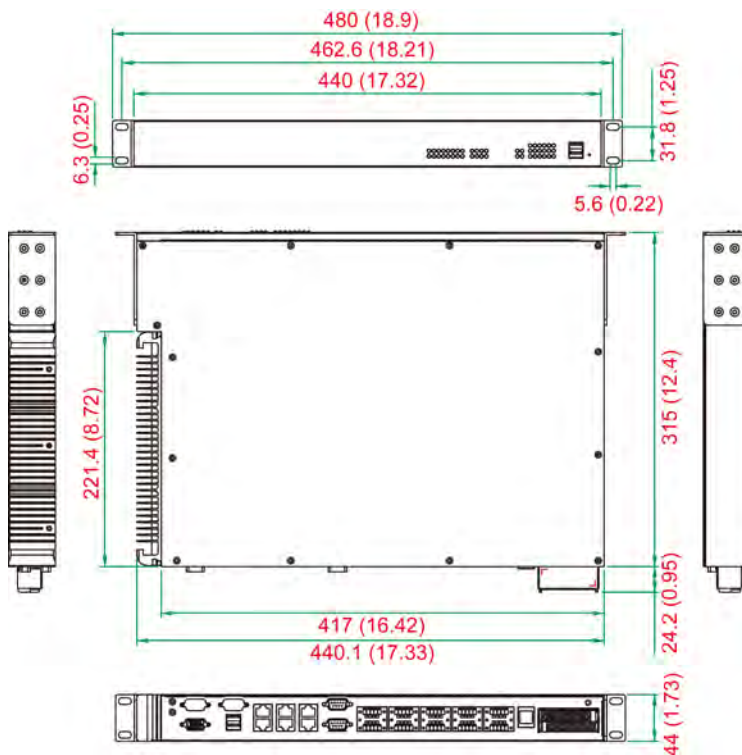



# Features

The DA-681A Basic System has the following features:

- IEC 61850-3, IEEE 1613, and IEC 60255 compliant for power substation automation systems (DPP and DPP-T models only)
- 3rd Gen Intel® Core™ Celeron 1047UE 1.4 GHz CPU
- 1 built-in DDR3 memory socket
- 1 mSATA for OS and 1 SATA II for storage expansion
- 6 Gigabit Ethernet ports for network redundancy
- 4 USB 2.0 ports for high speed peripherals
- 2 isolated RS-232/422/485 and 10 isolated RS-485 ports
- Embedded Debian 8 Linux (W7E by CTOS)
- Supports both 100 to 240 VAC and VDC power inputs (single power and dual power models available)
- Optional IRIG-B expansion module available on DPP and DPP-T models

# Hardware Block Diagram

## DA-681A Basic System

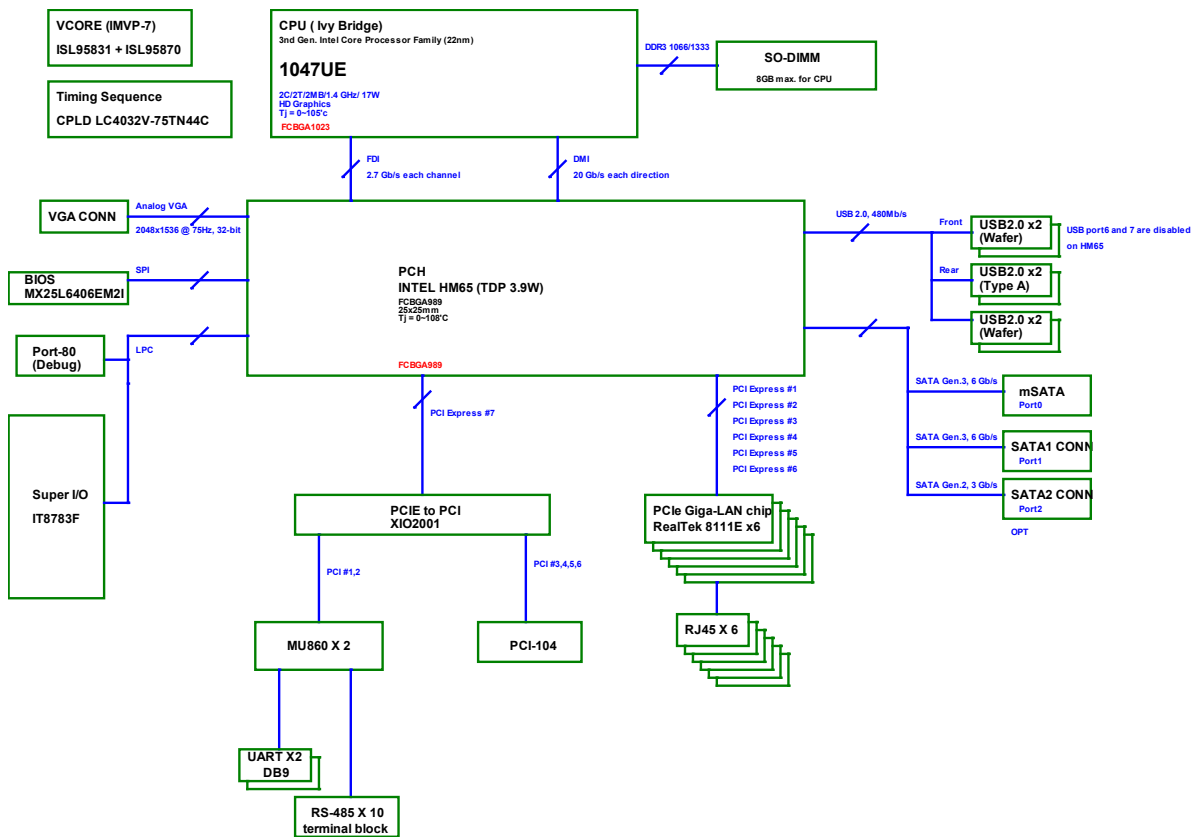

# Hardware Specifications

## Computer

**CPU:** 3rd Gen Intel® Core™ Celeron 1047UE 1.4 GHz

**OS:** Linux Debian 8 (pre-installed)

**W7E available by CTOS**

**System Chipset:** Intel HM65

**BIOS:** 64 Mbit Flash BIOS, PCI Plug & Play, ACPI

**System Memory:** 8 GB capacity, 2 GB for Linux pre-installed; 1 slot of DDR3-1066/1333 SO-DIMM SDRAM

**Expansion Bus:** PCI/104 onboard (DPP models only)

**USB:** 4 USB 2.0 ports, system bootable, type A connector

## Storage

**Built-in:** 8 GB for Linux (pre-installed in mSATA)

**Storage Expansion:** 1 SATA 3.0 interface connector

## Display

**Graphics Controller:** Intel® HD Graphics (Integrated)

**Display Memory:** Dynamic video memory (shares up to 32 MB of system memory)

**Display Interface:** CRT Interface for VGA output (DB15 female connector)

**Resolution:** CRT display mode with pixel resolution up to 2048 x 1536 at 75 Hz

## Ethernet Interface

**LAN:** 6 auto-sensing 10/100/1000 Mbps ports

**Magnetic Isolation Protection:** 1.5 kV built-in

## Serial Interface

**Serial Standards:**

- 2 RS-232/422/485 ports (DB9 male)
- 10 RS-485 ports (terminal block)

**ESD Protection:** 15 kV for all signals

**Surge Protection:** 4 kV (DPP & DPP-T only)

**Isolation:** 2 kV digital galvanic isolation

## Serial Communication Parameters

**Data Bits:** 5, 6, 7, 8

**Stop Bits:** 1, 1.5, 2

**Parity:** None, Even, Odd, Space, Mark

**Flow Control:** RTS/CTS, XON/XOFF

**Baudrate:** 50 bps to 115.2 kbps

## Serial Signals

**RS-232:** TxD, RxD, DTR, DSR, RTS, CTS, DCD, GND

**RS-422:** TxD+, TxD-, RxD+, RxD-, GND

**RS-485-4w:** TxD+, TxD-, RxD+, RxD-, GND

**RS-485-2w:** Data+, Data-, GND

## LEDs

**System:** Power, Storage

**LAN:** 100M x 6, 1000M x 6

**Serial:**

RS-232/422/485: 2 x Tx, 2 x Rx

RS-485: 10 x Tx, 10 x Rx

**Programmable:** 6 LEDs

**Power Failure:** LED x 2 (dual power models)

## Switches and Buttons

**Power Button:** On/Off (on rear panel)

**Reset Button:** Hard Reset (on front panel)

### Physical Characteristics

**Housing:** SECC sheet metal (1 mm)

**Weight:** 4.5 kg

**Dimensions:** 440 x 315 x 45 mm (17.32 x 12.40 x 1.77 in), 19 inch 1U height

**Mounting:** Standard 19-inch rackmount

### Environmental Limits

#### Operating Temperature:

SP Models: -25 to 55°C (-13 to 131°F)

DPP Models: -25 to 55°C (-13 to 131°F)

DPP-T Models: -40 to 70°C (-40 to 158°F)

#### Storage Temperature:

-40 to 85°C (-40 to 185°F)

**Ambient Relative Humidity:** 5 to 95% (non-condensing)

**Anti-Vibration:** 7 mm (2-9 Hz), 20 m/s/s (9-200 Hz), 15 m/s/s (200-500 Hz) @ IEC-61850-3, IEC 60870-2-2/Cm/(3M6)/(4M6), sine wave, 2-500 Hz, 1 Oct/min, 10 cycles, 2 hrs 40 mins per axis

**Anti-Shock:** 300 m/s<sup>2</sup> @ IEC-61850-3, IEC 60870-2-2/Cm/(3M6)/(4M6), half sine wave, 11 ms

### Power Requirements

**Input Voltage:** Single or dual inputs, 100 to 240 VAC/VDC auto-ranging, 47 to 63 Hz, terminal block

**Power Consumption:** 30 W

### Standards and Certifications

**Safety:** LVD, UL, cUL

**Electrical Substation:** IEC 61850-3, IEC 60255, IEEE 1613

**Protection Relay:** IEC 60255

**EMC:** FCC, CE (Class A)

**Green Product:** RoHS, CRoHS, WEEE

### Reliability

#### Alert Tools:

- Built-in buzzer and RTC (real-time clock) with battery lithium backup
- Built-in 1 relay for visual/audio alarm.

**Automatic Reboot Trigger:** Built-in watchdog timer, configurable for restarts at 1 to 255 second intervals

#### MTBF (mean time between failures):

DA-681A-I-SP: 240784 hrs

DA-681A-I-DPP: 215436 hrs

DA-681A-I-DPP-T: 215436 hrs

### Warranty

**Warranty Period:** 3 years

**Details:** See [www.moxa.com/warranty](http://www.moxa.com/warranty)



### WARNING

Communication between a serial device and a Moxa UART port may not work correctly if the serial device communicates at a baud rate that is not within the tolerance of a rate calculated from either formula A or formula B.

## Hardware Installation

---

The DA-681A Series of embedded computers are compact and rugged, making them suitable for industrial applications. The LED indicators allow users to monitor performance and identify trouble spots quickly, and multiple ports are provided for connecting a variety of different devices. The DA-681A embedded computers come with a reliable and stable hardware platform that lets you devote the bulk of your time to application development. This chapter describes hardware installation and connector interfaces of the DA-681A embedded computers.

The following topics are covered in this chapter:

- ❑ **Placement Options**
  - Desktop
  - Rack mounting
- ❑ **Wiring Requirements**
- ❑ **Connecting the Power**
- ❑ **Wiring the Power Inputs**
  - For SP Models
  - For DPP and DPP-T Models
- ❑ **Power Input Wiring Description**
- ❑ **Reset Button**
- ❑ **Front Panel LED**
- ❑ **Connecting to a Display**
- ❑ **Connecting USB Devices**
- ❑ **Connecting a Serial Device**
- ❑ **LAN Ports**
- ❑ **Connecting the IRIG-B time synchronization device (For DPP & DPP-T models only)**
  - DA-IRIGB-4DIO-PCI104-EMC4 Pin Assignments
- ❑ **Connecting to the DA-IRIGB-B-S Series**
- ❑ **Installing the Memory Module**
- ❑ **Installing a mSATA Card**
- ❑ **Installing a SATA Hard Disk / Solid State Disk**
- ❑ **Installing a USB Dongle Kit**

# Placement Options

## Desktop

Place your DA-681A on a clean, flat, well-ventilated desktop. For better ventilation, leave some space between the DA-681A and other equipment. Do not place equipment or objects on top of the DA-681A, as this might damage the computer's internal components.

## Rack mounting

The DA-681A has rack mount supports for installing the embedded computer on a standard rack.



### ATTENTION!

For maximum safety, at least two persons should work together to lift the embedded computer when mounting it into the rack.

Before you lift or move the embedded computer, make sure the power to both the rack system and the device is turned off.

Four rack mount screws are required to attach the DA-681A to a standard rack.



Follow these steps to install the DA-681A on a rack.

### Step 1: Installing the rack mount supports.

Take the rack mount supports out of the packages: there are two ears and 12 screws (one ear and one set of screws are shown at right). Each ear requires 6 screws to attach to the rack.

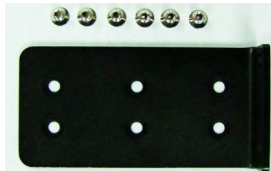

### Step 2: Installing the rack mount ears to the DA-681A.

Use 6 screws to attach one mounting ear to one side of the DA-681A, as shown at right. Repeat this procedure for the other side of the DA-681A.



**Step 3: Installing the DA-681A to a rack.**

Gently slide the DA-681A onto the rack, and then use the screws provided by the rack supplier to affix the computer to the rail, as shown in the pictures below.



**NOTE** four screws are required to attach the DA-681A to the rack. Use two screws on the left side and two screws on the right side.

As a final check, make sure that the four screws are firmly attached to the rack.



## Wiring Requirements

The following common safety precautions should be observed before installing any electronic device:

- Use separate paths to route wiring for power and devices. If power wiring and device wiring paths must cross, make sure the wires are perpendicular at the intersection point.
- You can use the type of signal transmitted through a wire to determine which wires should be kept separate. The rule of thumb is that wiring that shares similar electrical characteristics can be bundled together.
- Keep input wiring and output wiring separate.
- When necessary, it is strongly advised that you label wiring to all devices in the system.

 **ATTENTION** Do not run signal or communication wiring and power wiring in the same wire conduit. To avoid interference, wires with different signal characteristics should be routed separately.



**ATTENTION**

**Safety First!**

Be sure to disconnect the power cord before installing and/or wiring your device.

**Electrical Current Caution!**

Calculate the maximum possible current in each power wire and common wire. Observe all electrical codes dictating the maximum current allowable for each wire size.

If the current goes above the maximum ratings, the wiring could overheat, causing serious damage to your equipment.

**Temperature Caution!**

Be careful when handling the unit. When the unit is plugged in, the internal components generate heat, and consequently the outer casing may feel hot to the touch.

## Connecting the Power

The DA-681A offers both single power and dual power inputs. Use a screwdriver to remove the screws. Connect the power cord to the screws and then attach the screws to the unit. For single power models (SP), use Power 1 only; for dual power models (DPP and DPP-T), use both Power 1 and Power 2 for power input installation. Refer to the following figure for detailed information.

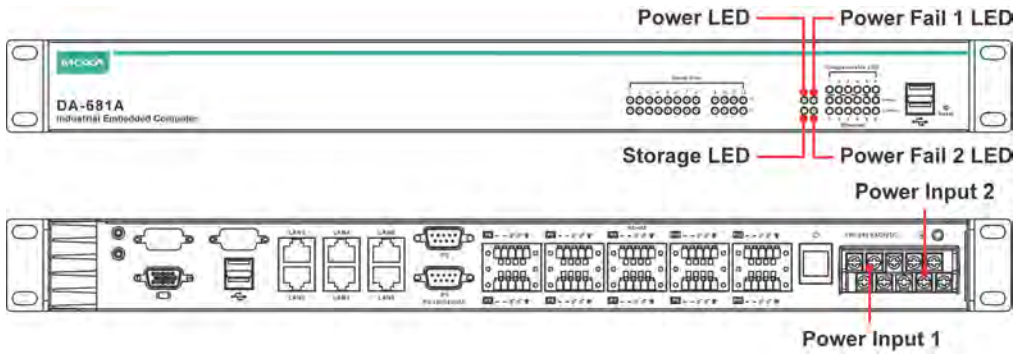

# Wiring the Power Inputs

## For SP Models

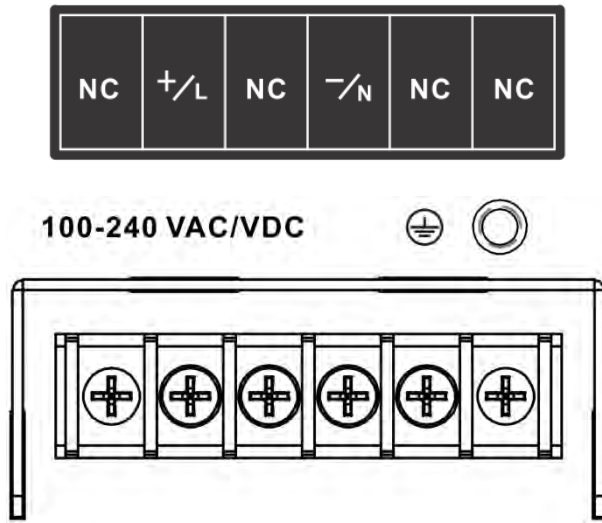

### AC Terminal

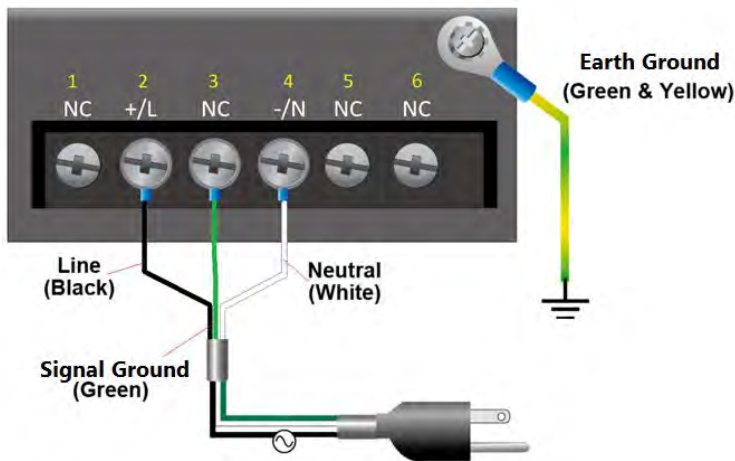

### DC Terminal

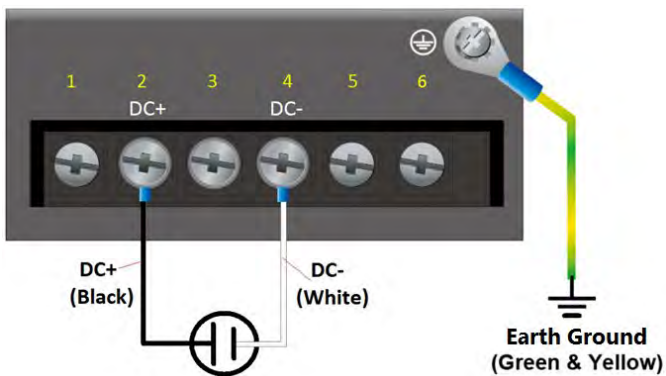



### For DPP and DPP-T Models

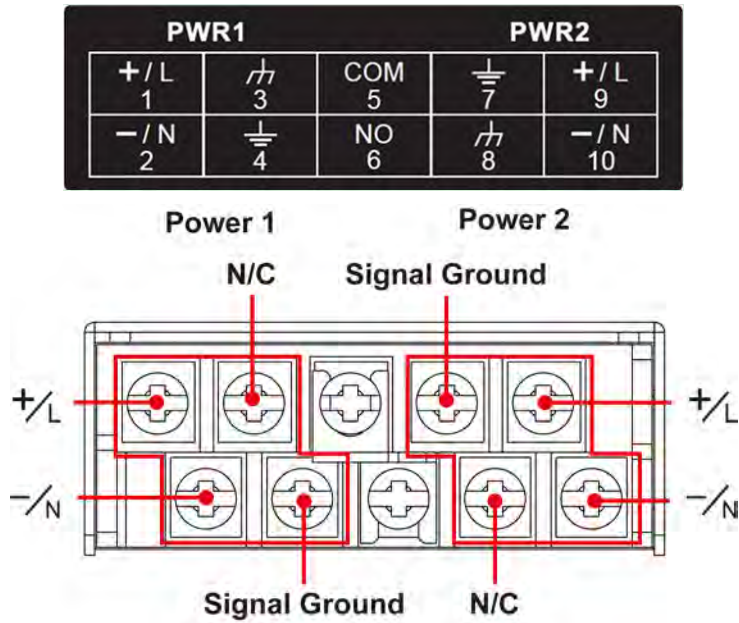

#### AC Terminal

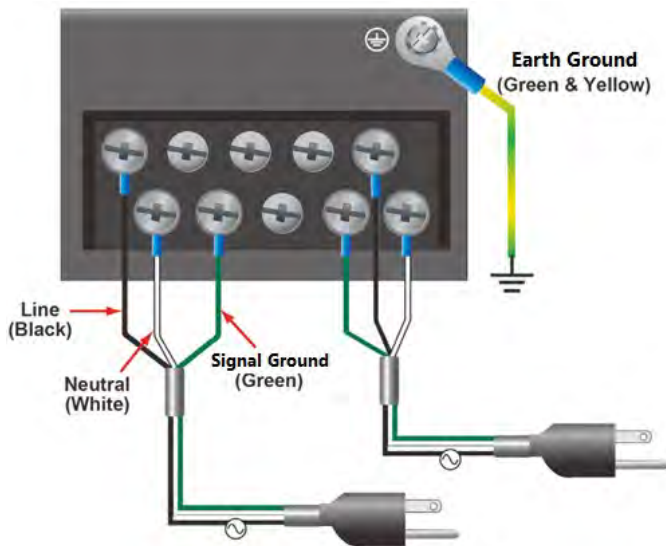

#### DC Terminal

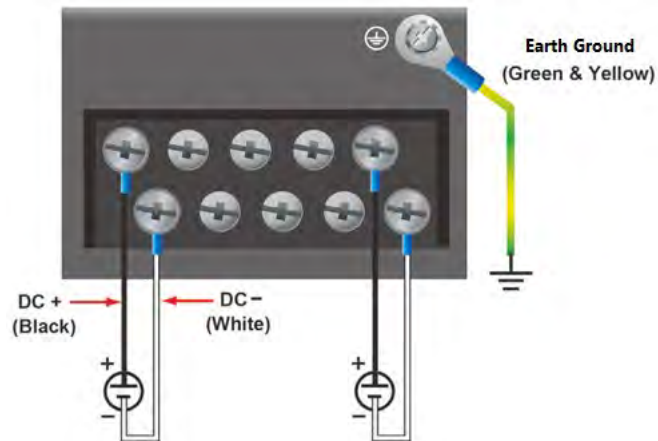

# Power Input Wiring Description

Read the following section for a detailed power input wiring description.

## SP Model power input wiring description



Terminal Number	Description	Note
1	N/C	No function
2	Line/DC+	Line/DC+ is connected to the positive (+) terminal if the power source is DC, or to the Line terminal if the power source is AC.
3	N/C	No function
4	Neutral/DC-	Neutral/DC- is connected to the negative (-) terminal if the power source is DC, or to the Neutral terminal if the power source is AC.
5	N/C	No function
6	N/C	No function

## DPP and DPP-T Model power input wiring description

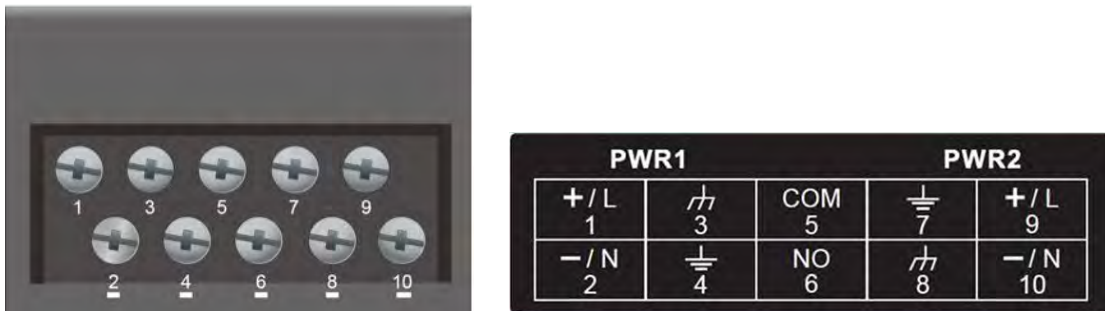

Terminal Number	Description	Note
1	PWR1 Line/DC+	<b>PWR1 Line/DC+</b> is connected to the positive (+) terminal if the power source is DC, or to the Line terminal if the power source is AC.
2	PWR1 Neutral/DC-	<b>PWR1 Neutral/DC-</b> is connected to the negative (-) terminal if the power source is DC, or to the Neutral terminal if the power source is AC.
3	NC	Reserved for future customization.
4	Signal Ground	<b>Signal Ground</b> is connected to the earth terminal for AC power source 1.
5	COM	COM pin of alarm relay
6	NO	Normal Open pin of alarm relay
7	Signal Ground	<b>Signal Ground</b> is connected to the earth terminal for AC power source 1.
8	NC	Reserved for future customization.
9	PWR2 Line/DC+	<b>PWR2 Line/DC+</b> is connected to the positive (+) terminal if the power source is DC, or to the Line terminal if the power source is AC.
10	PWR2 Neutral/DC-	<b>PWR2 Neutral/DC-</b> is connected to the negative (-) terminal if the power source is DC, or to the Neutral terminal if the power source is AC.

# Reset Button

Pressing the Reset button initiates a hardware warm reboot. The button plays the same role as a desktop PC’s reset button. After pressing the reset button, the system will reboot automatically. During normal use, you should NOT use the Reset Button. You should only use this button if the software is not working properly. To protect the integrity of data being transmitted or processed, you should always reset the system from the operating system with the software reboot function.



# Front Panel LED

There are 46 LED indicators on the front panel. Information about each LED is given in the following table.

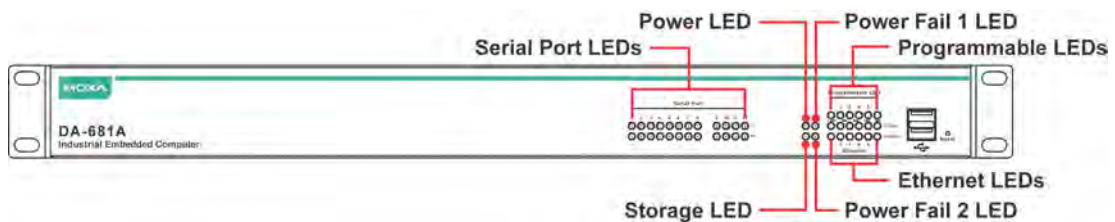

LED	Color	Description
Serial Port TX 1-12	Green	Serial port is transmitting data
	Off	Not operating
Serial Port RX 1-12	Yellow	Serial port is receiving data
	Off	Not operating
Power	Green	Power is on
	Off	No power input or power error exists
Storage	Yellow/Blinking	Data is being written to or read from the storage unit
	Off	Storage unit is idle
Power Fail 1	Red	Power 1 has failed (for dual power models only)
	Off	Power is being properly supplied
Power Fail 2	Red	Power 2 has failed (for dual power models only)
	Off	Power is being properly supplied
Gigabit LAN LEDs 1-6	Green	100 Mbps Ethernet mode
	Yellow	1000 Mbps (Gigabit) Ethernet mode
	Off	Not operating, or in 10 Mbps Ethernet mode
Programmable 1-6	Green	Defined by user

# Connecting to a Display

Your DA-681A embedded computer comes with a D-Sub 15-pin female connector to connect to the VGA monitor. Be sure to remove the power before you connect or disconnect the monitor cable.

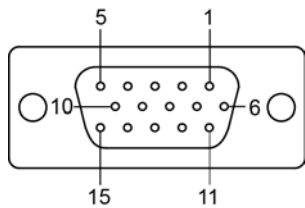
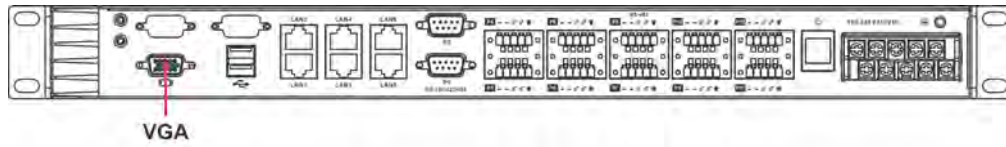

Pin No.	Signal Definition
1	RED
2	GREEN
3	BLUE
4	—
5	GND
6	CRT_DETECT#
7	GND
8	GND
9	+5V
10	GND
11	—
12	DDC_DATA
13	HSYNC
14	VSYSNC
15	—

# Connecting USB Devices

The DA-681A embedded computer has four USB 2.0 ports, two on the rear panel and two on the front panel. All of the ports are UHCI, Rev 2.0 compliant and support Plug & Play and hot swapping. These ports can be used to connect USB devices, such as a keyboard, mouse, USB flash disk, and USB CD-ROM. In addition, both USB ports support system boot up, which can be activated by modifying the BIOS settings. The chapter “BIOS Setup” describes the configuration process in detail.

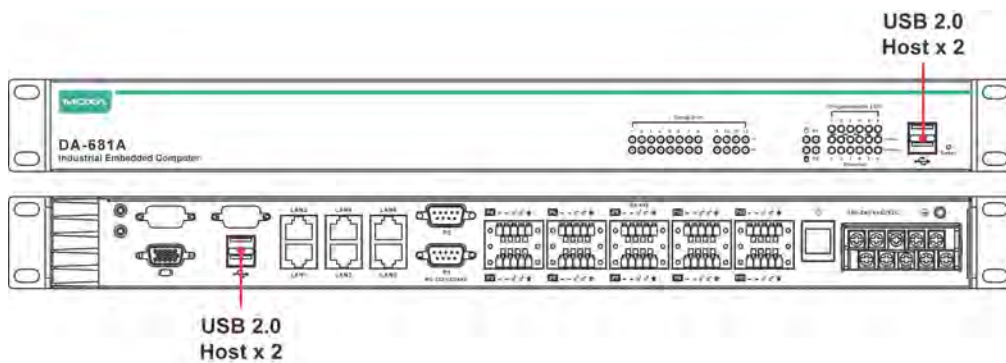

# Connecting a Serial Device

The DA-681A has two 3-in-1 RS/232/422/485 serial ports, and 10 RS-485 ports. When the cable is properly connected, the LEDs on the front panel will glow to indicate a proper connection.

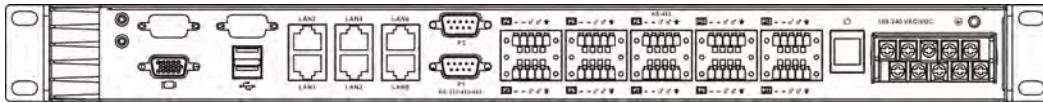

**DB9 Pin Assignment**

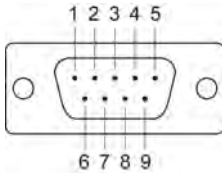

Pin	RS-232	RS-485 (4W)	RS-485 (2W)	RS-422
1	DCD	TxD-(A)	-	TxD-(A)
2	RXD	TxD+(B)	-	TxD+(B)
3	TXD	RxD+(B)	Data+ (B)	RxD+(B)
4	DTR	RxD-(A)	Data-(A)	RxD-(A)
5	GND	GND	GND	GND
6	DSR	-	-	-
7	RTS	-	-	-
8	CTS	-	-	-
9	-	-	-	-

**Terminal Block Pin Assignment**

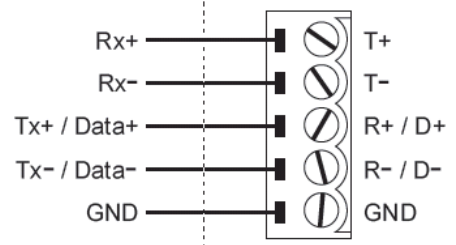

LED	Color	Description
Serial Port TX 1-12	Green	Serial port is transmitting data
	Off	No operation
Serial Port RX 1-12	Yellow	Serial port is Receiving data
	Off	No operation

# LAN Ports

The DA-681A has 6 10/100/1000 Mbps LAN ports. The pin assignments are shown below.

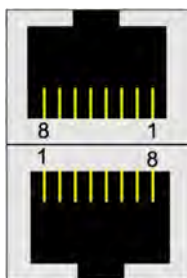
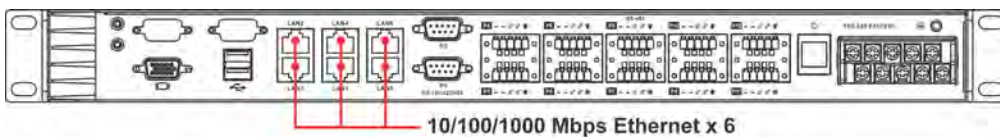

Pin No.	10/100 Mbps	1000 Mbps
1	TX+	TRD(0)+
2	TX-	TRD(0)-
3	RX+	TRD(1)+
4	-	TRD(2)+
5	-	TRD(2)-
6	RX-	TRD(1)-
7	-	TRD(3)+
8	-	TRD(3)-

The default IP addresses and netmasks of the Gigabit LAN ports are as follows:

	Default IP Address	Netmask
LAN 1	192.168.3.127	255.255.255.0
LAN 2	192.168.4.127	255.255.255.0
LAN 3	192.168.5.127	255.255.255.0
LAN 4	192.168.6.127	255.255.255.0
LAN 5	192.168.7.127	255.255.255.0
LAN 6	192.168.8.127	255.255.255.0

## Connecting the IRIG-B time synchronization device (For DPP & DPP-T models only)

DA-681A-DPP and DA-681A-DPP-T models are equipped with 1 PCI-104 socket for adding the DA-IRIGB-4DIO-PCI104-EMC4 expansion module (optional) for time synchronization applications.

	Model	Description
	DA-IRIGB-4DIO-PCI104-EMC4	Time synchronization expansion module with 1 IRIG-B signal input port, 3 digital inputs, 4 digital outputs (DA-681A-I-DPP series only)

## DA-IRIGB-4DIO-PCI104-EMC4 Pin Assignments

Pin assignments for the male DB9 connectors for connecting an IRIG-B signal source, or digital input (DI) or digital output (DO) device.

### IRIG-B signal input

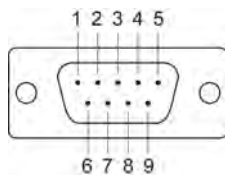

Pin	Differential	TTL
1	-	-
2	-	-
3	Data +	TTL
4	Data -	GND
5	-	-
6	-	-
7	-	-
8	-	-
9	-	-

### Digital Input / Digital Output

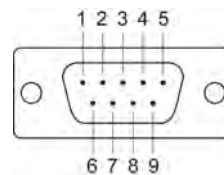

Pin	3DIs, 4DOs
1	DO 0
2	DO 1
3	DO 2
4	DO 3
5	DO COM
6	DI 0
7	DI 1
8	DI 2
9	DI Source

# Connecting to the DA-IRIGB-B-S Series



**ATTENTION**

To prevent damage to your system or the mother board, make sure that you turn off the embedded computer before installing the DA-IRIGB-B-S Series module.

1. Turn the embedded computer off.
2. Remove the four screws for the PCI-104 socket.
3. Install the four spacers on the embedded computer.



4. Insert the DA-IRIGB-4DIO-PCI104-EMC4 module firmly into an available PCI/104 slot and tighten the screws.

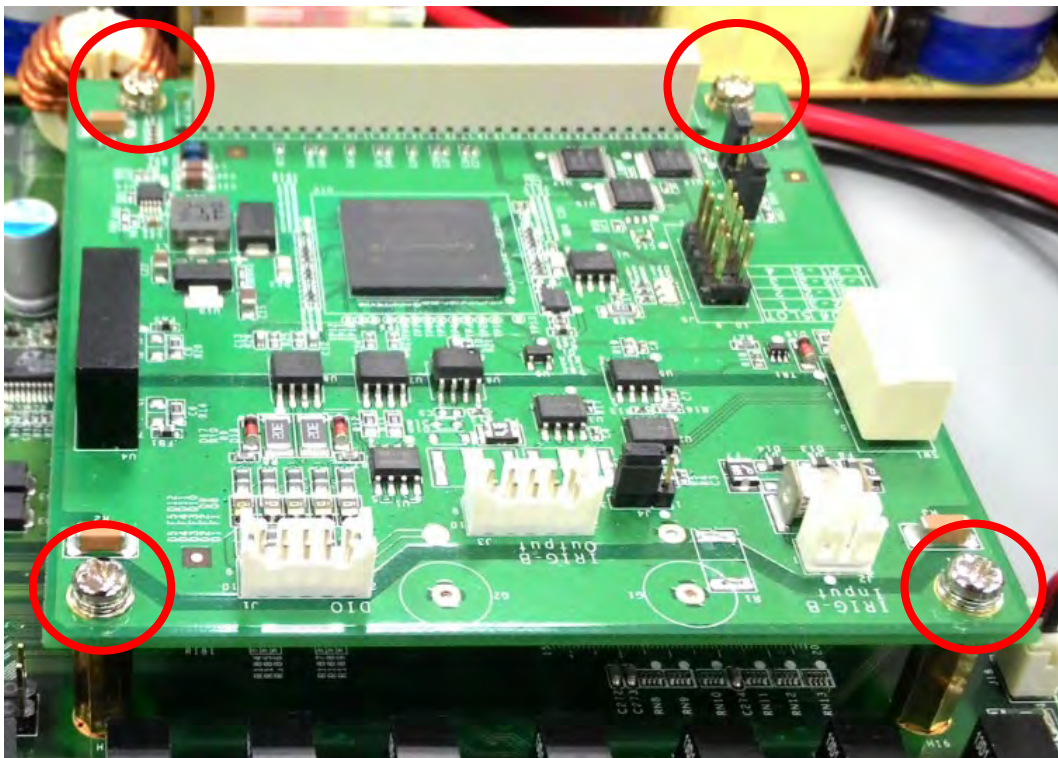

- 5. Connect the cables by completing the following actions:
  - a. Connect the 2-wire IRIG-B input signal cable.
  - b. Connect the 4-wire IRIG-B output signal cable.
  - c. Install the DB9 connectors on the rear panel of the embedded computer.
  - d. Connect the 2-wire IRIG-B input signal cable.

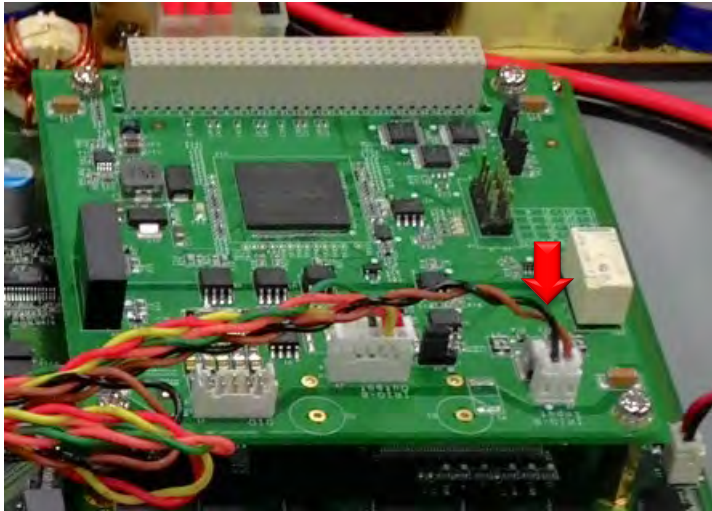

- e. Connect the 4-wire IRIG-B output signal cable.

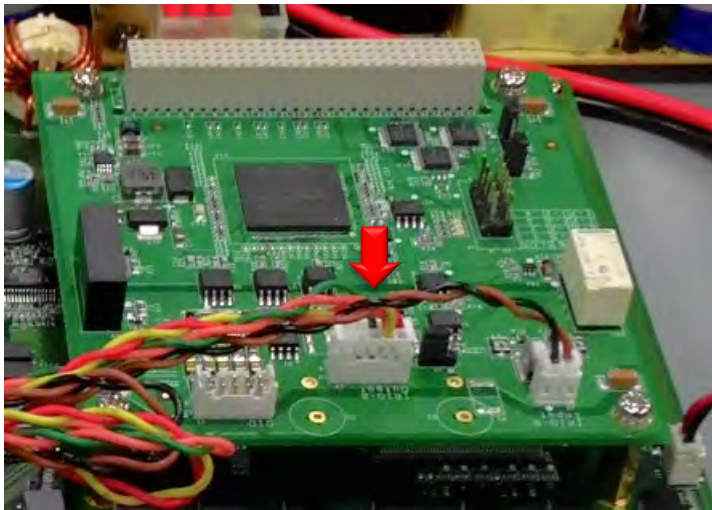

- f. Install the DB9 connector on the rear panel of the DA-681A.

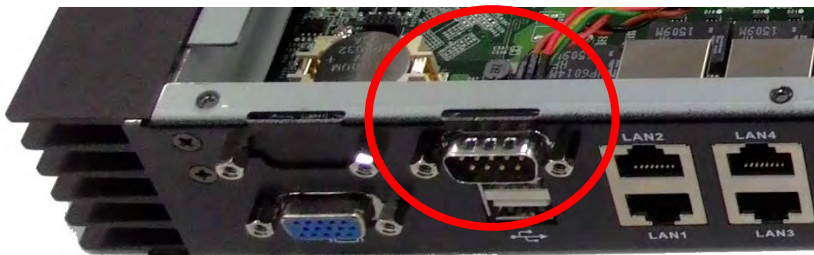

- 6. Turn on the embedded computer. The BIOS will automatically set the IRQ and I/O address.



# Installing the Memory Module

The DA-681A embedded computer supports one DDR3-1066/1333 SO-DIMM module with up to 8 GB. One 2 GB DDR3 SDRAM memory module is pre-installed for Linux models. An SDRAM module is not included with the DA-681A-SP, DA-681A-DPP, and DA-681A-DPP-T barebones models. To install the DDR3 SDRAM memory module, follow these instructions:

1. Disconnect the DA-681A from the power source.
2. The DA-681A's memory module is located inside the DA-681A. Use a screwdriver to remove the screws on the top cover of the DA-681A.
3. After removing the memory module cover, you will see the DDR3 SDRAM Socket.

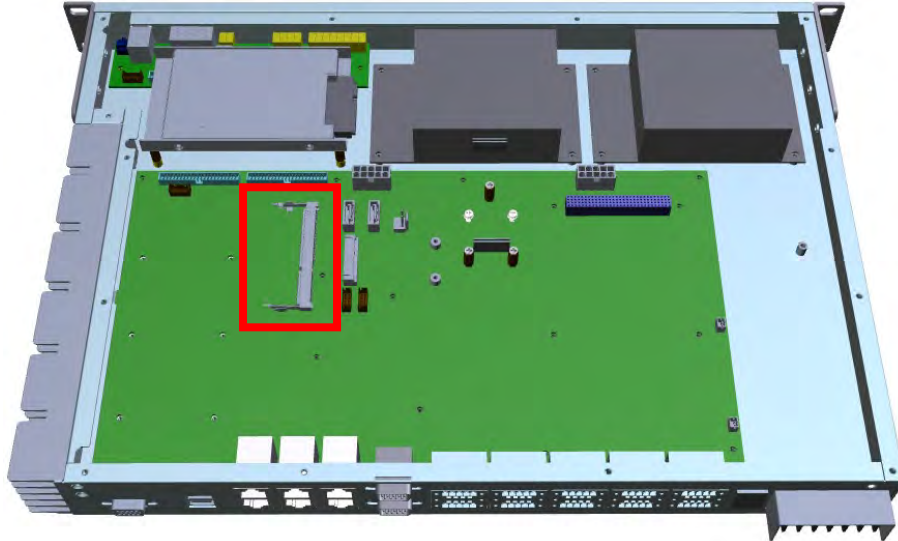

Gently insert the new memory into the module. Make sure the direction is correct.



Push the memory all the way down to complete.



# Installing a mSATA Card

The DA-681A embedded computer comes with a mSATA socket. To insert a mSATA card, follow these instructions.

1. Disconnect the DA-681A from its power source.
2. The DA-681A's mSATA socket is located inside the DA-681A. Use a screwdriver to remove all the screws on the top cover of the DA-681A.
3. Insert the mSATA card into the socket. Push downwards to make sure that the card is firmly inserted, and then tighten the screws.

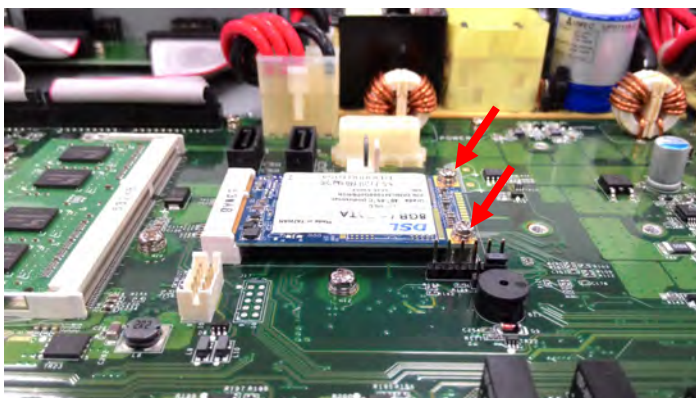

## ATTENTION

The DA-681A embedded computer does not support the mSATA hot swap and PnP (Plug and Play) functions. It is necessary to remove power source first before inserting or removing the mSATA card.

## Installing a SATA Hard Disk / Solid State Disk

The DA-681A embedded computer has one SATA connector for installing a SATA hard disk / Solid State Disk. To install a 2.5-inch SATA hard disk / Solid State Disk, follow these instructions. (The hard disk bracket is an optional accessory that can be purchased separately.)

1. Disconnect the DA-681A from its power source.
2. Open the top cover of the DA-681A.
3. The hard disk bracket should be installed on the top left side of the DA-681A.



4. Remove the screws for the LED board.



5. Install the four spacers on the embedded computer.

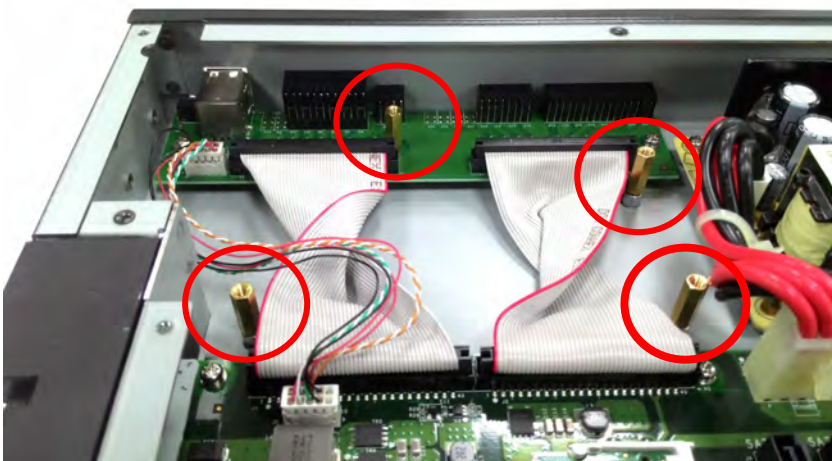

6. Install the SATA hard disk / Solid State Disk in the hard disk bracket.



7. Connect the SATA cable and power cable to the hard disk / Solid State Disk.



8. Next, install the SATA hard disk / Solid State Disk and bracket in the DA-681A. Make sure the screws are firmly attached.

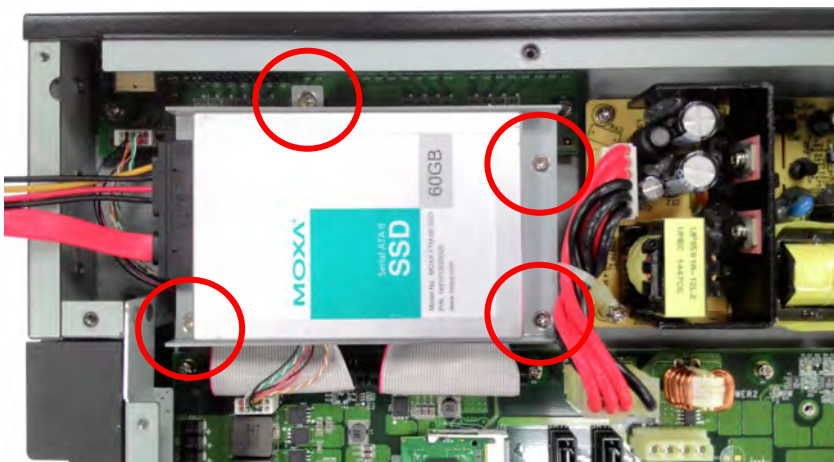

- 9. Connect the SATA power cable to the computer.

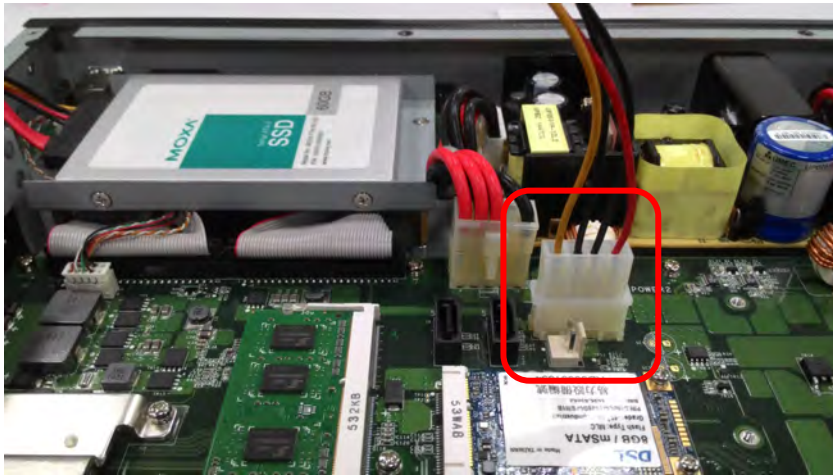

- 10. Connect the SATA HDD/SSD signal cable to the computer.

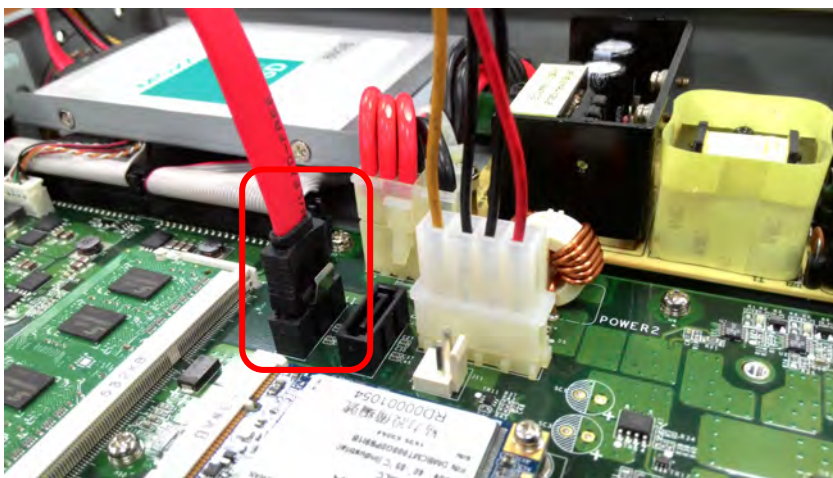

- 11. Properly position the cables, as shown in the following figure.



**ATTENTION**

The SATA hard disk kit and cables are not included in the basic shipment of the DA-681A embedded computer. Any standard SATA disk cable and power cable can be used.

## Installing a USB Dongle Kit

An optional USB Dongle Kit can be purchased separately for the DA-681A embedded computer for installing a USB Dongle tightly inside the computer. To install the USB dongle with the USB Dongle Kit, follow these instructions. (The USB Dongle Kit is an optional accessory that can be purchased separately.)

1. Disconnect the DA-681A from its power source.
2. Open the top cover of the DA-681A.
3. The USB Dongle Kit should be installed in the middle of the DA-681A and close to the mSATA.

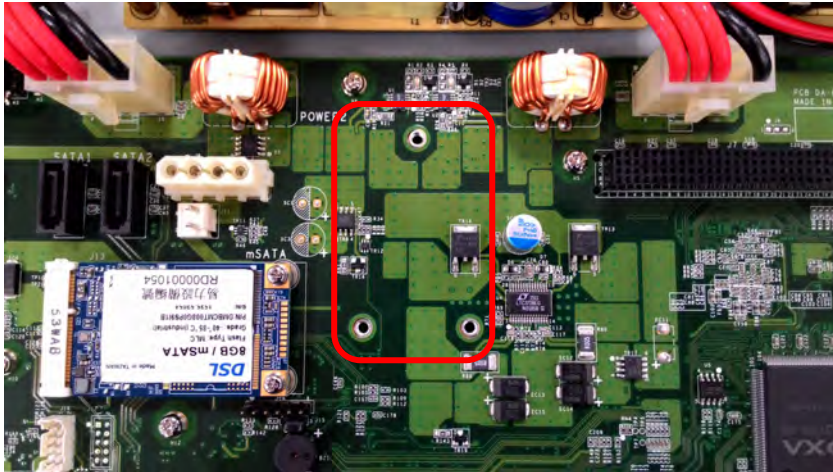

4. Install the three spacers on the embedded computer.

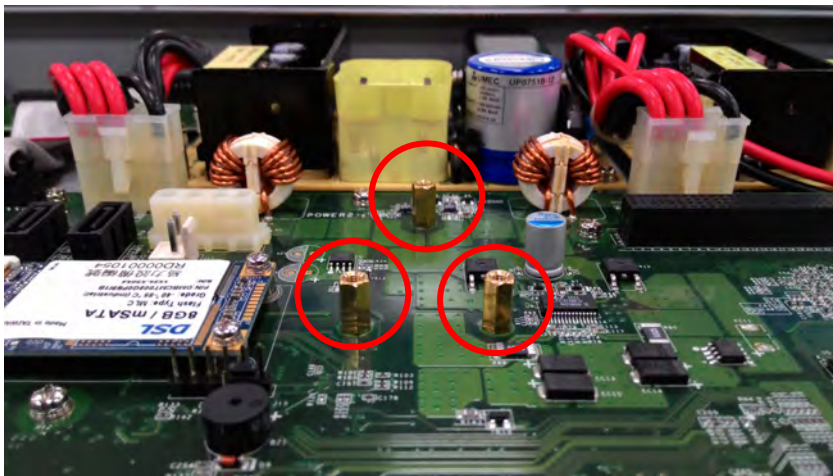

5. Connect the USB Cable to the dongle bracket.



6. Install the USB Dongle Kit in the DA-681A. Make sure the screws are firmly attached and connect the USB cable to computer.

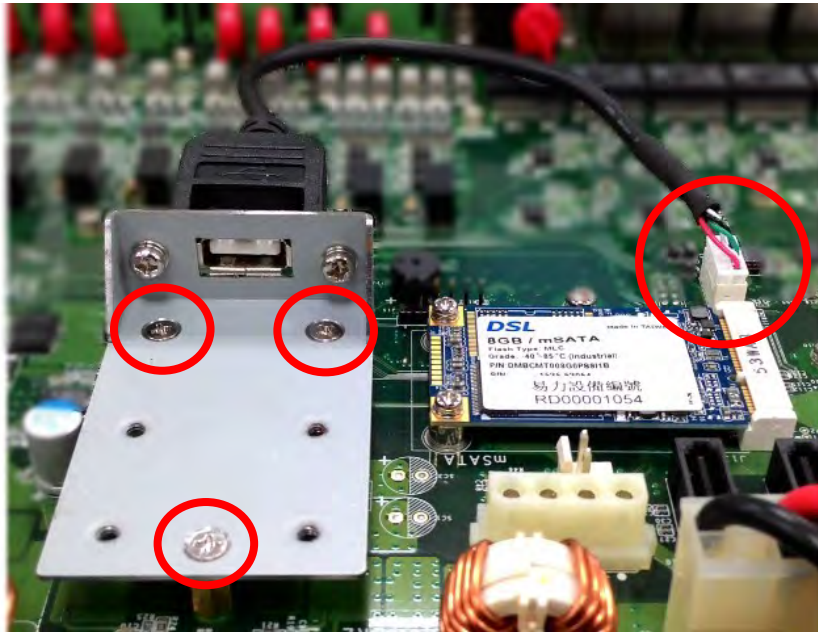

7. Install the USB Dongle in the Dongle bracket.

Mini sized dongle	Normal sized dongle

## BIOS Setup

---

This chapter describes the BIOS settings of the DA-681A embedded computers. The BIOS is a set of input/output control routines for peripherals. The BIOS is used to initialize basic peripherals and helps boot the operating system before the operating system is loaded. The BIOS setup allows the user to modify the system configurations of these basic input/output peripherals. All of the configurations will be stored in the battery backed up CMOS RAM, which retains the system information after system reboots or the power is removed.

The following topics are covered in this chapter:

### ❑ Entering the BIOS Setup

#### ❑ Main Information

#### ❑ Advanced Settings

- Boot Configuration
- HDC Configuration
- Video Configuration
- Chipset Configuration
- Hardware Monitor

#### ❑ Security Settings

- Set Supervisor Password

#### ❑ Power Settings

- Auto Wake on S5
- Wake on LAN

#### ❑ Boot Settings

- Boot Type
- PXE Boot to LAN
- Add Boot Options
- USB Boot
- EFI Device First
- Boot Delay Time
- Legacy

#### ❑ Exit Settings

- Exit Saving Changes
- Save Change Without Exit
- Exit Discarding Changes
- Load Optimal Defaults
- Load Custom Defaults
- Save Custom Defaults
- Discard Changes

#### ❑ Upgrading the BIOS



# Entering the BIOS Setup

To enter the BIOS setup utility, press the "F2" key while the system is booting up. The main **BIOS Setup** screen will appear. Four options will be available:

**Continue:** Continue to boot up

**Boot Manager:** Select the device for booting up

**Boot From File:** Select the UEFI boot up fil

**SCU:** Enter the BIOS configuration step.

Select **SCU** to enter the **BIOS configuration**.



When you enter SCU, a basic description of each function key is listed at the bottom of the screen. Refer to these descriptions to learn how to use them.

<b>F1</b>	<b>General Help</b>	<b>↑ ↓ .</b>	<b>Select Item</b>
<b>F5/ F6</b>	<b>Change Values</b>	<b>← →</b>	<b>Select Menu</b>
<b>F9</b>	<b>Setup Defaults</b>	<b>ESC</b>	<b>Exit</b>
<b>F10</b>	<b>Save and Exit</b>	<b>ENTER</b>	<b>Select or go to Submenu.</b>

The BIOS configuration screen will be shown when you enter SCU option. Refer to the following figure.

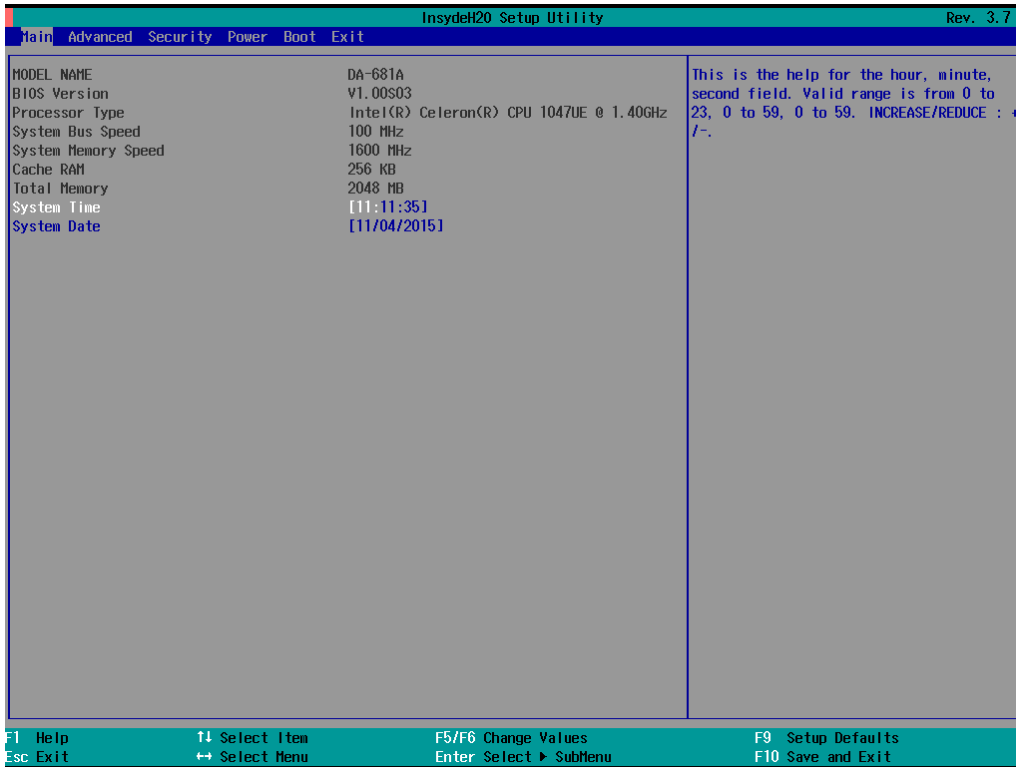

Please note that the information for Processor Type will vary depending on the different models that you purchase.

## Main Information

The main page indicates the system information, such as model name, BIOS version, and CPU type. User may view the basic system hardware information in the page.

## Advanced Settings

The “Advanced Features” screen will appear when choosing the “Advanced” item from the main menu.

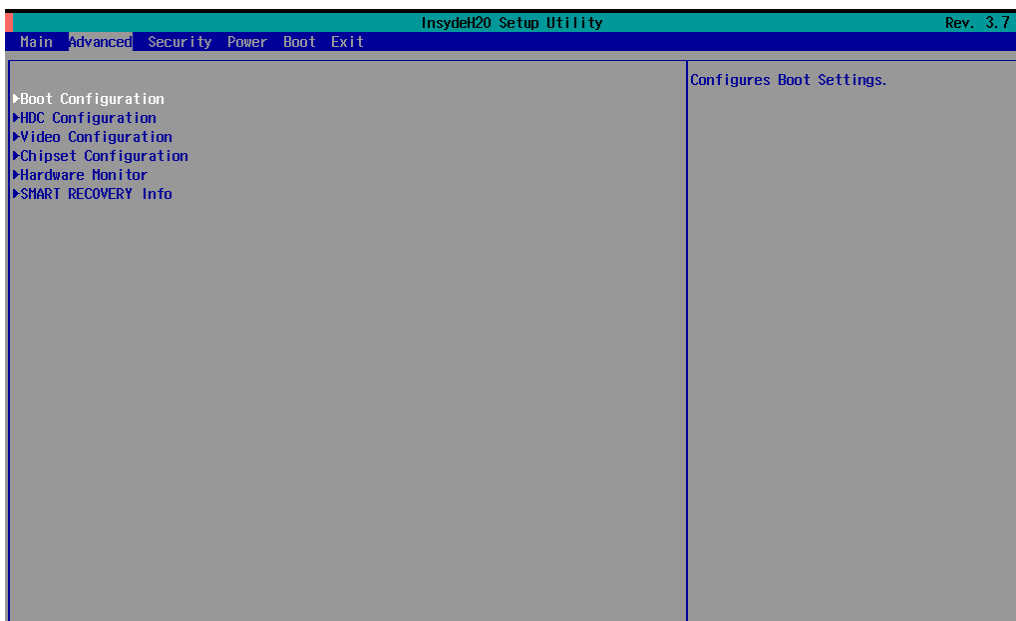

## Boot Configuration

This item allows users to configure the default value of Numlock.

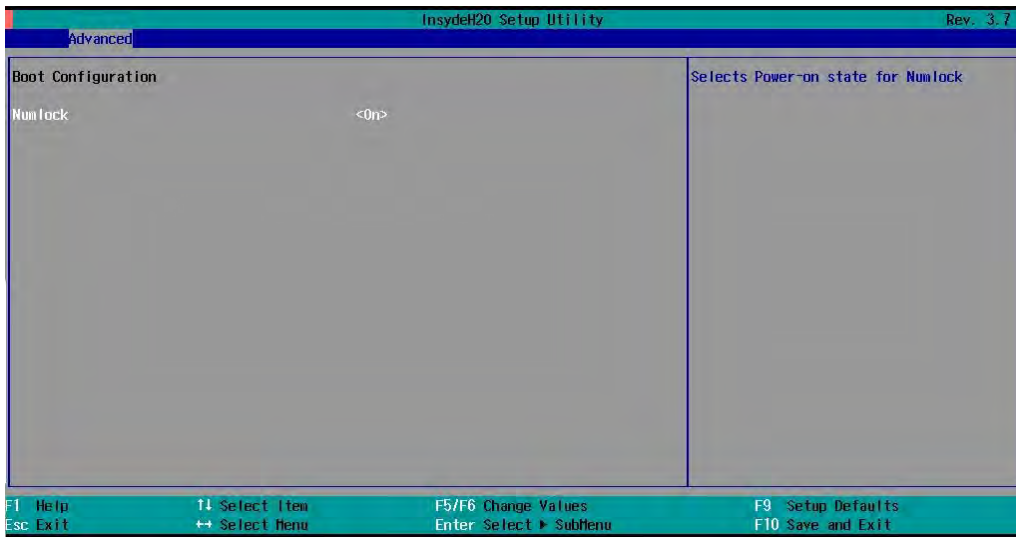

Option: On (default), Off.

## HDC Configuration

The host drive controller may be configured for IDE (legacy default) or AHCI mode. When the legacy IDE mode is selected, the following screen will appear.

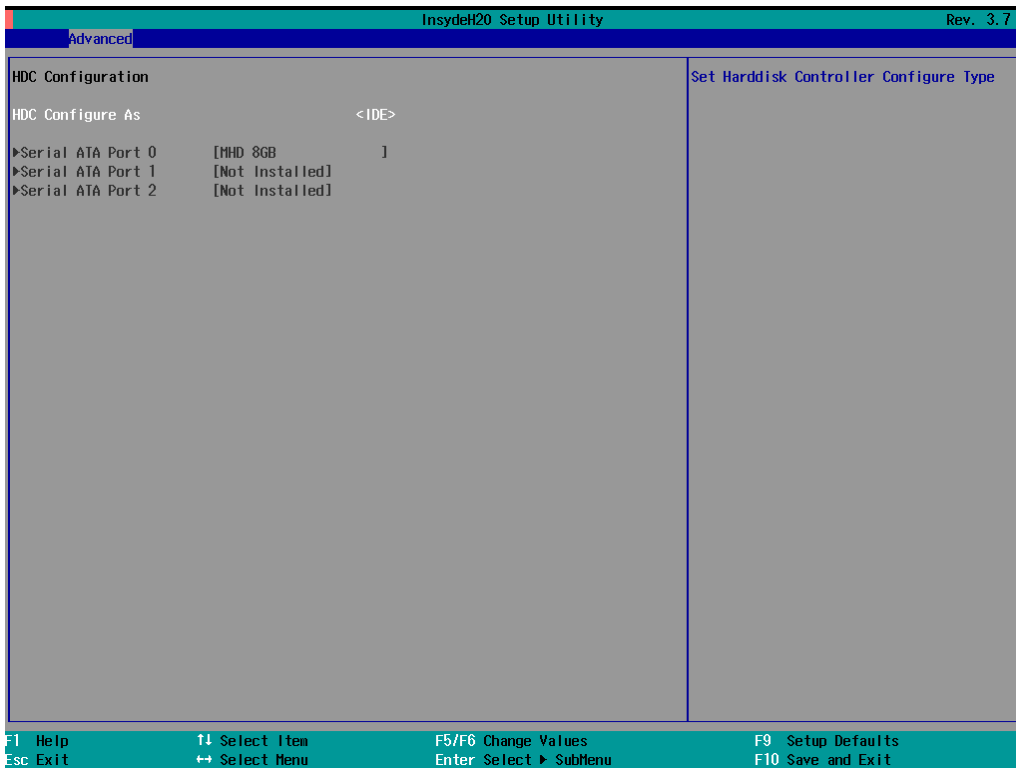

## Serial ATA Port 0 to 2

This setting allows the user to display information about the installed drives.

### AHCI SALP

Please note that AHCI SALP will only appear when AHCI mode is selected. This item allows you to enable aggressive **link power management** (SALP) in AHCI. SALP enables the host bus adapter to conserve power by directly detecting when a SATA drive is no longer processing information and then immediately shifting it into suspended or sleep modes without waiting for software processes to initiate power-down processes.

Options: Enabled (default), Disabled

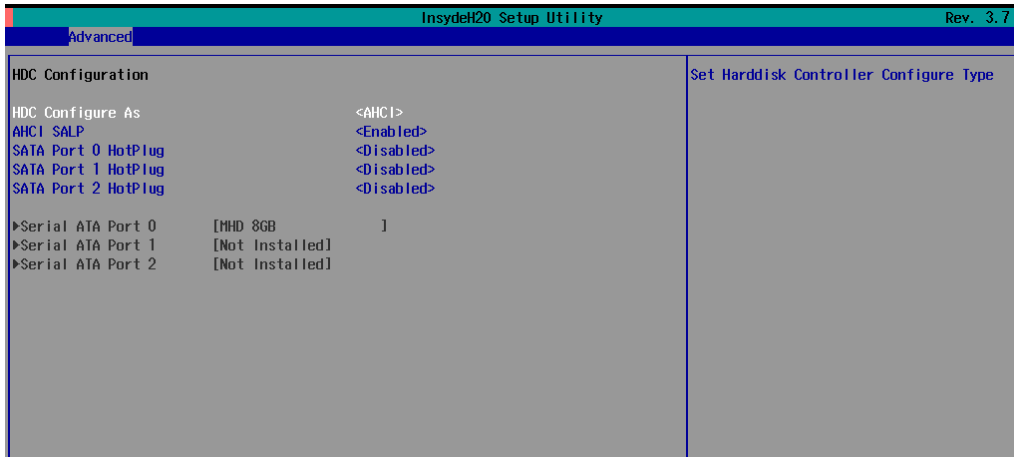

### SATA Port 0 to 2 - HotPlug

This item allows you to enable/disable hotplug capabilities (the ability to remove the drive while the computer is running) for installed storage drives.

Options: Disable (default), Enabled

## Video Configuration

This item allows you to configure the integrated graphics device (IGD) for things like memory allocation (DVMT)

### Internal Graphics Device

This option allows you to enable/disable the internal graphics device.

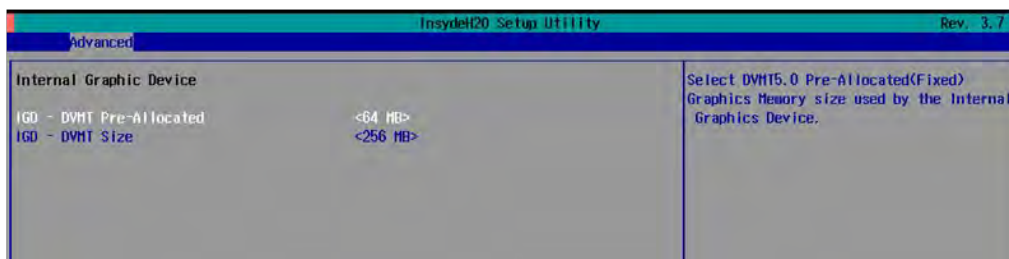

### IGD—DVMT Pre-Allocated

This item allows you to configure pre-allocated memory capacity for the IGD. Pre-allocated graphics memory is invisible to the operating system.

Options: 64 MB (default), 32 MB, 96 MB, 128 MB, 256 MB, 512 MB

**DVMT** is a BIOS solution where “the optimum amount of memory is dynamically allocated and de-allocated as needed for balanced graphics and system performance, through Intel® Direct AGP and a highly efficient memory utilization scheme. DVMT ensures the most efficient use of available system memory resources for maximum 2D/3D graphics performance.

### IGD—DVMT Size

This item allows you to configure the maximum amount of memory DVMT will use when allocating additional memory for the internal graphics device.

Options: 256 MB (default), 128 MB, Max

## Chipset Configuration

This item allows you to configure the chipset settings.

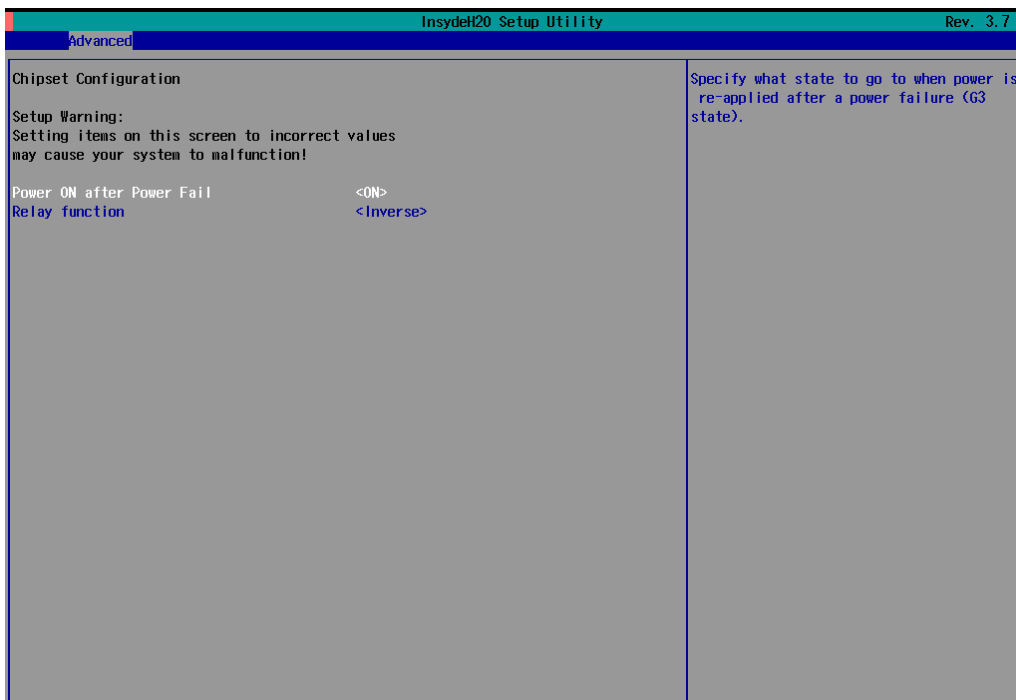

### Power ON after Power Fail

This item allows you to enable/disable the computer from automatically powering up after a system crash.

Options: ON (default), OFF, Last State

### Relay Function

This item is related to protecting the board’s Normal-Close/Normal-Open setting; the default is the inverse of indicating power on/power off.

Options: Inverse (default), Normal

## Hardware Monitor

This item allows you to view stats like CPU and system temperature, voltage levels, and other chipset information.

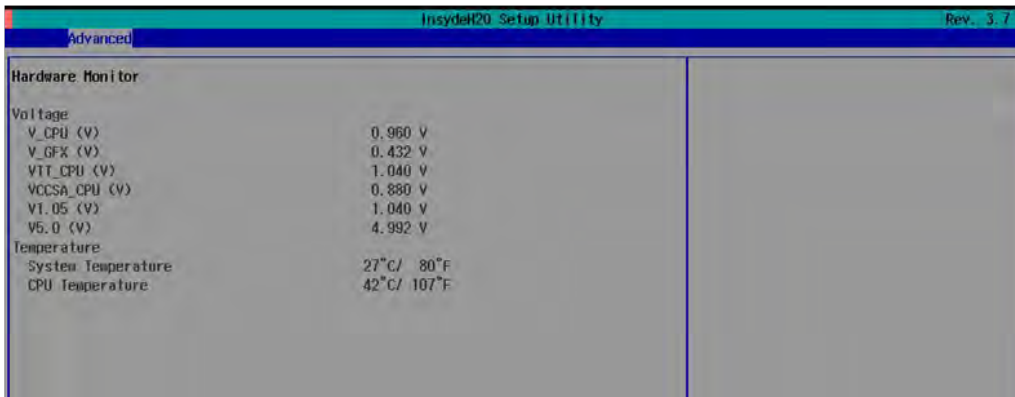

Please note that the voltage values will vary depending on the different models, and there will be 5% tolerance for the temperature values. Please also note that at 100°C the accuracy of CPU temperature readings are in the range of -5°C to +10°C. This deteriorates to -10°C to +15°C at 50°C. The CPU temperature readings saturates at one point below 50°C. Any CPU reading below 50°C is unreliable, and may only be interpreted as indicating a temperature below 50°C. For system temperature, there will be 5% tolerance for the temperature values.

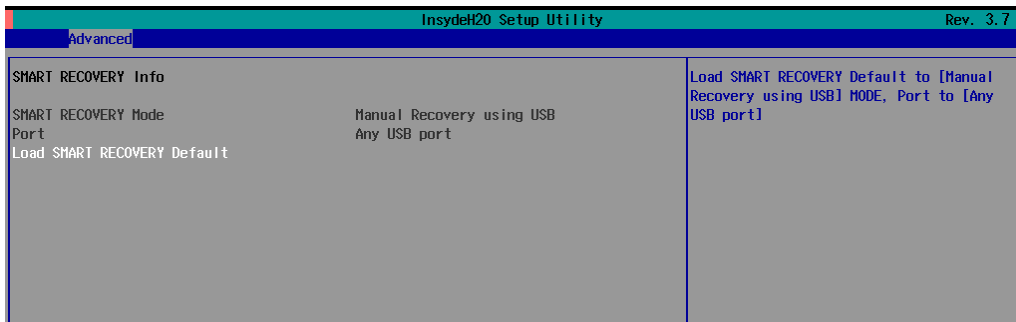

This page indicates that the system supports smart recovery. Additional information is available on Moxa's website at: <http://www.moxa.com/product/Smart-Recovery.htm>.

## Security Settings

This section allows users to configure security settings with a supervisor password and user password.

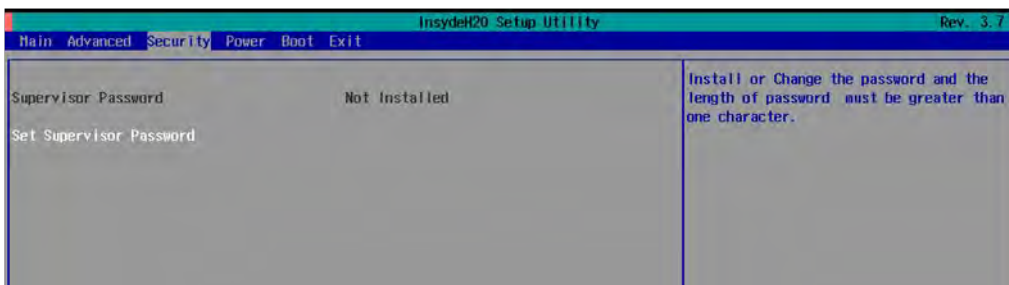

## Set Supervisor Password

This item allows you set the supervisor password. Select and then enter the password, and then confirm the password again.

To delete the password, enter **Set Supervisor Password** and then enter the old password; then, leave the new password fields blank, and press enter.

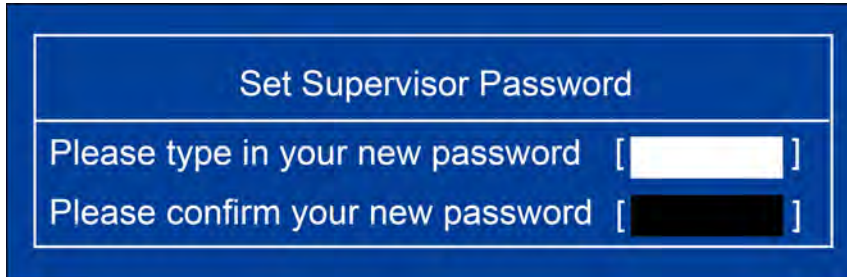

## Power Settings

The section allows users to configure power settings.

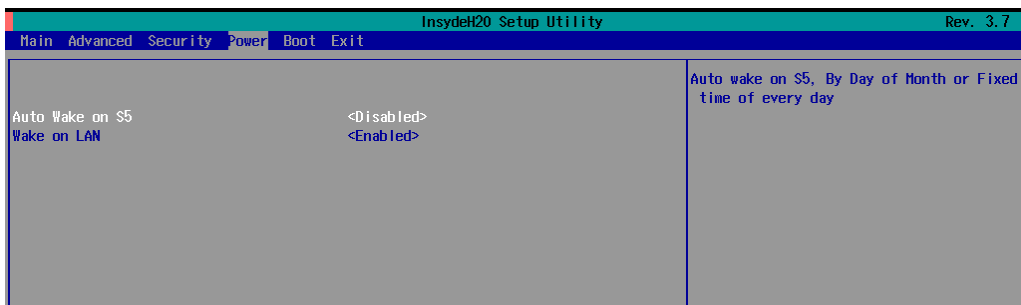

### Auto Wake on S5

This item allows you to configure the computer to wake from S5 status. S5 stands for Soft Off, where the PSU remains engaged but power to all other parts of the system is cut. Auto-wake on S5 schedules a soft-reboot at certain periodic times that may be specified in the BIOS.

Options: Disabled (default); By Every Day (user specifies a regular daily time when the computer will power up); By Day of Month (user specified a regular day each month when the computer will power up)

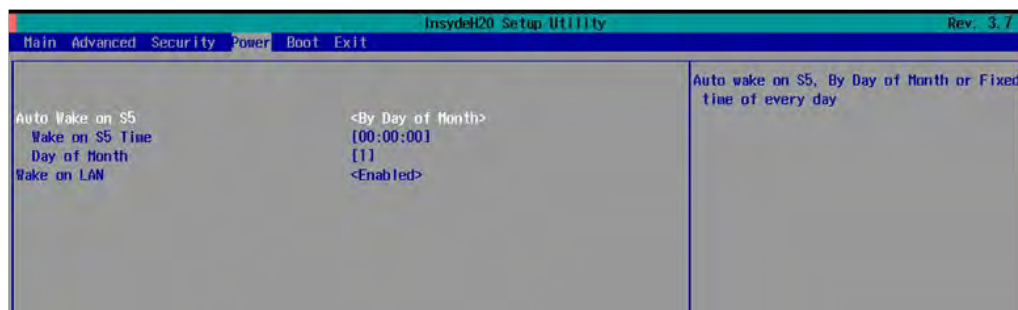

### Wake on LAN

This feature is used to wake on the system by a LAN device from a remote host.

Options: Enabled (default), Disable.

# Boot Settings

The section allows users to configure boot settings.

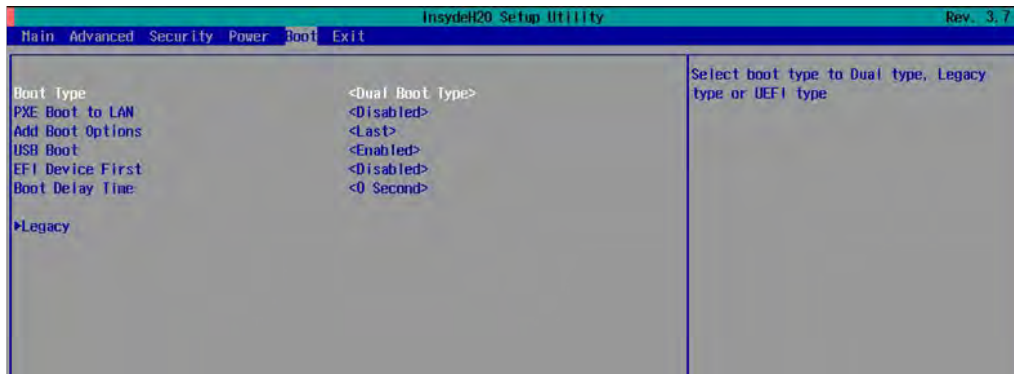

## Boot Type

This item allows you to enable/disable quick boot function.

Options: Dual Boot Type (default), Legacy Boot Type, UEFI Boot Type.

## PXE Boot to LAN

This item allows you to enable/disable PXE boot to LAN function.

Options: Disabled (default), Enabled

## Add Boot Options

This item allows you to add the boot order options for shell, network and Removables.

Options: Last (default), First

## USB Boot

This item allows you to enable/disable USB boot function..

Options: Enabled (default), Disabled

## EFI Device First

This item allows you to determine EFI device first or legacy device first. If enabled, EFI device will be the first; if disabled, legacy device will be the first.

Options: Disabled (default), Enabled

## Boot Delay Time

This item allows you to configure the delay time value for users to input hot key during POST time.

Options: 0 Second (default), 3 Seconds, 5 Seconds, 10 Seconds



## Legacy

### Normal Boot Menu

This item allows you to configure the boot menu.

Options: Normal (default), Advance

### Boot Type Order

This item allows you to select the boot order. Use +/F5 (move up) or -/F6 (move down) to change values.

Options: Hard Disk Drive (default), CD/DVD-ROM Drive, USB, Others

### Hard Disk Drive/USB Drive

This item allows you to view installed devices such as hard disk drives, USB drives, or CD-ROMs. For example, if you have inserted a USB drive into the computer, it will appear here.

## Exit Settings

The section allows users to exit the BIOS environment.

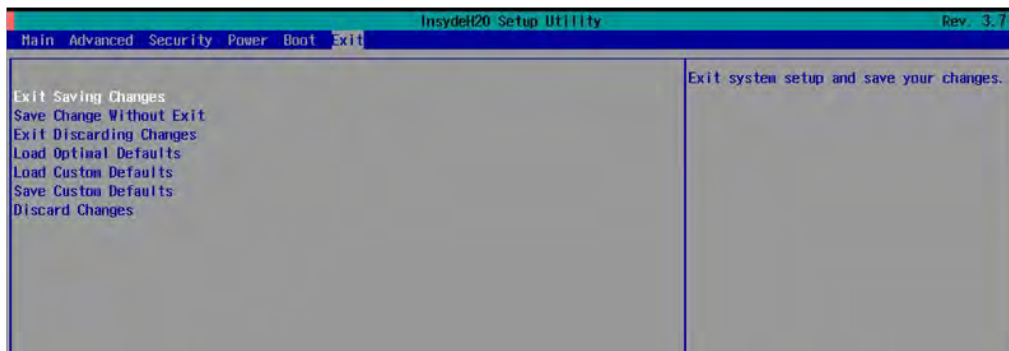

### Exit Saving Changes

This item allows you to exit the BIOS environment and save the values you have just configured.

Options: Yes (default), No

### Save Change Without Exit

This item allows you to save changes without exiting the BIOS environment.

Options: Yes (default), No

### Exit Discarding Changes

This item allows you to exit without saving any changes that might have been made to the BIOS.

Options: Yes (default), No

## Load Optimal Defaults

This item allows you to revert to the factory default BIOS values.

Options: Yes (default), No

## Load Custom Defaults

This item allows you to load custom default values for the BIOS settings.

Options: Yes (default), No

## Save Custom Defaults

This item allows you to save the current BIOS values as a “custom default” that may be reverted to at any time by the “load custom defaults” selection just above.

Options: Yes (default), No

## Discard Changes

This item allows you to discard all settings you have just configured.

Options: Yes (default), No

## Upgrading the BIOS

This section describes how to upgrade the BIOS. However, please note that it is easy to permanently damage the computer when upgrading the BIOS. We strongly recommend that you contact Moxa’s technical support staff for assistance in order to obtain all necessary tools and the most current advice before attempting to upgrade the BIOS on any Moxa device.

### **Step 1: Create a Bootable USB Disk**

Before upgrading the BIOS every user should first create a bootable USB RAM drive as a system rescue device. A useful software suite for building USB RAM drives can be found by searching for Rufus, which can then be downloaded and used to create a bootable RAM drive. Take the following steps to create a bootable USB disk by using Rufus.

1. Start Rufus and select the USB device that you want to use as a bootable disk from the Device drop-down list.
2. Select **MBR partition scheme for BIOS or UEFI computers** to boot from a legacy BIOS or UEFI.
3. Select **FAT (Default)** from File system drop-down list.
4. Select **16 kilobytes (Default)** for Cluster size.
5. Enter a drive name under **New volume label**.
6. Check **Quick format**, **Create a bootable disk using FreeDOS**, and **Create extended label and icon files**.
7. Click **Start** to format and create the bootable USB drive.



**ATTENTION**

We suggest you use a USB drive with under 2 GB in disk space, as larger USB drives may not support FAT file format and consequently fail to boot.

**Step 2: Prepare the Upgrade File**

You must use the BIOS upgrade installation file to upgrade the BIOS. Contact Moxa's technical department for assistance.

1. Get the BIOS upgrade installation file. The file name should have following format: **681AxxSx.exe** (xx refers to version numbers).
2. Copy the file to the Bootable USB Disk.

**Step 3: Run the upgrade program on the DA-681A Computer**

1. Reboot the computer, press F2 while booting up to go to the Boot Manager
2. Select USB Disk as the first boot source. Press Enter to continue.



- When boot up finishes, DOS screen will show up. Go to the directory where the upgrade file is located. For example, if the upgrade file is stored in the DA681A folder, type cd DA681A

```
C:\cd DA681A
```

- Run the upgrade program by typing **681A10S6.exe**. Please note that the upgrade filename may vary depending on the versions.

```
C:\ DA681A>681A10S6.exe
```

- The upgrade program will be automatically performed. Please wait until the procedure to be finished.

```
C:\681A10S3.exe  
Reading file...  
flash package mode.  
Option: -BIOS -C -Desc -ME
```

**Please do not remove the AC power!**

```
Insyde Flash Utility for InsydeH20  
Version 1.5t
```

```
Initializing
```

```
Current BIOS Model name: DA-681A  
New BIOS Model name: DA-681A
```

```
Current BIOS version: V1.00S03  
New BIOS version: V1.00S03
```

```
Updating Block at FFDE8000
```



#### ATTENTION

Do NOT switch off the power supply during the BIOS upgrade, since doing so may cause the system to crash.

## Safety Installation Instructions

---

### RTC Battery Warning

**CAUTION:** There is a risk of explosion if battery is replaced by an incorrect type. Dispose of used batteries according to the instructions.

### Fuse Warning

**CAUTION:** For continued protection against fire, replace only with same type and rating of fuse.

### Rack mount Warning

The following or similar rack mount instructions are included with the installation instructions:

**(1) Elevated Operating Ambient:** If installed in a closed or multi-unit rack assembly, the operating ambient temperature of the rack environment may be greater than the room ambient temperature. Therefore, consideration should be given to installing the equipment in an environment compatible with the maximum ambient temperature (T<sub>ma</sub>) specified by the manufacturer.

**(2) Reduced Air Flow:** Installation of the equipment in a rack should be such that the amount of air flow required for safe operation of the equipment is not compromised.

**(3) Mechanical Loading:** Mounting of the equipment in the rack should be such that a hazardous condition is not achieved due to uneven mechanical loading.

**(4) Circuit Overloading:** Consideration should be given to the connection of the equipment to the supply circuit and the effect that overloading of the circuits might have on overcurrent protection and supply wiring. Appropriate consideration of equipment nameplate ratings should be used when addressing this concern.

**(5) Reliable Grounding:** Reliable grounding of rack mounted equipment should be maintained. Particular attention should be given to supply connections other than direct connections to the branch circuit (e.g., by using power strips).

## Regulatory Statement Approval

---



This device complies with part 15 of the FCC Rules. Operation is subject to the following two conditions: (1) This device may not cause harmful interference, and (2) this device must accept any interference received, including interference that may cause undesired operation.

**Class A:** FCC Warning! This equipment has been tested and found to comply with the limits for a Class A digital device, pursuant to part 15 of the FCC Rules. These limits are designed to provide reasonable protection against harmful interference when the equipment is operated in a commercial environment. This equipment generates, uses, and can radiate radio frequency energy and, if not installed and used in accordance with the instruction manual, may cause harmful interference to radio communications. Operation of this equipment in a residential area is likely to cause harmful interference in which case the user will be required to correct the interference at his own expense.



*European Community*

**Warning:**

This is a Class A product. In a domestic environment this product may cause radio interference in which case the user may be required to take adequate measures.