

Moxa's Managed Switch Next Generation OS User's Manual

Version 1.0, April 2020

www.moxa.com/product

Models covered by this user's manual:

MDS-G4000 Series Managed Ethernet Switches



© 2020 Moxa Inc. All rights reserved.

Moxa's Managed Switch Next Generation OS User's Manual

The software described in this manual is furnished under a license agreement and may be used only in accordance with the terms of that agreement.

Copyright Notice

© 2020 Moxa Inc. All rights reserved.

Trademarks

The MOXA logo is a registered trademark of Moxa Inc.
All other trademarks or registered marks in this manual belong to their respective manufacturers.

Disclaimer

Information in this document is subject to change without notice and does not represent a commitment on the part of Moxa.

Moxa provides this document as is, without warranty of any kind, either expressed or implied, including, but not limited to, its particular purpose. Moxa reserves the right to make improvements and/or changes to this manual, or to the products and/or the programs described in this manual, at any time.

Information provided in this manual is intended to be accurate and reliable. However, Moxa assumes no responsibility for its use, or for any infringements on the rights of third parties that may result from its use.

This product might include unintentional technical or typographical errors. Changes are periodically made to the information herein to correct such errors, and these changes are incorporated into new editions of the publication.

Technical Support Contact Information

www.moxa.com/support

Moxa Americas

Toll-free: 1-888-669-2872
Tel: +1-714-528-6777
Fax: +1-714-528-6778

Moxa Europe

Tel: +49-89-3 70 03 99-0
Fax: +49-89-3 70 03 99-99

Moxa India

Tel: +91-80-4172-9088
Fax: +91-80-4132-1045

Moxa China (Shanghai office)

Toll-free: 800-820-5036
Tel: +86-21-5258-9955
Fax: +86-21-5258-5505

Moxa Asia-Pacific

Tel: +886-2-8919-1230
Fax: +886-2-8919-1231

Table of Contents

1. About This Manual	1-1
Symbols for the Meanings in the Web Interface Configurations.....	1-2
About Note, Attention, and Warning.....	1-3
Configuration Reminders.....	1-4
A: About Mandatory Parameters.....	1-4
B: Configurations before Enable/Disable.....	1-4
2. Getting Started	2-1
Log in by Web Interface	2-2
Connecting to the Switch.....	2-3
Log in by RS-232 Console.....	2-4
Log in by Telnet.....	2-7
3. Web Interface Configuration	3-1
Function Introduction	3-2
Device Summary	3-3
Model Information	3-4
Panel Status	3-4
Event Summary (Last 3 Days)	3-6
CPU Utilization History	3-7
Top 5 Interface Error Packet	3-7
Top 5 Interface Utilization	3-8
System.....	3-9
System Management	3-9
Account Management.....	3-18
Network	3-23
Time.....	3-32
Port	3-37
Port Interface	3-38
Link Aggregation	3-42
PoE	3-45
Layer 2 Switching	3-53
VLAN	3-53
MAC	3-62
QoS.....	3-64
Multicast	3-81
Network Redundancy	3-87
Layer 2 Redundancy	3-88
Management.....	3-107
Network Management.....	3-107
Security.....	3-113
Device Security	3-114
Network Security.....	3-120
Authentication	3-134
Login Authentication	3-134
Diagnostics	3-138
System Status	3-139
Event Notification	3-144
Diagnosis	3-151
Maintenance and Tool	3-161
Standard/Advanced Mode.....	3-161
Disable Auto Save	3-162
Locator	3-163
Reboot.....	3-164
Reset to Default.....	3-165
Log Out of the Switch	3-165
A. Account Privileges List	A-1
Account Privileges List.....	A-2
B. Event Log Description	B-1
Event Log Description	B-2
C. SNMP MIB File	C-1
Standard MIB Installation Order	C-2
MIB Tree	C-3

About This Manual

Thank you for purchasing Moxa's managed switch. Read this user's manual to learn how to connect your Moxa switch with various interfaces and how to configure all settings and parameters via the user-friendly web interface.

Three methods can be used to connect to the Moxa's switch, which all will be described in the next two chapters. See the following descriptions for each chapter's main functions.

Chapter 2: Getting Started

In this chapter, we explain the instruction on how to initialize the configuration on Moxa's switch. We provide three interfaces to access the configuration settings: RS-232 console interface, telnet interface, and web interface.

Chapter 3: Web Interface Configuration

In this chapter, we explain how to access a Moxa switch's various configuration, monitoring, and management functions. The functions can be accessed by web browser. We describe how to configure the switch functions via web interface, which provides the most user-friendly way to configure a Moxa switch.

Appendix A: Account Privileges List

This appendix describes the read/write access privileges for different accounts on Moxa's Managed Ethernet Series switch.

Appendix B: Event Log Description























In this appendix, users can check the event log name and its event log description. When any event occurs, this appendix helps users quickly check the detailed definition for each event.

Appendix C: SNMP MIB File

This appendix contains the SNMP MIB files so that users can manage the entities in a network with Moxa's switch.

Symbols for the Meanings in the Web Interface Configurations

The Web Interface Configuration includes various symbols. For your convenience, refer to the following table for the meanings of the symbols.

Symbols	Meanings
	Add
	Read detailed information
	Clear all
	Column selection
	Refresh
	Enable/Disable Auto Save When Auto Save is disabled, users need to click this icon to save the configurations.
	Export*
	Edit
	Re-authentication
	Delete
	Panel View
	Expand
	Collapse
	Hint Information
	Settings
	Data Comparison
	Menu icon
	Change mode
	Locator
	Reboot
	Reset to default
	Logout
	Increase

Symbols	Meanings
↓	Decrease
↕	Equal
≡	Menu
🔍	Search

*The **Export** function helps users save the current configurations or information for the specific functions. It is located on the upper part of the configuration area. There are two formats available: **CSV**, or **PDF**. Select the format and save in your local computer.

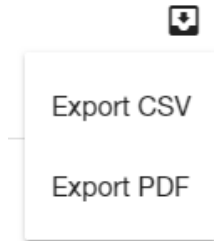

About Note, Attention, and Warning

Throughout the whole manual, users will see some notes, attentions, and warnings. Here are the explanations for each definition.

Note: It indicates the additional explanations for the situation that users might encounter. Here is the example:

NOTE By default, the password assigned to the Moxa switch is moxa. Be sure to change the default password after you first log in to help keep your system secure.

Attention: It indicates the situations where users might take some extra care or it might bring some problems. Here is the example:

 **ATTENTION** When a different type of module has been inserted into the switch, we suggest you configure the settings, or use reset-to-default.

Warning: It indicates the situations where users need to pay particular attention to, or it might bring serious damage to the system or the switch. Here is an example:

 **WARNING** There is a risk of explosion if the battery is replaced by an incorrect type.

Configuration Reminders

In this section, several examples will be used to remind users when configuring the settings for Moxa’s switch.

A: About Mandatory Parameters

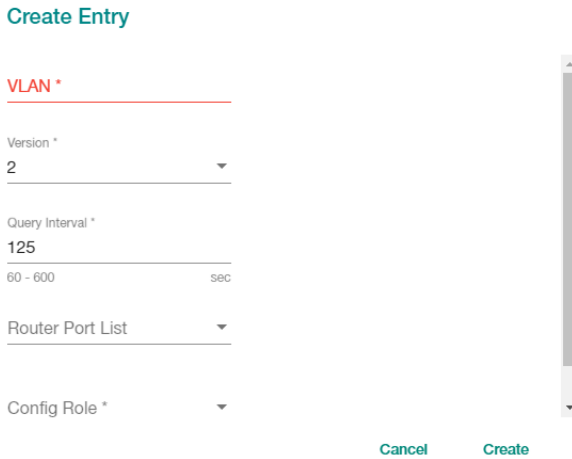

1. The items with asterisks mean they are mandatory parameters that must be provided. In the figure above, the parameters for VLAN, Version, and Query Interval all need to be provided, or it will not be created or applied.
2. If the item is marked with red it means this item has been skipped. You need to fill in the parameters or you cannot apply or create the function.

In addition, some parameter values will be limited to a specific range. If the values exceed the range, it cannot be applied or created.

B: Configurations before Enable/Disable

In another situation, some settings can be configured first, but remain disabled. Users can decide to enable them when necessary without configuring the same settings again. This is particularly convenient and user-friendly when configuring various settings. For example, in Spanning Tree configuration page, users can configure the Guard settings first, but later select to disable the Guard settings in the **General** tab. When users decide to enable the Guard settings, they only need to select **Enable** in General settings, so that the Guard setting can be enabled at the same time.

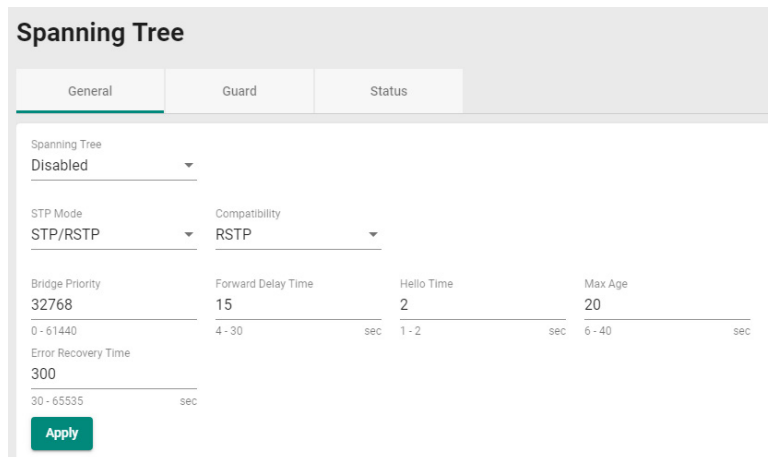

2

Getting Started

In this chapter, we explain how to log in a Moxa's switch for the first time. There are three ways to access the Moxa switch's configuration settings: RS-232 console, or web-based interface.

The following topics are covered in this chapter:

- ❑ **Log in by Web Interface**
 - Connecting to the Switch
- ❑ **Log in by RS-232 Console**
- ❑ **Log in by Telnet**

Log in by Web Interface

You can directly connect Moxa's switch to your computer with a standard network cable or install your computer at the same intranet as your switch. Then you need to configure your computer's network setting. The default IP address for the Moxa's switch is:

192.168.127.253

For example, you can configure the computer's IP setting as **192.168.127.99**, and the subnet mask as 255.255.255.0.

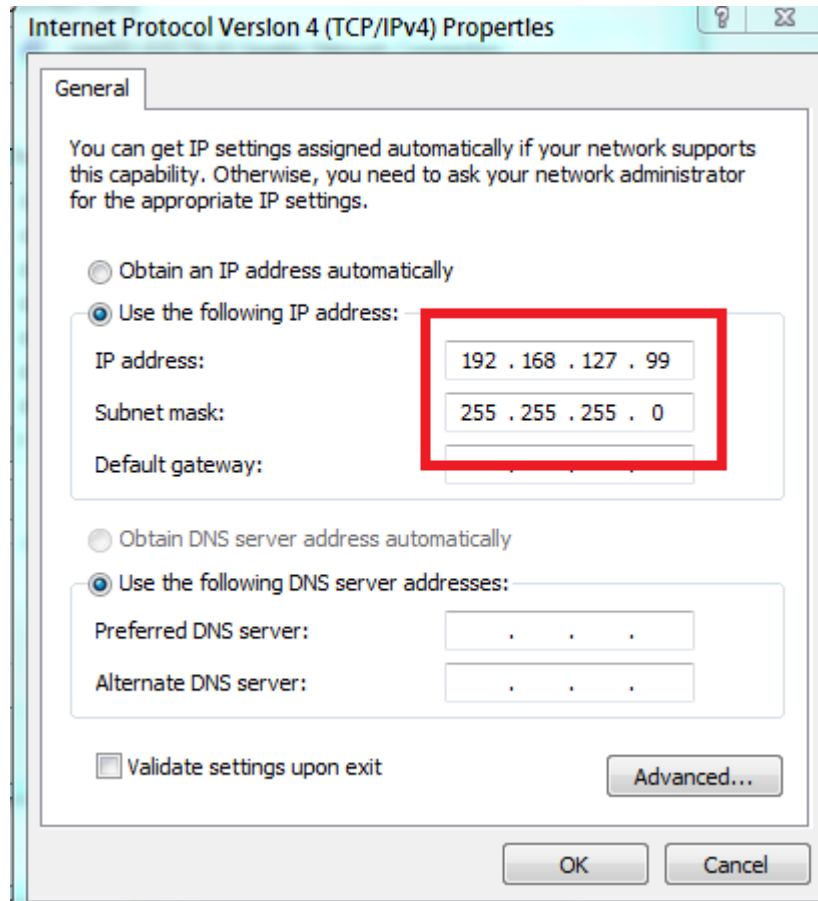

Click **OK** when finished.

Connecting to the Switch

Open a browser, such as Google Chrome, Internet Explorer 11, or Firefox, and connect to the following IP address:

http://192.168.127.253



The default username and password are:

Username: **admin**

Password: **moxa**

Click **Login** to continue. If you have logged in before, you will see a screen indicating the previous login information. Click **Close**.

System Message

Welcome admin

The latest successful login time was: 2018-12-21 19:04:22.

Close

Another system message will appear, reminding you to change the default password. We recommend you change your password, or a message will appear whenever you log in. You can change the password in the **Account Management** section. Click **Close** to continue.

Log in by RS-232 Console

The Moxa's managed switch offers a serial console port, allowing users to connect to the switch and configure the settings. Do the following steps for the serial connection and configuration.

1. Prepare an RS-232 serial cable with an RJ45 interface.
2. Connect the RJ45 interface end to the console port on the switch, and the other end to the computer.
3. We recommend you use **PComm Terminal Emulator** for serial communication. The software can be downloaded free of charge from Moxa's website.

After installing PComm Terminal Emulator, open the Moxa switch's console as follows:

1. From the Windows desktop, click **Start → Moxa → PComm Terminal Emulator**.

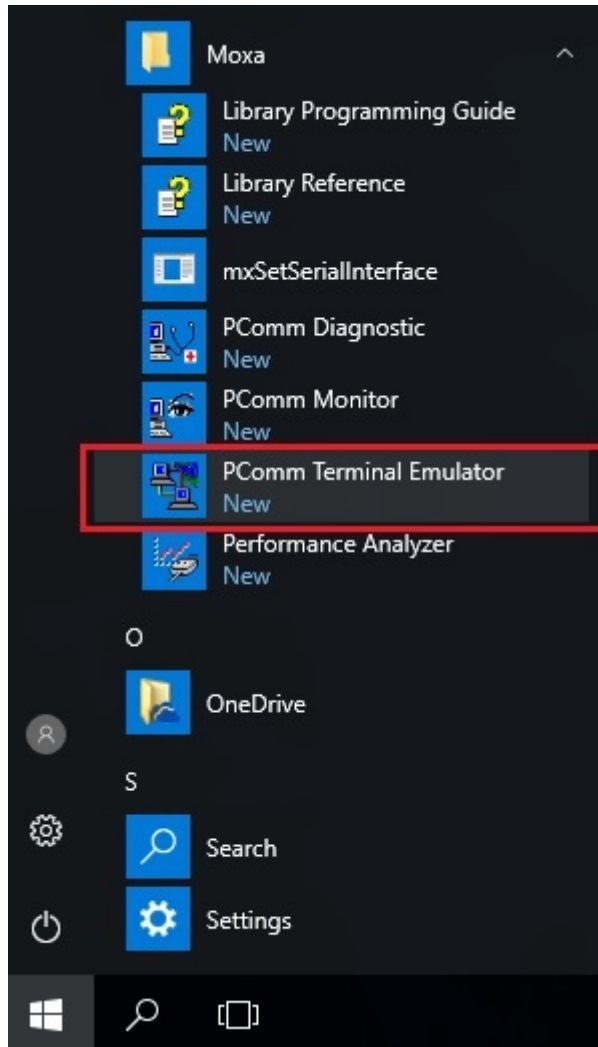

2. Select **Open** under the **Port Manager** menu to open a new connection.

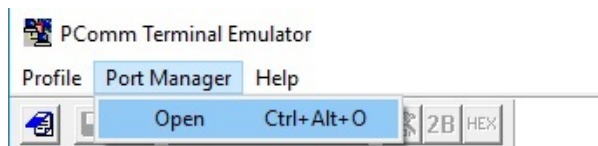

3. The **Property** window should open. On the **Communication Parameter** tab for **Ports**, select the COM port that is being used for the console connection. Set the other fields as follows: **115200** for **Baud Rate**, **8** for **Data Bits**, **None** for **Parity**, and **1** for **Stop Bits**.

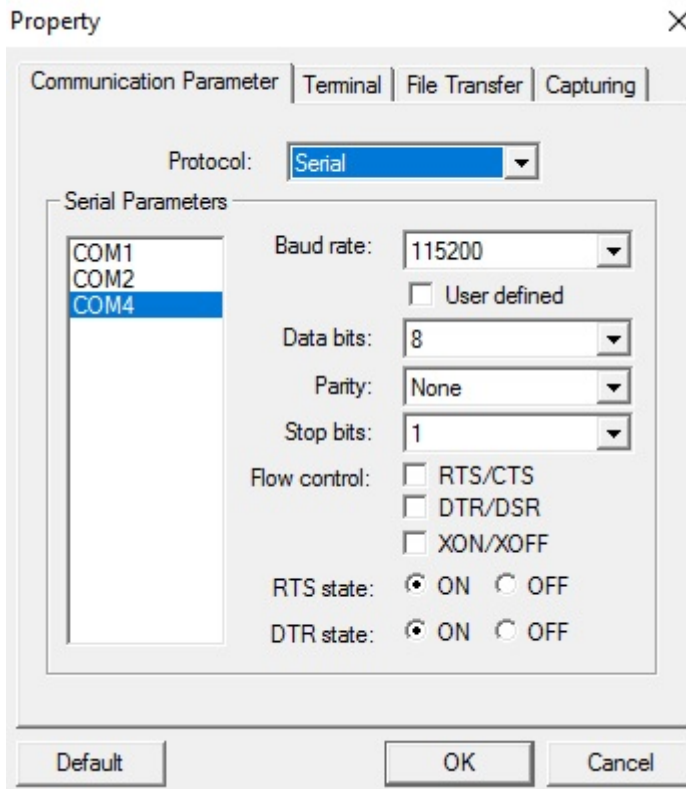

4. On the **Terminal** tab, select **VT100** for **Terminal Type**, and then click **OK** to continue.

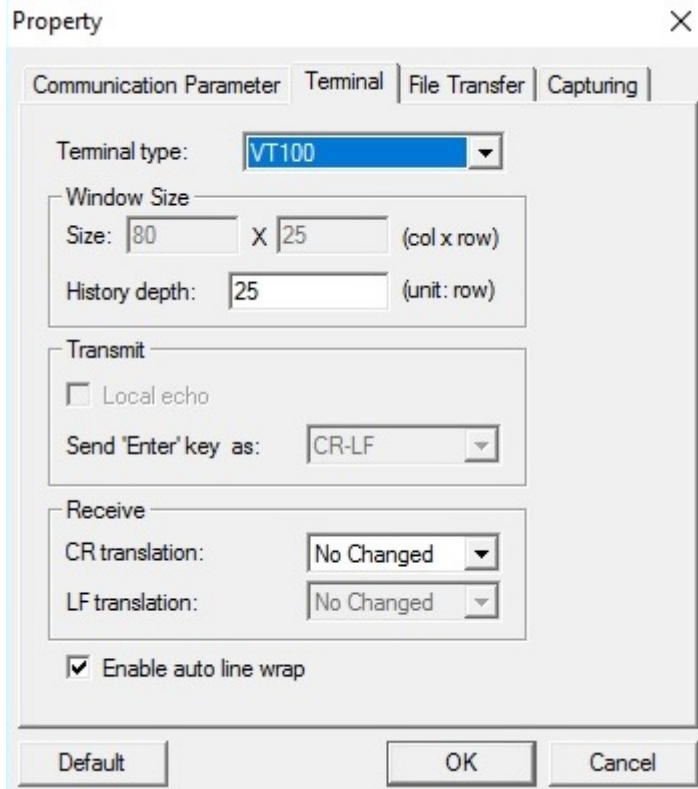

- The console will prompt you to log in. The default login name is **admin**, and the default password is **moxa**. This password will be required to access any of the consoles (web, serial, Telnet).

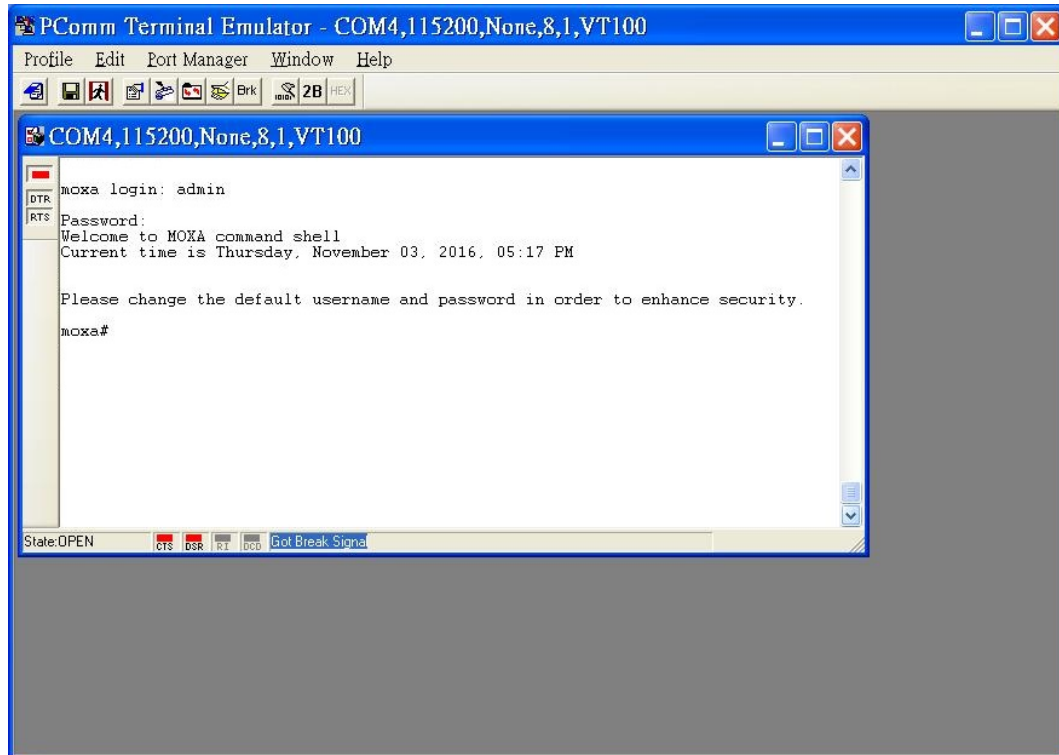

- After successfully connecting to the switch by serial console, users can start configuring the switch parameters by using command line instructions. Refer to the **Moxa Command Line Interface Manual**.

NOTE By default, the password assigned to the Moxa switch is **moxa**. Be sure to change the default password after you first log in to help keep your system secure.

Log in by Telnet

Opening the Moxa switch's Telnet or web console over a network requires that the PC host and Moxa switch are on the same logical subnet. You might need to adjust your PC host's IP address and subnet mask. By default, the Moxa switch's IP address is 192.168.127.253 and the Moxa switch's subnet mask is 255.255.255.0. Your PC's IP address must be set to 192.168.xxx.xxx if the subnet mask is 255.255.0.0, or to 192.168.127.xxx if the subnet mask is 255.255.255.0.

NOTE When connecting to the Moxa switch's Telnet or web console, first connect one of the Moxa switch's Ethernet ports to your Ethernet LAN, or directly to your PC's Ethernet port. You can use either a straight-through or cross-over Ethernet cable.

NOTE The Moxa switch's default IP address is 192.168.127.253.

After making sure that the Moxa switch is connected to the same LAN and logical subnet as your PC, open the Moxa switch's Telnet console as follows:

1. Click **Start** → **Run** from the Windows Start menu and then Telnet to the Moxa switch's IP address from the Windows **Run** window. You can also issue the Telnet command from a DOS prompt.

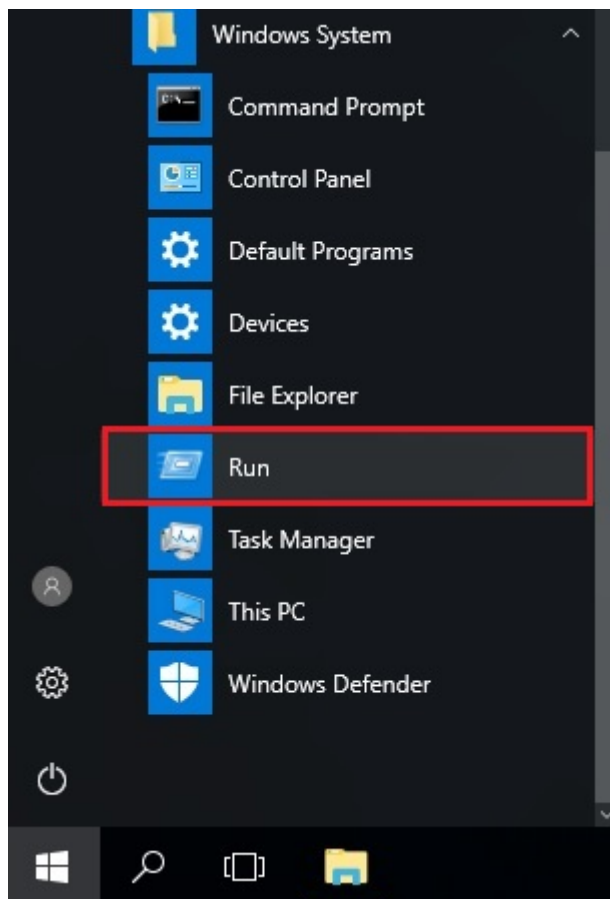

- Next, use Telnet to connect the Moxa switch's IP address (192.168.127.253) from the Windows **Run** window. You can also issue the Telnet command from a DOS prompt.

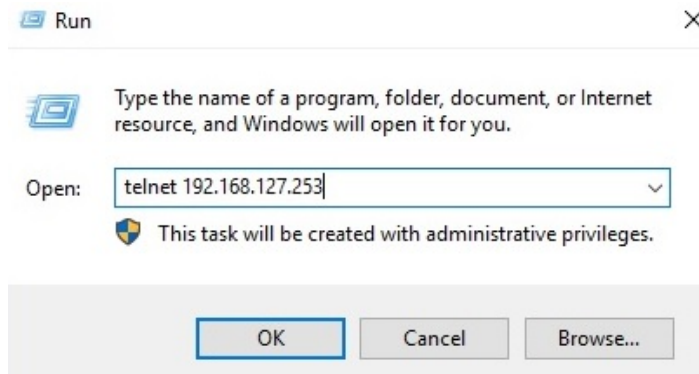

- The Telnet console will prompt you to log in. The default login name is **admin**, and the password is **moxa**. This password will be required to access any of the consoles (web, serial, Telnet).

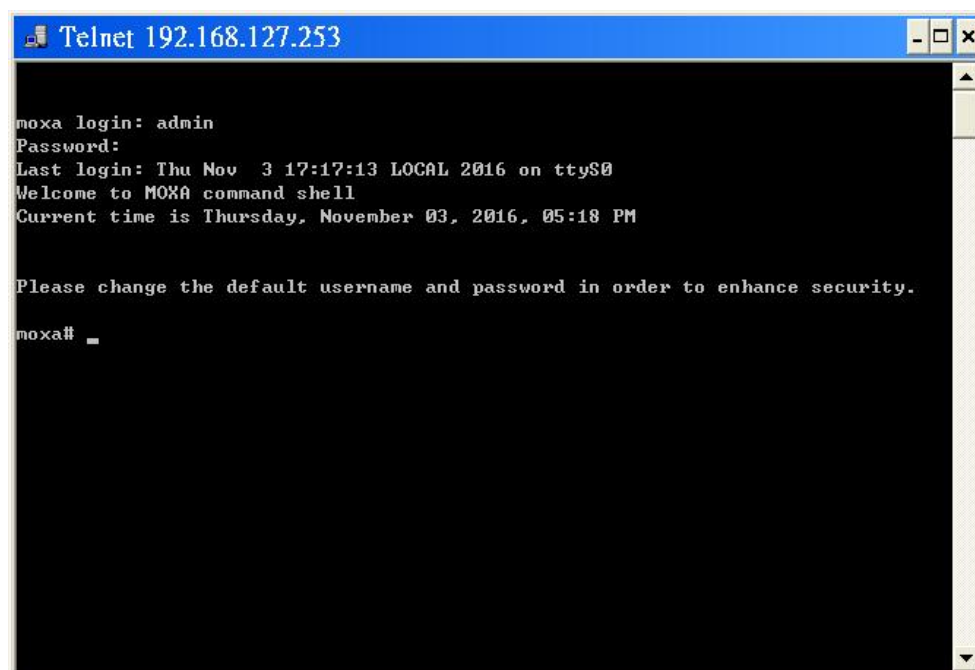

- After successfully connecting to the switch by Telnet, users can start configuring the switch parameters by using command line instructions. Refer to the **Moxa Command Line Interface Manual**.

NOTE By default, the password assigned to the Moxa switch is **moxa**. Be sure to change the default password after you first log in to help keep your system secure.

Web Interface Configuration

Moxa's managed switch offers a user-friendly web interface for easy configurations. Users find it simple to configure various settings over the web interface. All configurations for the Moxa's managed switch can be easily set up and done via this web interface, essentially reducing system maintenance and configuration effort.

The following topics are covered in this chapter:

❑ **Function Introduction**

❑ **Device Summary**

- Model Information
- Panel Status
- Event Summary (Last 3 Days)
- CPU Utilization History
- Top 5 Interface Error Packet
- Top 5 Interface Utilization

❑ **System**

- System Management
- Account Management
- Network
- Time

❑ **Port**

- Port Interface
- Link Aggregation
- PoE

❑ **Layer 2 Switching**

- VLAN
- MAC
- QoS
- Multicast

❑ **Network Redundancy**

- Layer 2 Redundancy

❑ **Management**

- Network Management

❑ **Security**

- Device Security
- Network Security
- Authentication
- Login Authentication

❑ **Diagnostics**

- System Status
- Event Notification
- Diagnosis

❑ **Maintenance and Tool**

- Standard/Advanced Mode
- Disable Auto Save
- Locator
- Reboot
- Reset to Default
- Log Out of the Switch

Function Introduction

This section describes the web interface design, providing a basic visual concept for users to understand the main information or configuration menu for the web interface pages.

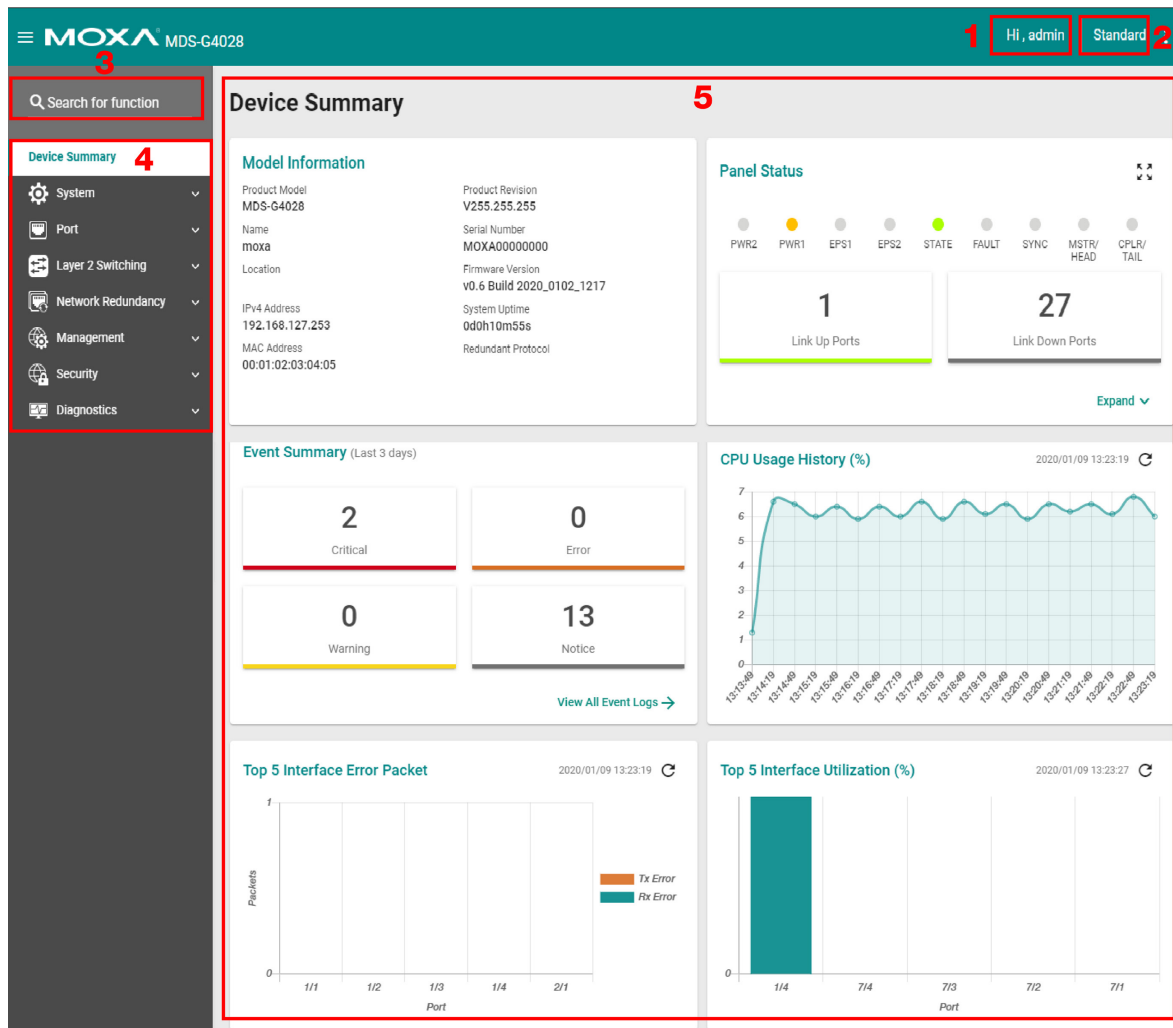

1. **Login Name:** It shows the role of the login name.
2. **Configuration Mode:** Two modes can be shown: **Standard Mode** and **Advanced Mode**.
 - **Standard Mode:** Some of the features and parameters will be hidden to make the configurations simpler (default).
 - **Advanced Mode:** More features and parameters will be shown for users to configure detailed settings.
3. **Search Bar:** Type the items you want to search of the function menu tree.
4. **Function Menu:** All functions of the switch are shown here. Click the function you want to view or configure.
5. **Device Summary:** All important device information of the functions will be shown here.

Device Summary

After successfully connecting to the switch, the **Device Summary** will automatically appear. You can view the whole web interface on the screen. If you are in the middle of performing configurations, simply click **Device Summary** on the Function Menu and you can view the detailed information of the switch.

Device Summary

Model Information

Product Model MDS-G4028	Product Revision V255.255.255
Name moxa	Serial Number MOXA00000000
Location	Firmware Version v0.6 Build 2020_0102_1217
IPv4 Address 192.168.127.253	System Uptime 0d0h10m55s
MAC Address 00:01:02:03:04:05	Redundant Protocol

Panel Status

PWR2 PWR1 EPS1 EPS2 STATE FAULT SYNC MSTR/HEAD CPLR/TAIL

1
Link Up Ports

27
Link Down Ports

[Expand](#) ▾

Event Summary (Last 3 days)

2 Critical	0 Error
0 Warning	13 Notice

[View All Event Logs](#) →

CPU Usage History (%)

2020/01/09 13:23:19 [↻](#)

Top 5 Interface Error Packet

2020/01/09 13:23:19 [↻](#)

Top 5 Interface Utilization (%)

2020/01/09 13:23:27 [↻](#)

See the following sections for detailed descriptions for the specific items.

3-3

Model Information

This shows the model information, including product model name, serial number, firmware version, system uptime, etc.

Model Information

Product Model	Product Revision
MDS-G4028	V255.255.255
Name	Serial Number
moxa	MOXA00000000
Location	Firmware Version
	v0.6 Build 2020_0102_1217
IPv4 Address	System Uptime
192.168.127.253	0d1h17m52s
MAC Address	Redundant Protocol
00:01:02:03:04:05	

Panel Status

This section illustrates the panel status. For example, the connecting ports will be shown in green, while the disconnected ports will be shown in gray. Click **Expand** to view more detailed information on the panel status and click **Collapse** to return.

Panel Status 

PWR2 PWR1 EPS1 EPS2 STATE FAULT SYNC MSTR/HEAD CPLR/TAIL

1 Link Up Ports 27 Link Down Ports

Expand 

Click **Expand** to view more detailed information on the panel status and click **Collapse** to return.

Panel Status 

PWR2 PWR1 EPS1 EPS2 STATE FAULT SYNC MSTR/HEAD CPLR/TAIL

1 Link Up Ports 27 Link Down Ports

Module 1 - MDS-G4028

MS 1/1 1/2 1/3 1/4

Collapse 

Panel View

By clicking this icon, , users can view the device port status by a graphic figure. Click the close icon on the upper right corner to return to the main page.

This panel view figure might vary, depending on the different modules that you purchase.



Event Summary (Last 3 Days)

This section shows the event summary for the past three days.

Event Summary (Last 3 days)

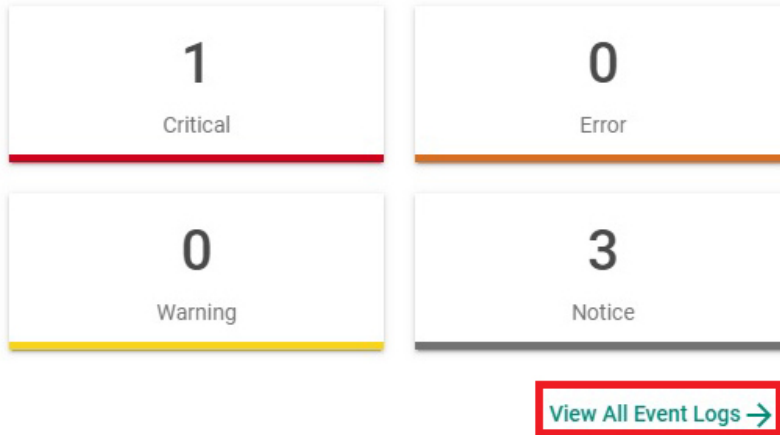

Click **View All Event Logs** to go to the Event Log page, where you can view all event logs.

Event Log

Event Log

Threshold Setting

Oversize-Action

Overwrite the oldest event log ▼

Apply

🔄 🗑️ 📄

Index	Bootup Number	Severity	Timestamp	Uptime	Message
1	3	Notice	2018-12-21 20:11:13	0d1h17m46s	Configuration [Account] changed by admin.
2	3	Notice	2018-12-21 20:06:40	0d1h13m13s	[Account:admin] successfully logged in via local.
3	3	Notice	2018-12-21 19:04:22	0d0h10m55s	[Account:admin] successfully logged in via local.
4	3	Info	2018-12-21 19:01:42	0d0h8m15s	LLDP remote table changed.

For Event Log settings, refer to **Event Log** under the **Diagnosis** section.

CPU Utilization History

This section shows the CPU usage. The data will be shown as a percentage over time. Click the refresh icon on the page to show the latest information.

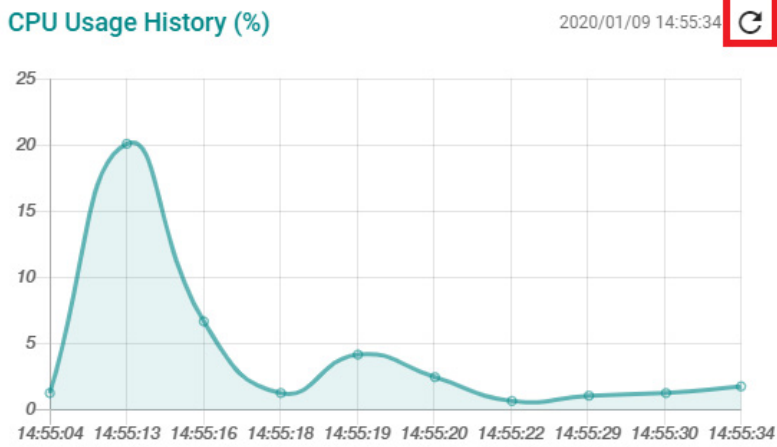

Top 5 Interface Error Packet

If any error packets occur, top 5 error packets will be shown here. Click the refresh icon on the page to show the latest information.

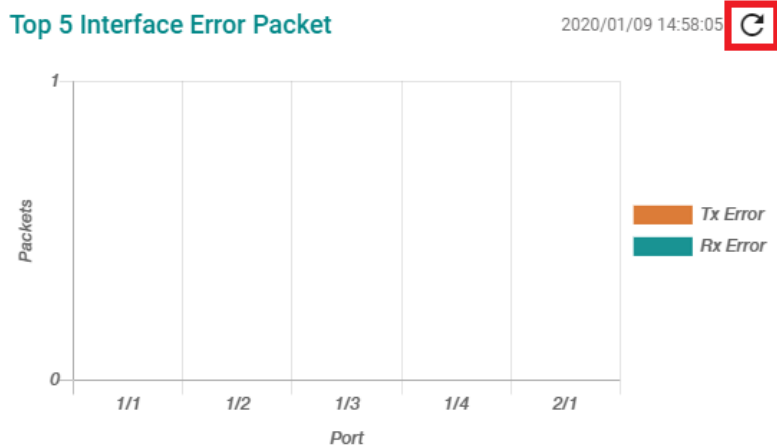

Top 5 Interface Utilization

The top 5 interface utilizations will be shown here. Click the refresh icon on the page to show the latest information.

Top 5 Interface Utilization (%)

2020/01/09 15:05:29

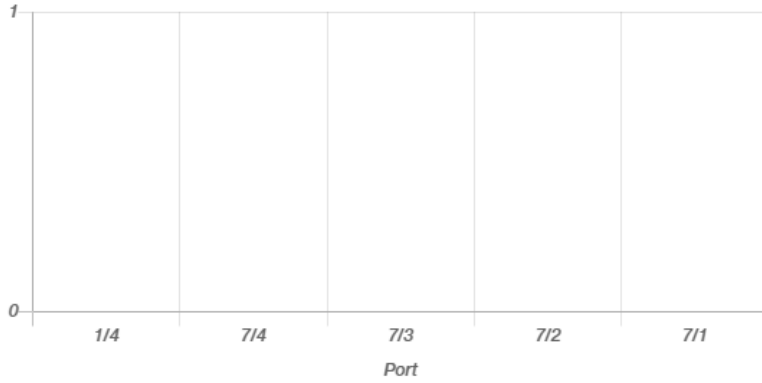

System

Click **System** on the function menu. You can configure the **System Management**, **Account Management**, **Network**, and **Time** configurations.

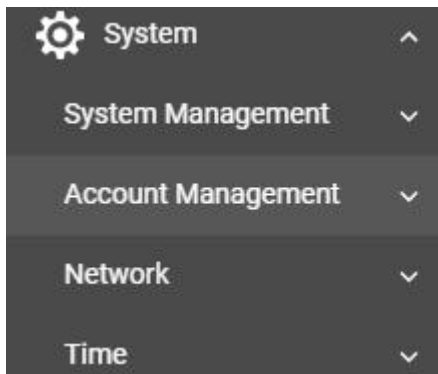

System Management

Click **System Management**, four functions can be configured under this section: **Information Setting**, **Firmware Upgrade**, **Configure Backup and Restore**, and **Event Log Backup**.

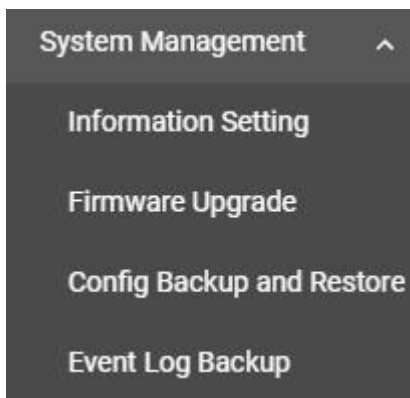

Information Setting

Define **Information Setting** items to make it easier to identify different switches that are connected to your network.

Information Setting

Device Name
moxa

4 / 255

Location

0 / 255

Description

0 / 255

Contact Information

0 / 255

Apply

Device Name

Setting	Description	Factory Default
1 to 255 characters	This option is useful for differentiating between the roles or applications of different units. Note that the device name cannot be empty.	moxa

NOTE The Device Name field follows the PROFINET I/O naming rule. The name can only include the following characters, **a-z/0-9/-**. The prefix cannot start from port-x where x=0~9.

Location

Setting	Description	Factory Default
Max. 255 characters	This option is for differentiating between the locations of different switches. Example: production line 1.	None

Description

Setting	Description	Factory Default
Max. 255 characters	This option is for recording a more detailed description of the unit.	None

Contact Information

Setting	Description	Factory Default
Max. 255 characters	Users can input contact information such as email address, or telephone number when problems occur.	None

When finished, click **Apply** to save your changes.

Firmware Upgrade

There are three ways to update your Moxa switch’s firmware: from a local *.rom file, by remote SFTP server, and remote TFTP server.

Local

Select **Local** tab.

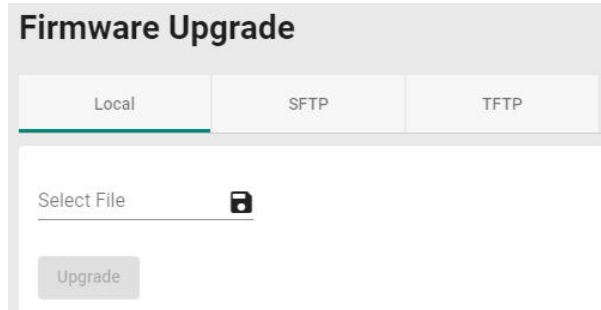

Select File

Before performing firmware upgrade, download the updated firmware (*.rom) file first from Moxa’s website (www.moxa.com).

Setting	Description	Factory Default
Select the firmware file	Select the firmware file from the location where the updated firmware is located.	None
Browse for the (*.rom) file, and then click the Upgrade button.	This option allows users to select the updated firmware file and perform the firmware upgrade.	None

SFTP

Select **SFTP** tab.

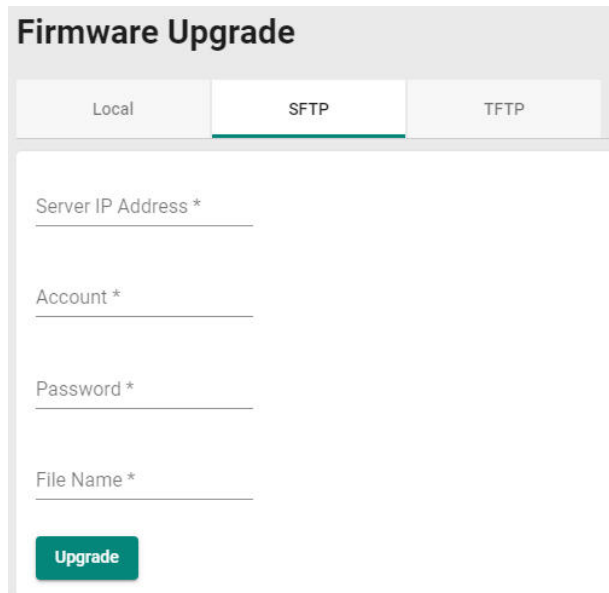

Server IP Address

Setting	Description	Factory Default
Input the IP address of the SFTP server.	Input the server IP address of the computer where the new firmware file (*.rom) is located.	None

Account

Setting	Description	Factory Default
Input the account of the SFTP server	The account must be authorized in order for the SFTP Server to have a secure connection.	None

Password

Setting	Description	Factory Default
Input the password for the SFTP server	The account has to be specified in order to authorize the SFTP Server for secure connection.	None

File Name

Setting	Description	Factory Default
Input the file name of the firmware	Input the file name of the new firmware.	None

When finished, click **Upgrade** to perform the firmware upgrade. The switch will reboot automatically and perform the firmware upgrade.

TFTP Server

Users can also upgrade firmware via the TFTP server. Click **TFTP** tab first.

The screenshot shows the 'Firmware Upgrade' section of a web interface. At the top, there are three tabs: 'Local', 'SFTP', and 'TFTP'. The 'TFTP' tab is currently selected and highlighted with a green underline. Below the tabs, there are two input fields: 'Server IP Address *' and 'File Name *'. At the bottom left of the form area, there is a green 'Upgrade' button.

Server IP Address

Setting	Description	Factory Default
Input the IP address of the TFTP server	Input the IP address of the TFTP server where the new firmware file (*.rom) is located.	None

File Name

Setting	Description	Factory Default
Input the file name of the firmware	Input the file name of the new firmware.	None

When finished, click **Upgrade** to perform the firmware upgrade.

Configuration Backup and Restore

There are three ways to back up and restore your Moxa switch’s configuration: from a local configuration file, by remote SFTP server, or by remote TFTP server. In addition, file encryption is also provided for your safety concern.

Local

Click **Local** tab first.

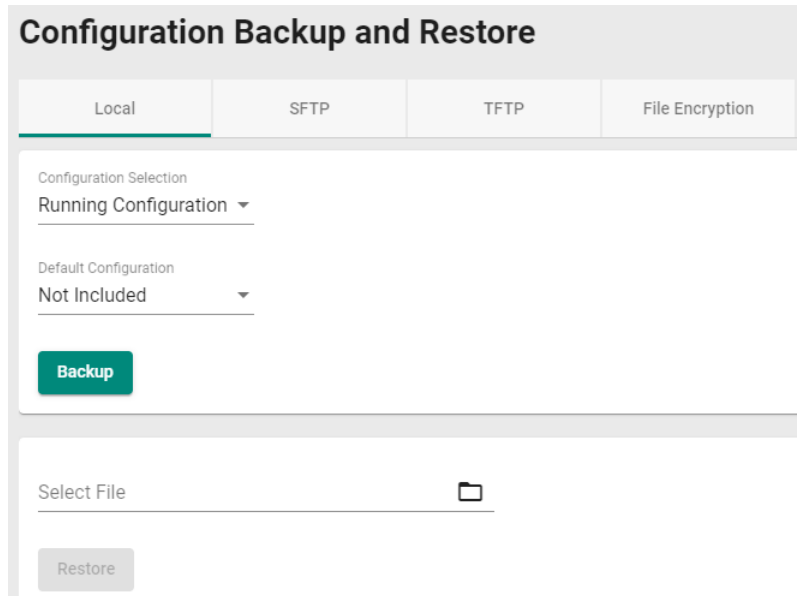

Configuration Selection

Setting	Description	Factory Default
Running Configuration	Back up the running configuration.	Running
Startup Configuration	Back up the start-up configuration.	Configuration

Default Configuration

Setting	Description	Factory Default
Not Included	Back up the configuration without default settings.	Not Included
Included	Back up the configuration with default settings.	

Select File

Setting	Description	Factory Default
Click the Backup button to back up the configuration file to a local drive.	Back up the system file to your local computer.	None
Browse for a configuration file on a local disk, and then click the Restore button.	Select the configuration file and perform system restoration.	None

SFTP Server

Click **SFTP** tab first.

Configuration Backup and Restore

Local
SFTP
TFTP
File Encryption

Server IP Address *

Account *

Password *

File Name *

Backup
Restore

Server IP Address

Setting	Description	Factory Default
Input the IP address of the SFTP server	Input the IP address of the SFTP server where the new firmware file (*.rom) is located.	None

Account

Setting	Description	Factory Default
Input the account of the SFTP server	An account must be provided to authorize the SFTP server for secure connection.	None

Password

Setting	Description	Factory Default
Input the passwords for the SFTP server	The password has to be specified in order to authorize the SFTP Server for secure connection.	None

File Name

Setting	Description	Factory Default
Input the backup/restore file name (support up to 54 characters, including the .ini file extension).	Input the file name of the configuration backup or restoration file.	None

When finished, click **Backup or Restore** to back up or restore the system configuration file.

TFTP Server

Click **TFTP** tab first.

The screenshot shows the 'Configuration Backup and Restore' web interface. At the top, there are four tabs: 'Local', 'SFTP', 'TFTP', and 'File Encryption'. The 'TFTP' tab is currently selected and highlighted with a green underline. Below the tabs, there are two input fields: 'Server IP Address *' and 'File Name *'. At the bottom of the form, there are two green buttons labeled 'Backup' and 'Restore'.

Server IP Address

Setting	Description	Factory Default
Input the IP address of the TFTP server	Users can input the IP address of the TFTP server.	None

File Name

Setting	Description	Factory Default
Input the backup/restore file name (supports up to 54 characters, including the .ini file extension).	Users can input the file name to back up or restore the system configuration file.	None

When finished, click **Backup** or **Restore** to perform the firmware upgrade.

File Encryption

To encrypt the configuration file, click the **File Encryption** tab first.

The screenshot shows the 'Configuration Backup and Restore' web interface with the 'File Encryption' tab selected. Below the tabs, there is a dropdown menu labeled 'Configuration File Encryption' with 'Disabled' selected. Below that is a 'Password' input field. At the bottom, there is a green button labeled 'Apply'.

Enable Configuration File Encryption

Setting	Description	Factory Default
Enabled	Enable the configuration file to be encrypted.	Disabled
Disabled	Disable the feature that allows the configuration file to be encrypted.	

Password

Setting	Description	Factory Default
4 to 16 characters, numbers only.	Input the password when users encrypt the configuration file.	None

When finished, click **Apply** to save your changes.

Event Log Backup

There are three ways to back up Moxa switch’s log files: from a local drive, by remote SFTP server, or by remote TFTP.

Local

Click **Local** tab.

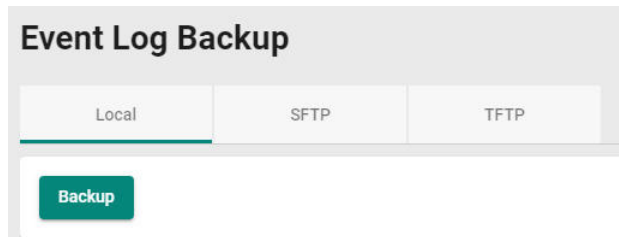

Click **Backup** to back up the log file to a local drive.

SFTP Server

Click **SFTP** tab.

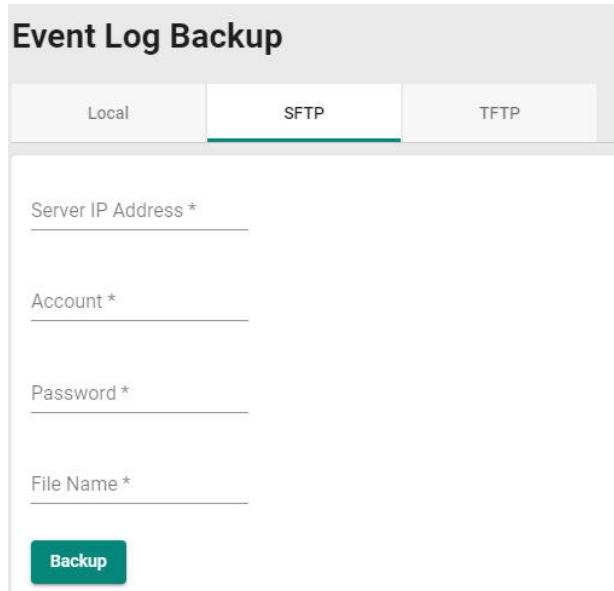

Server IP Address

Setting	Description	Factory Default
Input the IP address of the SFTP server	Users can input the IP address of the SFTP server.	None

Port

Setting	Description	Factory Default
Input the port of the SFTP server, 1 to 65535	Specify the port used in the SFTP server.	None

Account

Setting	Description	Factory Default
Input the account of the SFTP server	An account must be specified to authorize the SFTP server for secure connection.	None

Password

Setting	Description	Factory Default
Input the password for the SFTP server	The password has to be entered in order to authorize the SFTP Server for secure connection.	None

File Name

Setting	Description	Factory Default
Input the file name for event log backup	Users can input the file name of the event log.	None

When finished, click **Backup** to back up the event log file.

TFTP Server

Click **TFTP** tab.

Server IP Address

Setting	Description	Factory Default
Input the IP address of the TFTP server	Users can input the IP address of the TFTP server.	None

Port

Setting	Description	Factory Default
Input the port of the TFTP server, 1 to 65535	Users can input the port used in the TFTP server.	None

File Name

Setting	Description	Factory Default
Input the file name for event log backup	Users can input the file name of the event log.	None

When finished, click **Backup** to back up the event log file.

Account Management

The **Account Management** feature allows users to manage the accounts of the switch. You can enable different accounts with different roles to facilitate convenient management and safe access.

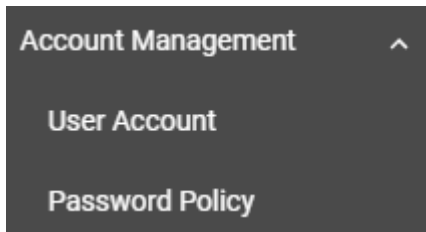

User Account

This section describes how to manage the existing accounts of the switch. Here, you can add, edit, and delete user accounts for the switch. By default, there is only one account: admin. In order to enhance security, we suggest you create a new account with the user authority.

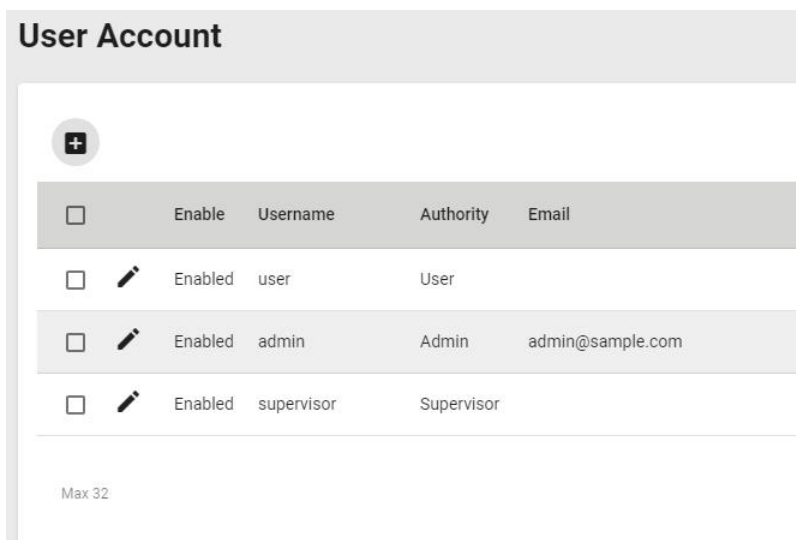
The "User Account" interface features a header with a plus icon for adding new accounts. Below is a table with columns for Enable, Username, Authority, and Email. The table lists three accounts: "user" (User authority), "admin" (Admin authority, email: admin@sample.com), and "supervisor" (Supervisor authority). A "Max 32" limit is noted at the bottom.

<input type="checkbox"/>	Enable	Username	Authority	Email
<input type="checkbox"/>	Enabled	user	User	
<input type="checkbox"/>	Enabled	admin	Admin	admin@sample.com
<input type="checkbox"/>	Enabled	supervisor	Supervisor	

Max 32

There is a search function on the upper right of the User Account page. Type the username you want to search for.

Editing Existing Accounts

Select the account you want to edit and click the edit icon.

User Account

+

	Enable	Username	Authority	Email
<input type="checkbox"/>		Enabled	user	User
<input type="checkbox"/>		Enabled	admin	Admin admin@sample.com
<input type="checkbox"/>		Enabled	supervisor	Supervisor

Max 32

Configure the following settings.

Edit Account Setting

Enable
 Enabled ▼

Username

At least 4 characters 4 / 32

Authority *

New Password *
At least 4 characters 0 / 63

Confirm Password *
At least 4 characters 0 / 63

Email

0 / 63

Cancel
Apply

Enabled

Setting	Description	Factory Default
Enabled	This enables the user account.	Enabled
Disabled	This disables the user account.	

Authority

Setting	Description	Factory Default
admin	This account has read/write access for all configuration parameters.	admin
supervisor	This account has read/write access for some specific configuration parameters.	
user	This account can only view some specific configuration parameters.	

New Password

Setting	Description	Factory Default
4 to 63 characters	Enter the password to use for this account.	None

Confirm Password

Setting	Description	Factory Default
4 to 63 characters	Reenter the password to confirm it.	None

Email

Setting	Description	Factory Default
Input an email address	Input an email address for the account if required.	None

When finished, click **Apply** to save your changes.

NOTE Refer to **Appendix A** for detailed descriptions for read/write access privileges for the admin, supervisor, and user authority levels.

Creating a New Account

You can create new account by clicking the + icon on the configuration page.

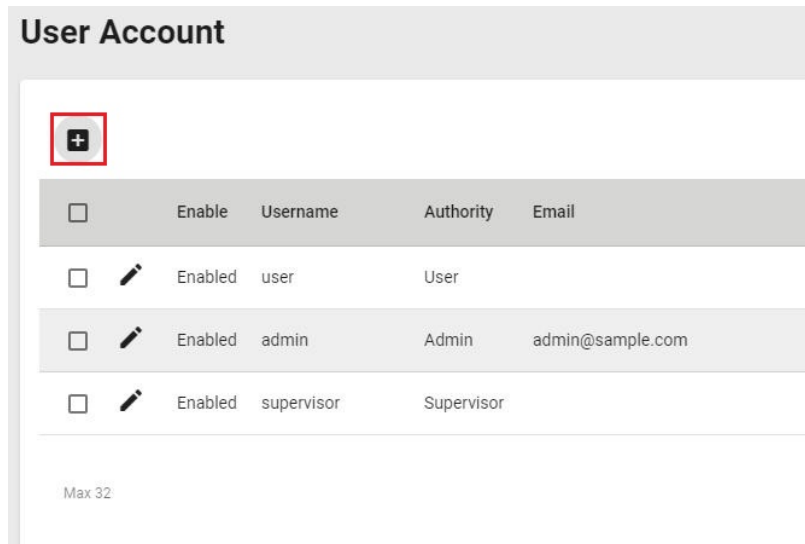

Configure the following settings.

Create New Account

Enable
 Enabled

Username *
 At least 4 characters 0 / 32

Authority *

New Password *
 At least 4 characters 0 / 63

Confirm Password *
 At least 4 characters 0 / 63

Email
 0 / 63

[Cancel](#) [Create](#)

Enabled

Setting	Description	Factory Default
Enabled	This enables the account.	Enabled
Disabled	This disables the account.	

Username

Setting	Description	Factory Default
Input a username, 4 to 32 characters	Input a new username for this account.	None

Authority

Setting	Description	Factory Default
admin	This account has read/write access of all configuration parameters.	None
supervisor	This account has read/write access for some specific configuration parameters.	
user	This account can only view some specific configuration parameters.	

In order to enhance security, we suggest you create a new account with the user authority.

New Password

Setting	Description	Factory Default
4 to 63 characters	Input a new password for this account.	None

Confirm Password

Setting	Description	Factory Default
4 to 63 characters	Reenter the password to confirm.	None

Email

Setting	Description	Factory Default
Input an email address	Input an email address for the account if required.	None

When finished, click **Create** to complete.

Minimum Length

Setting	Description	Factory Default
Input from 4 to 63	This sets the minimum length of the password.	4

Password Complexity Strength Check

Setting	Description	Factory Default
digit, letter cases, special characters	These determine the required complexity for the password. Multiple options may be checked.	None

Password Max-life-time (day)

Setting	Description	Factory Default
Input from 0 to 365	This determines how long the password can be used before it must be changed.	0

When finished, click **Apply** to save your changes.

Network

This section describes how to configure the switch’s network settings, including **IP Configuration** and the **DHCP Server**.

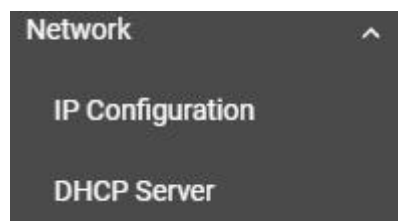

IP Configuration

Users can configure the IP settings of the switch.

IP Configuration

Get IP From
Manual ▼

IP Address *

Subnet Mask

 ▼

Default Gateway

DNS Server 1

DNS Server 2

IPv6 Global Unicast Ad...

IPv6 DNS Server 1

IPv6 DNS Server 2

IPv6 Global Unicast Ad...

IPv6 Link-Local Address

Get IP From

Setting	Description	Factory Default
Manual	The IP address of the switch must be set manually.	Manual
DHCP	The IP address of the switch will be assigned automatically by the network's DHCP server.	

IP Address

Setting	Description	Factory Default
Input the IP address for the switch	Specify the IP address to use for the switch.	192.168.127.253

Subnet Mask

Setting	Description	Factory Default
Input the subnet mask for the switch	Specify the subnet mask to use for the switch.	24(255.255.255.0)

Default Gateway

Setting	Description	Factory Default
Input the IP address for the gateway	Specify the IP address of the gateway that connects the LAN to a WAN or another network.	None

DNS Server 1

Setting	Description	Factory Default
Input the IP address of the 1 st DNS server	Specify the IP address of the 1 st DNS server used by your network. After specifying the DNS server's IP address, you can use the switch's URL (e.g., www.mymoxaswitch.com) to open the web console instead of entering the IP address.	None

DNS Server 2

Setting	Description	Factory Default
Input the IP address of the 2 nd DNS server	Specify the IP address of the 2 nd DNS server used by your network. The switch will use the secondary DNS server if the first DNS server fails to connect.	None

IPv6 Global Unicast Address Prefix (Prefix Length: 64 bits) Default Gateway

Setting	Description	Factory Default
Global Unicast Address Prefix	The prefix value must be formatted according to the RFC 2373 IPv6 Addressing Architecture, using 8 colon-separated 16-bit hexadecimal values. One double colon can be used in the address to indicate the appropriate number of zeros required to fill the undefined fields. Note: This feature is only available in Advanced Mode .	None

IPv6 DNS Server 1

Setting	Description	Factory Default
Input the IPv6 IP address of the 1 st DNS server	Specify the IPv6 address of the 1 st DNS server used by your network. After specifying the DNS server's IP address, you can use the switch's URL (e.g., www.mymoxaswitch.com) to open the web console instead of entering the IP address. Note: This feature is only available in Advanced Mode .	None

IPv6 DNS Server 2

Setting	Description	Factory Default
Input the IPv6 address of the 2 nd DNS server	Specify the IPv6 address of the 2 nd DNS server used by your network. The Moxa switch will use the secondary DNS server if the first DNS server fails to connect. Note: This feature is only available in Advanced Mode .	None

IPv6 Global Unicast Address

Setting	Description	Factory Default
None	Displays the IPv6 Global Unicast address. The network portion of the Global Unicast address can be configured by specifying the Global Unicast Prefix and using an EUI-64 interface ID in the low order 64 bits of the address. The host portion of the Global Unicast address is automatically generated using the modified EUI-64 form of the interface identifier (the switch's MAC address). Note: This feature is only available in Advanced Mode .	None

IPv6 Link-Local Address

Setting	Description	Factory Default
None	The network portion of the Link-Local address is FE80 and the host portion of the Link-Local address is automatically generated using the modified EUI-64 form of the interface identifier (the switch's MAC address). Note: This feature is only available in Advanced Mode .	None

When finished, click **Apply** to save your changes.

DHCP Server

This section describes how to configure the DHCP server settings for Moxa's switch. First, click the **General** tab.



Then select **DHCP / MAC-based IP Assignment**, and click **Apply**.

DHCP

Select the **DHCP** tab and then click the **+** icon on the configuration page to create a new DHCP server pool.



Configure the following parameters.

Create DHCP Server Pool

Enable
 Enabled ▼

Start IP Address * Subnet Mask * ▼

End IP Address *

Default Gateway

Lease Time *
 86400
10 - 604800 sec

DNS Server 1 DNS Server 2

NTP Server

Cancel Create

NOTE Users can only create one IP pool. It can be connected to different network subnets with the Management IP of the switch.

Enable

Setting	Description	Factory Default
Enabled	Enables the DHCP server pool.	Enabled
Disable	Disables the DHCP server pool.	

Start IP Address

Setting	Description	Factory Default
Input the first IP address	Specify the first IP address for the pool.	None

Subnet Mask

Setting	Description	Factory Default
Select from the drop-down list	Specify the subnet mask for the pool.	None

End IP Address

Setting	Description	Factory Default
Input the last IP address	Specify the last IP address for the pool.	None

Default Gateway

Setting	Description	Factory Default
Input the IP address of the default gateway	Specify the default gateway for clients to use.	None

Lease Time (sec.)

Setting	Description	Factory Default
Input the lease time for the DHCP, from 10 to 604,800 seconds (up to 7 days)	Specify the lease time for DHCP IP assignments.	86400

DNS Server 1

Setting	Description	Factory Default
Input the IP address of the 1 st DNS server	Specify the IP address of the 1 st DNS server for clients to use.	None

DNS Server 2

Setting	Description	Factory Default
Input the IP address of the 2 nd DNS server	Specify the IP address of the 2 nd DNS server for clients to use.	None

NTP Server

Setting	Description	Factory Default
Input the address of the NTP server	Specify the NTP server clients will use.	None

When finished, click **Create**.

MAC-based IP Assignment

Users can assign an IP address for a specific MAC address. This can be useful if you always want the same IP address to be assigned to a specific device, even if it is reconnected or connected to a different port.

Click the **MAC-based IP Assignment** tab, and then click the **+** icon on the configuration page.

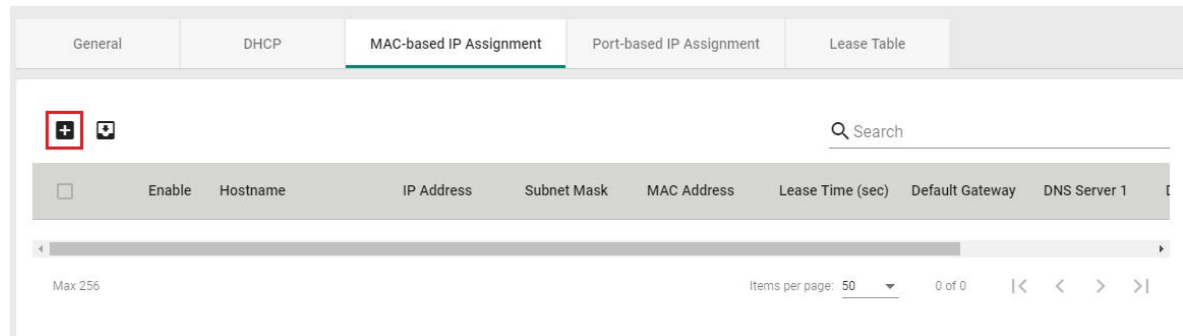

Configure the following parameters.

Create Entry

Enable
 Enabled

Hostname * i
 0 / 63

IP Address * Subnet Mask *

MAC Address *

Default Gateway

Lease Time *
 86400
 10 - 86400 sec

DNS Server 1 DNS Server 2

Cancel
Create

Enable

Setting	Description	Factory Default
Enabled	Enables the MAC-based IP assignment entry.	Enabled
Disabled	Disables the MAC-based IP assignment entry.	

Hostname

Setting	Description	Factory Default
Enter a hostname between 0 and 63 characters	Specify a hostname to use for the DHCP client.	None

IP Address

Setting	Description	Factory Default
Input the assigned IP address	Specify the IP address to assign to the client.	None

Subnet Mask

Setting	Description	Factory Default
Select from the drop-down list	Specify the subnet mask to use for the client.	None

MAC Address

Setting	Description	Factory Default
Input the assigned MAC address	Specify the MAC address of the device you want to assign an IP address to. Make sure the MAC address is entered in the correct format. Here is an example: 28-d2-44-D3-e3-f2 or 28:d2:44:D3:e3:f2.	None

Default Gateway

Setting	Description	Factory Default
Input the IP address of the default gateway	Specify the default gateway for the client to use.	None

Lease Time (sec.)

Setting	Description	Factory Default
Input the lease time for the DHCP, from 10 to 604800.	Define how long before the IP address needs to be reassigned.	86400

DNS Server 1

Setting	Description	Factory Default
Input the IP address of the 1 st DNS server	Specify the IP address of the 1 st DNS server for the client to use.	None

DNS Server 2

Setting	Description	Factory Default
Input the IP address of the 2 nd DNS server	Specify the IP address of the 2 nd DNS server for the client to use.	None

NTP Server

Setting	Description	Factory Default
Input the address of the NTP server	Specify the NTP server the client will use.	None

When finished, click **Create**.

Port-based IP Assignment

Users can assign an IP to a device based on what switch port it is connected to. This can be useful if you want to always use the same IP for a device connected to a specific port, even if it is replaced with a different device.

On the **General** tab, select **Port-based IP Assignment**. Click **Apply**.

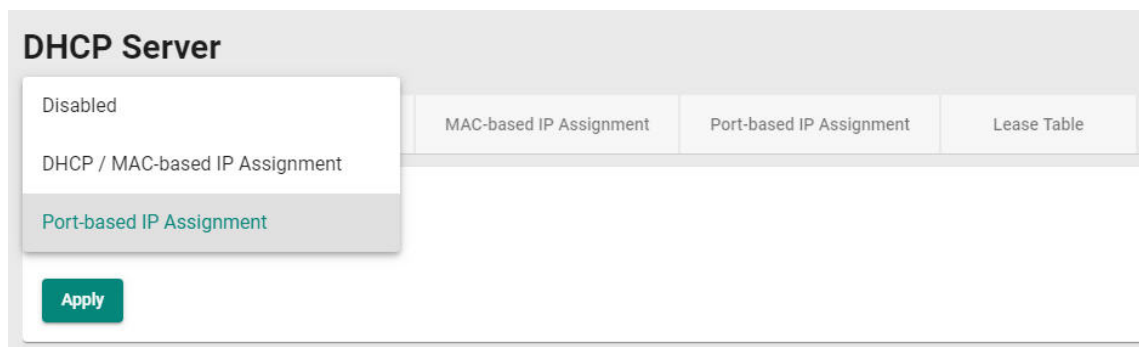

Next, click the **Port-based IP Assignment** tab, and then click the **+** icon on the configuration page.

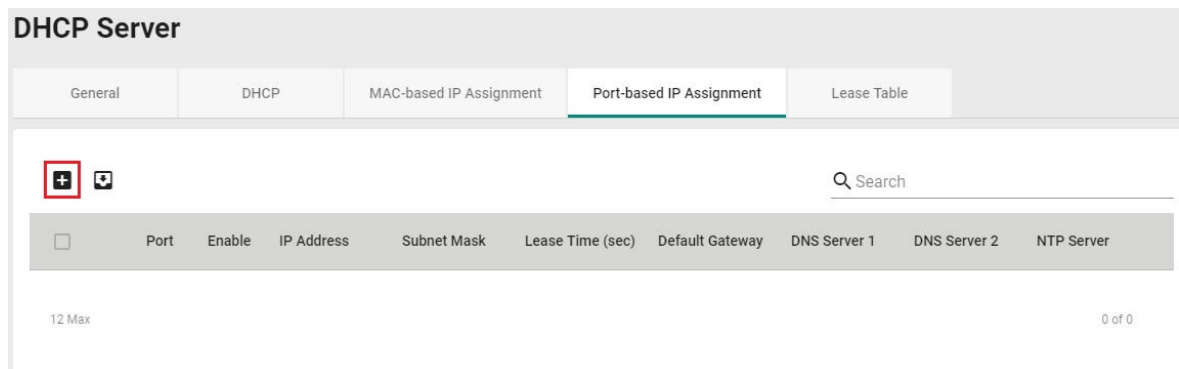

Configure the following parameters.

Create Entry

Enable
 Enabled ▼

Port * ▼

IP Address * Subnet Mask * ▼

Default Gateway

Lease Time *
 86400
10 - 604800

DNS Server 1 DNS Server 2

NTP Server

Cancel
Create

Enable

Setting	Description	Factory Default
Enabled	Enables the port-based IP assignment entry.	Enabled
Disabled	Disables the port-based IP assignment entry.	

Port

Setting	Description	Factory Default
Select from 1 to 28	Select which switch port the DHCP server will assign an IP address for.	None

IP Address

Setting	Description	Factory Default
Input the assigned IP address	Specify the IP address to assign to the client.	None

Subnet Mask

Setting	Description	Factory Default
Select from the drop-down list	Specify the subnet mask to use for the client.	None

Default Gateway

Setting	Description	Factory Default
Input the IP address of the default gateway	Specify the default gateway for the client to use.	None

Lease Time (sec.)

Setting	Description	Factory Default
Input the lease time for the DHCP, from 10 to 604800	Define how long before the IP address needs to be reassigned.	86400

DNS Server 1

Setting	Description	Factory Default
Input the IP address of the 1 st DNS server	Specify the IP address of the 1 st DNS server for the client to use.	None

DNS Server 2

Setting	Description	Factory Default
Input the IP address of the 2 nd DNS server	Specify the IP address of the 2 nd DNS server for the client to use.	None

NTP Server

Setting	Description	Factory Default
Input the address of the NTP server	Specify the NTP server the client will use.	None

When finished, click **Create**.

Lease Table

Click **Lease Table** to view detailed information for the hostname, IP address, MAC address, and time left for each port.

DHCP Server

General
DHCP
MAC-based IP Assignment
Port-based IP Assignment
Lease Table

↻
+
Search

Hostname	IP Address	MAC Address	Time Left
CINDY-YANG01	192.168.127.1	c8:cb:b8:02:26:5f	23 h: 57 m: 41 s

Item	Description
Hostname	The hostname of the client.
IP Address	The IP address of the client.
MAC Address	The MAC address of the client.
Time Left	The amount of time left on the DHCP lease for the client.

Time

This section describes how to configure the **Time Zone** and **System Time** settings for the switch. The switch has a time calibration function based on information from an NTP server or a user-specified time and date, allowing functions such as automatic warning emails to include a time and date stamp.

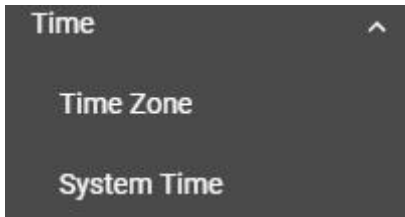

NOTE The user must update the Current Time and Current Date after the switch has been powered off for an extended period of time (e.g., three days). The user must pay particular attention to this when there is no NTP server or Internet connection available.

Time Zone

Users can configure the time zone for the switch.

Time Zone

System Uptime
0d3h30m56s

Current Time
Fri Dec 21 2018 22:24:24 UTC+00:00

Time Zone
UTC+00:00

Daylight Saving
Disabled

Start Date * Start Time *
1/9/2020 04:33 PM

End Date * End Time *
1/9/2020 04:33 PM

Offset
00:00

Apply

System Uptime

Setting	Description	Factory Default
System-specified time	This indicates how long the switch has been running since the last cold start.	N/A

Current Time

Setting	Description	Factory Default
User-specified time	Shows the current system time.	None

Time Zone

Setting	Description	Factory Default
Select from the drop-down list	Specify the time zone to use for the switch.	GMT (Greenwich Mean Time)

Daylight Saving Time

The Daylight Saving Time settings are used to automatically adjust the time according to regional standards.

Daylight Saving
 Enabled 

Start Date *  5/16/2019

Start Time *  08:20 PM

End Date *  5/16/2019

End Time *  08:20 PM

Offset
 00:00

Apply

Configure the following settings.

Daylight Saving Time

Setting	Description	Factory Default
Enabled	Enables Daylight Saving Time.	Disabled
Disabled	Disables Daylight Saving Time.	

Start Date

Setting	Description	Factory Default
User-specified date	Specify the date that Daylight Saving Time begins.	None

End Date

Setting	Description	Factory Default
User-specified date	Specify the date that Daylight Saving Time ends.	None

Offset

Setting	Description	Factory Default
User-specified hour	Specify the offset (in HH:MM format) to use during Daylight Saving Time.	None

When finished, click **Apply** to activate the time zone settings.

System Time

This section describes how to configure the time, NTP server, and NTP authentication settings.

Time

The section describes how to configure the system time. Click the **Time** tab.

System Time

Time
NTP Server
NTP Authentication

Current Time
Thu May 16 2019 20:24:3

Clock Source
Local

Date *
5/16/2019

Time
08:24 PM

Apply
Sync From Browser
Refresh

Current Time

Setting	Description	Factory Default
None	This automatically shows the current time according to your default settings.	Local

Clock Source

Setting	Description	Factory Default
Select from the drop-down list	Specify whether to set the time manually (Local), from an SNTP server, or from an NTP server.	Local

Clock Source is from Local

Date

Setting	Description	Factory Default
Select the date	Select the current date.	Local

MAY 2019 < >

S	M	T	W	T	F	S
			1	2	3	4
5	6	7	8	9	10	11
12	13	14	15	16	17	18
19	20	21	22	23	24	25
26	27	28	29	30	31	

Time

Setting	Description	Factory Default
Input the current time	Specify the current time. You can manually input the time, or you can click Sync From Browser to set the time based on the time used by your web browser.	None

Clock Source is from SNTP

Time Server 1

Setting	Description	Factory Default
Input the address of the 1 st SNTP time server	Specify the IP or domain address of the 1 st SNTP server to use (e.g., 192.168.1.1, time.stdtime.gov.tw, or time.nist.gov).	Time.nist.gov

Time Server 2

Setting	Description	Factory Default
Input the address of the 2 nd SNTP time server	Specify the IP or domain address of the secondary SNTP server to use if the first SNTP server fails to connect.	None

Click **Apply** to complete.

Clock Source is from NTP

If the switch is connecting to an NTP server that requires authentication, refer to the **NTP Authentication** section to configure the NTP key to use.

Time Server 1

Setting	Description	Factory Default
Input the address of the 1 st NTP time server	Specify the IP or domain address of the 1 st NTP server to use (e.g., 192.168.1.1, time.stdtime.gov.tw, or time.nist.gov).	Time.nist.gov

Authentication

Setting	Description	Factory Default
Disabled	Enable or disable NTP authentication for Time Server 1.	Disabled

Time Server 2

Setting	Description	Factory Default
Input the address of the 2 nd time server	Specify the IP or domain address of the secondary NTP server to use if the first NTP server fails to connect.	None

Authentication

Setting	Description	Factory Default
Disabled	Enable or disable NTP Authentication for Time Server 2.	Disabled

Click **Apply** to complete.

NTP Server

Click the **NTP Server** Tab to perform further configuration.

The screenshot shows the 'System Time' configuration page. At the top, there are three tabs: 'Time', 'NTP Server', and 'NTP Authentication'. The 'NTP Server' tab is selected and highlighted with a green underline. Below the tabs, there are two dropdown menus. The first is labeled 'NTP Server' and is currently set to 'Disabled'. The second is labeled 'Client Authentication' and is also set to 'Disabled'. At the bottom left of the configuration area, there is a green 'Apply' button.

Enable

Setting	Description	Factory Default
Enabled	Enable the NTP server.	Disabled
Disabled	Disable the NTP server.	

Client Authentication

Setting	Description	Factory Default
Enabled	Enable NTP authentication.	Disabled
Disabled	Disable NTP authentication.	

When finished, click **Apply** to save your changes.

NTP Authentication

This section describes how to configure NTP Authentication. Click the **NTP Authentication** tab, and then click the + icon on the page.

The screenshot shows the 'System Time' configuration page with the 'NTP Authentication' tab selected and highlighted with a green underline. In the main configuration area, a red square box highlights a plus sign icon (+) in the top left corner. Below this icon is a table header with three columns: 'Key ID', 'Type', and 'Key String'. The first cell of the table contains a small square icon.

Configure the following settings.

Create Entry

Key ID

Type

Key String *

0 / 32

Cancel

Key ID

Setting	Description	Factory Default
Input the Key ID from 1 to 10	Input the Key ID to use for NTP authentication.	None

Type

Setting	Description	Factory Default
Input the authentication type	Input the authentication type.	MD5

Key String

Setting	Description	Factory Default
Input the key string for authentication, from 0 to 32 characters.	Input the password to use for the authentication key.	None

When finished, click **Create**.

Port

This section describes how to configure the **Port Interface**, **Link Aggregation**, and **PoE** functions for the switch.



Port Interface



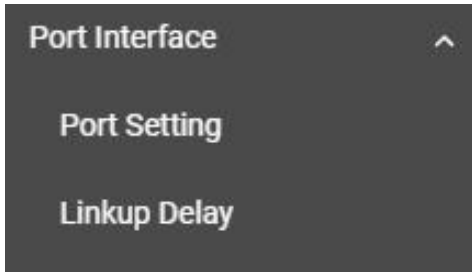

Two functions are included in this section: **Port Setting** and **Linkup Delay**.



Port Setting

Under **Port Setting**, select the **Setting** tab and then click the edit icon on the port you want to configure.

The screenshot shows the 'Port Setting' web interface. At the top, there are two tabs: 'Setting' (highlighted with a red box) and 'Status'. Below the tabs is a search bar with a magnifying glass icon and the text 'Search'. A table lists four ports with columns for Port, Admin Status, Media Type, Description, Speed/Duplex, Flow Control, and MDI/MDIX. The first row (port 1/1) has a pencil icon in the first column, which is highlighted with a red box.

Port	Admin Status	Media Type	Description	Speed/Duplex	Flow Control	MDI/MDIX
 1/1	Enabled	1000TX,RJ45,PTP		Auto	Disabled	Auto
 1/2	Enabled	1000TX,RJ45,PTP		Auto	Disabled	Auto
 1/3	Enabled	1000TX,RJ45,PTP		Auto	Disabled	Auto
 1/4	Enabled	1000TX,RJ45,PTP		Auto	Disabled	Auto

Configure the following parameters.

Edit Port 1/1 Setting

Admin Status
 Enabled ▼

Media Type
 1000TX,RJ45,PTP

Description

Speed/Duplex
 Auto ▼

Flow Control
 Disabled ▼ i

MDI/MDIX
 Auto ▼

Copy Config to Ports ▼ i

Cancel
Apply

Admin Status

Setting	Description	Factory Default
Enable	Allows data transmission through this port.	Enabled
Disabled	Disables data transmission through this port.	

Media Type

Setting	Description	Factory Default
Media type	Displays the media type for each module’s port.	1000TX,RJ45,PTP

Description

Setting	Description	Factory Default
Max. 63 characters	Specify an alias for the port to help differentiate between different ports (e.g., PLC1).	None

Speed/Duplex

Setting	Description	Factory Default
Auto	Allows the port to use the IEEE 802.3u protocol to negotiate with connected devices. The port and connected devices will determine the best speed for that connection. Choose a fixed speed option if the connected Ethernet device has trouble auto-negotiating line speed.	Auto
10M Half		
10M Full		
100M Half		
100M Full		
1G Full		

Flow Control

This setting enables or disables flow control for the port when the port’s speed is set to Auto. The final result will be determined by the Auto process between the switch and connected devices.

Setting	Description	Factory Default
Enable	Enables flow control for this port when the port’s speed is set to Auto.	Disabled
Disable	Disables flow control for this port when the port’s speed is set to Auto.	

MDI/MDIX

Setting	Description	Factory Default
Auto	Allows the port to auto-detect the port type of the connected Ethernet device, and changes the port type accordingly.	Auto
MDI	Choose MDI or MDIX if the connected Ethernet device has trouble auto-detecting the port type.	
MDIX		

Copy Config to Ports

Setting	Description	Factory Default
Select the port(s) from the drop-down list	Allows you to copy the configuration to other port(s).	None

When finished, click **Apply** to save your changes.

Port Status

To view the status of the ports, click the **Status** tab.

Port Setting

Setting

Status

↻ ⌵

Port	Admin Status	Media Type	Link Status	Description	Flow Control	MDI/MDIX	Port State
1/1	Enabled	1000TX,RJ45,PTP	1G, Full (Auto)		Disabled	MDI(Auto)	Forwarding
1/2	Enabled	1000TX,RJ45,PTP	Link Down		Disabled	Invalid	Blocking
1/3	Enabled	1000TX,RJ45,PTP	Link Down		Disabled	Invalid	Blocking
1/4	Enabled	1000TX,RJ45,PTP	Link Down		Disabled	Invalid	Blocking

Linkup Delay

Linkup Delay Overview

Linkup delay is used to prevent a port alternating between link up and link down. It is also sometimes called link flap prevention. This feature is useful when the link connection is unstable. An unstable connection might be caused by a faulty cable, faulty fiber transceiver, duplex mismatch, etc. This feature helps administrators to mitigate the risk of an unstable network, particularly when the topology changes frequently.

Linkup Delay Settings

This section describes how to configure the linkup delay for the ports. Click the **Linkup Delay** menu. The default value is disabled, which means linkup delay is disabled for all ports.

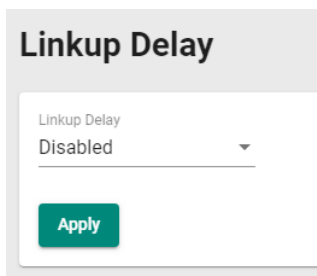





Enable

Setting	Description	Factory Default
Enable	Enables linkup delay.	Disabled
Disabled	Disables linkup delay.	

When finished, click **Apply** to save your changes.

To configure linkup delay for a port, click the edit icon on the port you want to configure.

	Port	Enable	Delay Time	Remaining Time
	1/1	Disabled	2	0
	1/2	Disabled	2	0
	1/3	Disabled	2	0
	1/4	Disabled	2	0

Some parameters need to be configured.

Edit Port 1/1 Setting

Linkup Delay
 Disabled ▼

Delay Time *
 2

1 - 1000 sec

Copy Config to Ports ▼ i

Cancel

Apply

Linkup Delay

Setting	Description	Factory Default
Enable	Enables linkup delay for the port.	Disabled
Disable	Disables linkup delay for the port.	

Delay Time (sec.)

Setting	Description	Factory Default
1 to 1000	Specify the linkup delay time from 1 to 1000 seconds.	2

Copy Config to Ports

Setting	Description	Factory Default
Select the port(s) from the drop-down list	Allows you to copy the configurations to other port(s).	None

When finished, click **Apply** to save your changes.

Link Aggregation

Link Aggregation (Port Channel) Overview

Link Aggregation helps balance, optimize, and facilitate the switch's throughput. This method can combine multiple network communications in parallel to maximize data throughput, increasing data communication efficiency for each port. In addition, it also acts as a useful method for network redundancy when a link fails. In general, Link Aggregation supports combining multiple physical switch ports into a single, efficient bandwidth data communication route. This can improve network load sharing and increase network reliability.

Static Trunk

For some networking applications, a situation can arise where traffic from multiple ports is required to be filtered through one port. For example, if there are 30 UHD IP surveillance cameras deployed and connected in a ring, the traffic can reach up to 1 Gbps, causing a surge in traffic that can increase network loading by up to 50%. Hence, the uplink port needs to use the static trunk function to provide more bandwidth and redundancy protection.

LACP

The Link Aggregation Control Protocol (LACP) allows a network device to negotiate an automatic bundling of several ports by sending LACP packets to the peer, a directly connected device that also uses LACP.

Algorithm

In Link Aggregation, three load-sharing hash algorithms can be used: **SMAC**, **DMAC**, and **SMAC + DMAC**.

SMAC: SMAC stands for **Source MAC**, often used as a tool to optimize algorithm parameters. It is also an algorithm to evaluate the most efficient network data communication. SMAC is used for many different client situations.

DMAC: DMAC stands for **Destination MAC**. The packets will be distributed and transmitted to the destination MAC address hash algorithm, and is usually used in many different destination servers situation.

SMAC + DMAC: This can be used for more complex hash algorithm, but where the network just has a few clients and servers.

Link Aggregation Settings

This section describes how to configure link aggregation for each port. Click **Link Aggregation** on the menu and then click the + icon on the configuration page.

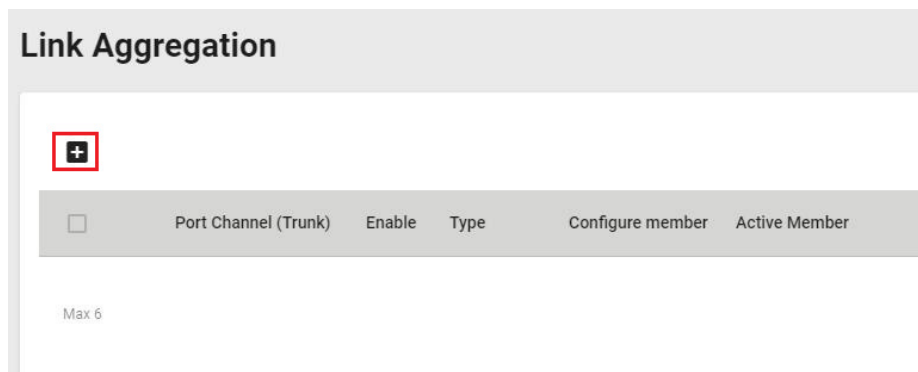

To create a link aggregation group, configure the following parameters.

Create Link Aggregation

LA Group Status
 Enabled ▼

Type * ▼

Config Member Port * ▼ i

Algorithm *
 SMAC + DMAC ▼

Cancel

Create

LA Group Status

Setting	Description	Factory Default
Enable	Enable link aggregation grouping.	None
Disable	Disable link aggregation grouping.	

Type

Setting	Description	Factory Default
Manual	Configure the link aggregation type manually.	None
LACP	Configure the link aggregation type by LACP.	

Config Member Port

Setting	Description	Factory Default
Select from the ports	Select the ports you want to create for link aggregation grouping.	None

Algorithm (in Advanced Mode only)

Setting	Description	Factory Default
SMAC	Use SMAC as algorithm configuration.	SMAC + DMAC
DMAC	Use DMAC as the algorithm configuration.	
SMAC + DMAC	Use both SMAC and DMAC as the algorithm configuration.	

When finished, click **Create** to continue.

You can view the current Link Aggregation or Port Channel (Trunk) status on the configuration page. You can also edit or delete by clicking the edit or delete icon on the page.

+
Q Search

<input type="checkbox"/>	Port Channel (Trunk)	Enable	Type	Configure member	Active Member
<input type="checkbox"/>	1	Enabled	Manual	1/1, 1/2	

Editing Port Setting for Link Aggregation

To edit each port's setting for Link Aggregation, click the edit icon on the port name. You can also check the port and then click the edit icon for editing the port settings for Link Aggregation.

+
Q Search

<input type="checkbox"/>	Port Channel (Trunk)	Enable	Type	Algorithm	Configure member	Active Member
<input type="checkbox"/>	1	Enabled	LACP	SMAC + DMAC	1/2	

Edit the following port settings.

Edit Port Channel 1 Setting

LA Group Status
 Enabled ▼

Type *
 Manual ▼

Config Member Port *
 1/1, 1/2 ▼ i

Cancel
Apply

LA Group Status

Setting	Description	Factory Default
Enable	Enable link aggregation grouping.	None
Disable	Disable link aggregation grouping.	

Type

Setting	Description	Factory Default
Manual	Configure link aggregation manually.	None
LACP	Configure link aggregation by LACP.	

Config Member Port

Setting	Description	Factory Default
Select from the ports	Select the ports you want to create link aggregation grouping for.	None

When finished, click **Apply** to save your changes.

Deleting the Port for Link Aggregation

To delete the port for Link Aggregation, check the port and then click the delete icon.

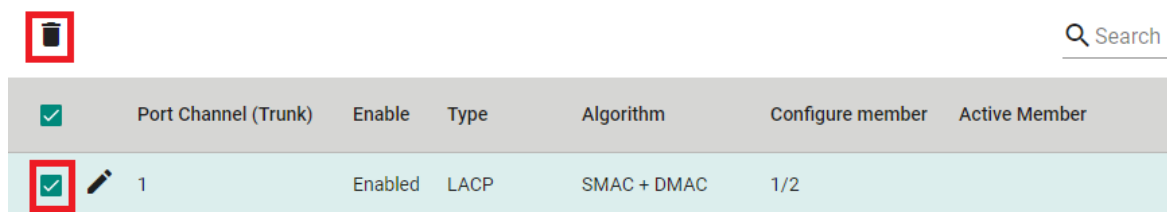

Click **Delete** to finish. Note that some features, such as RSTP and VLAN will be set to default values once you delete the Link Aggregation setting.

Delete Link Aggregation

Warning:
Some features (like RSTP, VLAN...etc.) related to selected Link Aggregation will be set to default values.

Are you sure you want to delete the selected Link Aggregation?



PoE

PoE Overview

Power over Ethernet (PoE) has become increasingly popular, due in large part to the reliability provided by PoE Ethernet switches that supply the power to Powered Devices (PD) when AC power is not available or is too expensive to provide locally.

Power over Ethernet can be used with the following types of devices:

- Surveillance cameras
- Security I/O sensors
- Industrial wireless access points
- Emergency IP phones

Recently, more data, video, voice, service, and control packets are converging on one network. Moxa’s PoE switches are equipped with many advanced PoE management functions, providing critical security systems with a convenient and reliable Ethernet network. Moreover, Moxa’s advanced PoE switches support the high power PoE+ standard, PD failure check, legacy PD detection, and auto power cutting.

PoE Port Settings

Click **PoE** on the menu, and then select the **General** tab on the configuration page.

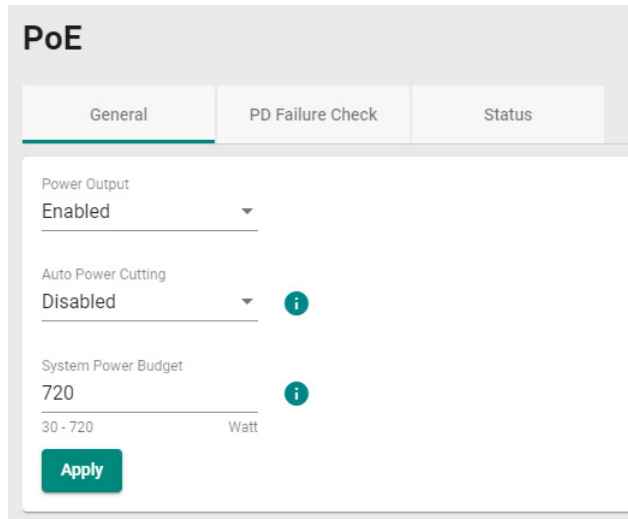

Configure the following settings.

Power Output

Setting	Description	Factory Default
Enable	Enable PoE for all ports on the switch.	Enabled
Disable	Disable PoE for all ports on the switch.	

Auto Power Cutting

Setting	Description	Factory Default
Enable	If the total power consumption exceeds the system power budget threshold, low priority for power output of the port will perform auto power cutting.	Disabled
Disable	Disable the system power budget criteria design.	

System Power Budget (watt)





Setting	Description	Factory Default
Input the value from 30 to 720	Input a value for the system power budget.	720

When finished, click **Apply** to save your changes.

Editing PoE Settings for Each Port

In this section, you can also enable the PoE function for specific ports even when the system PoE is disabled under the General tab.

To edit the PoE settings for a port, click the edit icon for that port.

Port	PoE Supported	Power Output	Output Mode	Power Allocation	Legacy PD Detection	Priority
 1/1	No	Enabled	Auto	0	Disabled	Low
 1/2	No	Enabled	Auto	0	Disabled	Low
 1/3	No	Enabled	Auto	0	Disabled	Low
 1/4	No	Enabled	Auto	0	Disabled	Low

Edit Port 1/1 Setting

Power Output
 Enabled ▼

Output Mode ▼ Legacy PD Detection
 Auto ▼ Disabled ▼

Power Allocation
 0
 0 - 36 Watt

Priority
 Low ▼

Copy Config to Ports ▼ 

Cancel

Apply

Edit the following parameters.

Power Output

Setting	Description	Factory Default
Enable	Enable PoE for this port.	Enabled
Disable	Disable PoE for this port.	

Output Mode

Setting	Description	Factory Default
Auto	Auto mode follows the 802.3af/at standard, which means the power allocation value cannot be changed manually.	Auto
High Power	High Power mode follows the 802.3at standard, but High Power mode allocates 36 watts of power to the PD if it requires more than 30 watts of power.	
Force	Provides power output to non-802.3 af/at PDs when the detected PD has higher/lower resistance or higher capacitance and the acceptable PD resistance range exceeds 2.4 kΩ. The system will prompt you to select Force Mode to allocate 0 to 36 watts of power.	

Legacy PD Detection

The PoE Ethernet Switch includes a Legacy PD Detection function. When the capacitance of the PD is higher than 2.7 μ F and less than 10 μ F, enabling the Legacy PD Detection will trigger the system to output power to the PD. In this case, it will take a few seconds for PoE power to be output through this port after the switch Legacy PD Detection is enabled.

Setting	Description	Factory Default
Enable	Enable legacy PD detection.	Disabled
Disable	Disable legacy PD detection.	

Power Allocation (watt)

Setting	Description	Factory Default
0	When the output mode is Auto, the value is fixed as 0.	0
36	When the output mode is High Power, the value is fixed as 36.	36
0 to 36	When the output mode is set to Force, input a value from 0 to 36.	36

Priority

Use **Power Priority** when managing PoE power with measured power mode. You can choose one of the following settings: critical, high, or low. When the PoE measured power exceeds the assigned limit, the switch will disable the PoE port with the lowest priority.

Setting	Description	Factory Default
Critical	Configure the port as critical (highest) priority.	Low
High	Configure the port as high priority.	
Low	Configure the port as low priority.	

Copy Config to Ports

Setting	Description	Factory Default
Select the port(s) from the drop-down list	Allows you to copy the configurations to other port(s).	None

When finished, click **Apply** to save your changes.

PD Failure Check

The PoE Ethernet switch can monitor the status of a PD via its IP address. If the PD fails, the switch will not receive a PD response after the defined period, and the authentication process will be restarted. This function is extremely useful for ensuring your network’s reliability and reducing your management burden.

Select the **PD Failure Check** tab, and then click the edit icon on the port you want to configure.

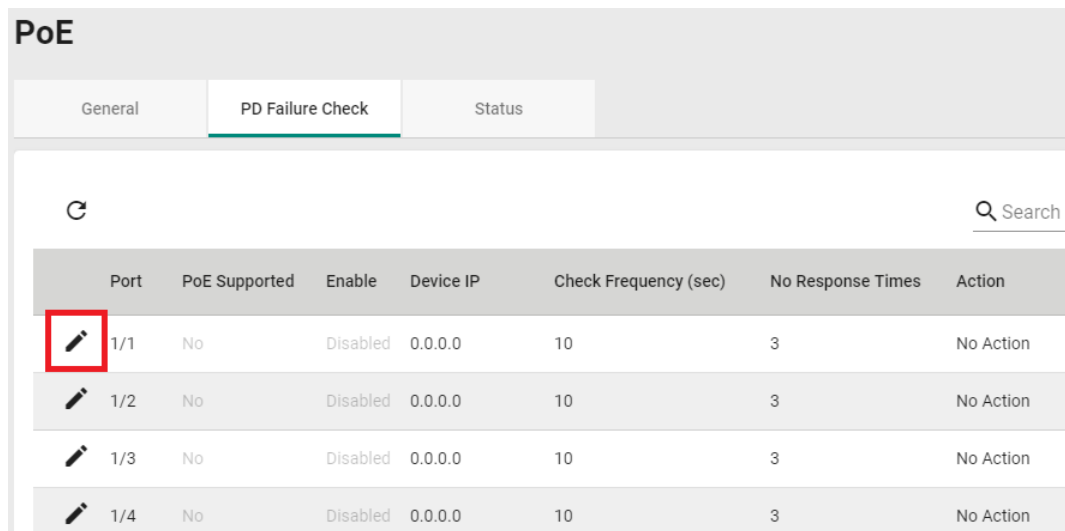

Configure the following parameters.

Edit Port 1/1 Setting

Enable
 Disabled ▼

Device IP *
 0.0.0.0

Check Frequency *	No Response Times *
10	3
5 - 300 sec	1 - 10 times

Action
 No Action ▼

Copy Config to Ports ▼ i

Cancel Apply

Enable

Setting	Description	Factory Default
Enable	Enable PD failure check for this port.	Disabled
Disable	Disable PD failure check for this port.	

Device IP

Setting	Description	Factory Default
Input the device's IP	Specify the PD's IP address.	0.0.0.0

Check Frequency (sec.)

Setting	Description	Factory Default
5 to 300	Specify how often the PD failure check will run.	10

No Response Times

Setting	Description	Factory Default
1 to 10	The maximum number of IP checking cycles.	3

Action

Setting	Description	Factory Default
No Action	No action will run.	No Action
Restart PD	Restart the PoE device when settings are triggered.	
Shutdown PD	Shut down the PoE device when settings are triggered.	

Copy Config to Ports

Setting	Description	Factory Default
Select the port(s) from the drop-down list	Copy the configurations to other port(s).	None

When finished, click **Apply** to save your changes.

PoE Scheduling

Note that this function is only available in **Advanced Mode**.

Powered devices might not need to be running 24 hours a day, 7 days a week. The PoE Ethernet switch includes a PoE scheduling mechanism that allows users to economize the system’s power burden by setting a flexible working schedule for each PoE port. Switch to **Advanced Mode**, click the **Scheduling** tab, and then click the **+** icon to create the scheduling settings.

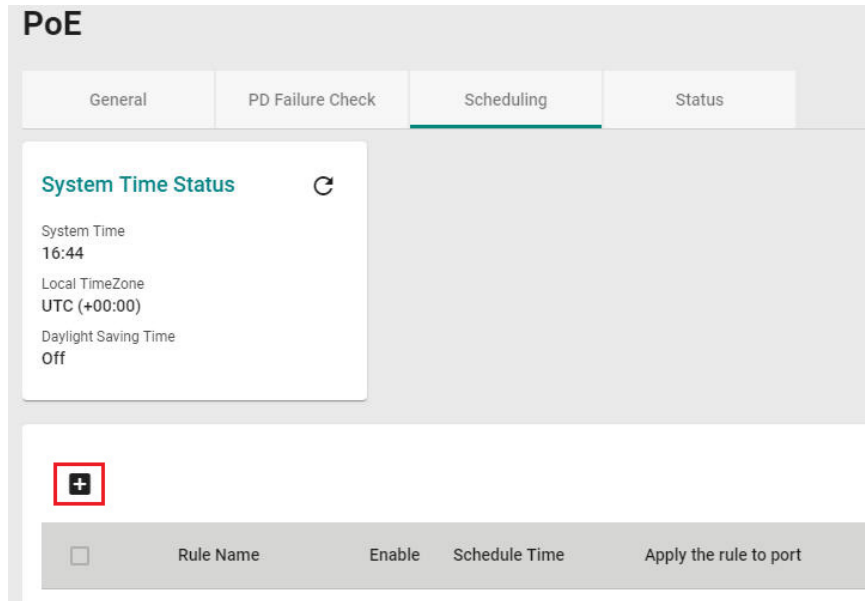

Edit the following parameters.

Create Rule

Rule Name *

Enable

Enabled ▾

Start Date *

Start Time * End Time *

--:-- -- --:-- --

Repeat Execution * ▾

Apply the rule to port * ▾

Cancel Create

Rule Name

Setting	Description	Factory Default
Input the rule name	Input the name for the scheduling rule.	None

Enable

Setting	Description	Factory Default
Enable	Enable PoE Scheduling for this port.	Disabled
Disable	Disable PoE Scheduling for this port.	

Start Date

Setting	Description	Factory Default
Input start date in the mm/dd/yyyy format	Input the start date for the rule.	None

Start Time

Setting	Description	Factory Default
Select the start time in AM/PM hh/mm format	Select the start time for the rule.	None

End Time

Setting	Description	Factory Default
Select the end time in AM/PM hh/mm format	Select the end time for the rule.	None

Repeat Execution

Setting	Description	Factory Default
None	Do not repeat the rule.	None
Daily	Execute the rule every day.	
Weekly	Execute the rule every week.	

Apply the rule to port

Setting	Description	Factory Default
Select the port(s) from the drop-down list	Copy the settings to the port(s) you want to have the same rule.	None

When finished, click **Create**. You can check the PoE Scheduling settings in the following figure.

	Edit	Delete	Rule Name	Enable	Schedule Time	Apply the rule to port
			one	Enabled	01:00 - 02:00, Daily	1/1, 1/2

PoE Status

You can view the current PoE setting status by clicking the **Status** tab.

You can view the PoE status for each port. Refer to the following descriptions.

Name	Description
Port	PoE port on the device.
PoE Supported	Check if this port supports PoE.
Power Output	Power output status (on/off) for the port.
Classification	Check the Classification table below for details.
Current (mA)	The current (mA) that the port supplies.
Voltage (V)	The voltage (V) that the port supplies.
Consumption (W)	The power consumption that the device consumes.
Device Type	Check the Device Type table below for details.
Configuration Suggestion	Refer to the Configuration Suggestion table below for details.
PD Failure Check	Disable/Alive/Not Alive.

Classification

Classification	Max Power (watt) by PSE Output
0	15.4
1	4
2	7
3	15.4
4 (802.3at Type 2)	30
4 (802.3at)	30

Device Type

Item	Description
Not Present	No connection to the port.
Legacy PoE Device	A legacy PD is connected to the port, and the PD has detected that the voltage is too low or high, or the PD’s detected capacitance is too high.
IEEE 802.3af	An IEEE 802.3af PD is connected to the port.
IEEE 802.3at	An IEEE 802.3at PD is connected to the port.
NIC	A NIC is connected to the port.
Unknown	An unknown PD is connected to the port.
N/A	The PoE function is disabled.

Configuration Suggestion

Item	Description
Disable PoE power output	When detecting a NIC or unknown PD, the system suggests disabling PoE power output.
Enable "Legacy PD Detection"	When detecting a higher capacitance of PD, the system suggests enabling Legacy PD Detection.
Select Force Mode	When detecting higher/lower resistance or higher capacitance, the system suggests selecting Force Mode.
Select IEEE 802.3af/at auto mode	When detecting an IEEE 802.3 af/at PD, the system suggests selecting 802.3 af/at Auto mode.
Select high power output	When detecting an unknown classification, the system suggests selecting High Power output.
Raise the external power supply voltage to greater than 46 VDC	When the external supply voltage is detected at less than 46 V, the system suggests raising the voltage.
Enable PoE function for detection	The system suggests enabling the PoE function.

Layer 2 Switching

This section describes how to configure various parameters, such as **VLAN**, **GARP**, **MAC**, **QoS**, and **Multicast**, for Moxa's switch. Click **Lay 2 Switching** on the function menu.

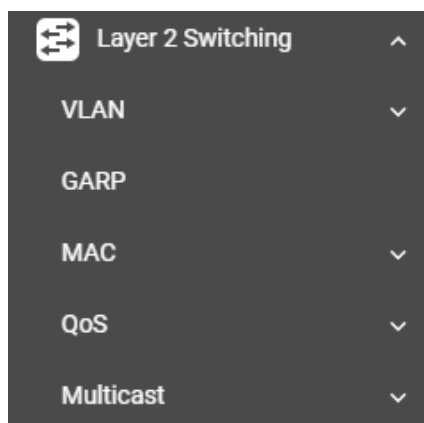

VLAN

This section includes **IEEE802.1Q** and **GARP** configurations.

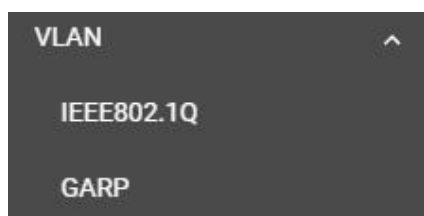

IEEE 802.1Q Overview

The IEEE 802.1Q is a network communication protocol that falls under the IEEE 802.1 standard regulation, allowing various segments to use a physical network at the same time to block broadcast packets by different segmentations. It specifies the VLAN tagging for Ethernet frames on switches that can control the path process.

How A VLAN Works

What is a VLAN?

A VLAN is a group of devices that can be located anywhere on a network, but which communicate as if they are on the same physical segment. With VLANs, you can segment your network without being restricted by physical connections—a limitation of traditional network design. With VLANs you can segment your network into:

- **Departmental groups**—You could have one VLAN for the marketing department, another for the finance department, and another for the product development department.
- **Hierarchical groups**—You could have one VLAN for directors, another for managers, and another for general staff.
- **Usage groups**—You could have one VLAN for email users and another for multimedia users.

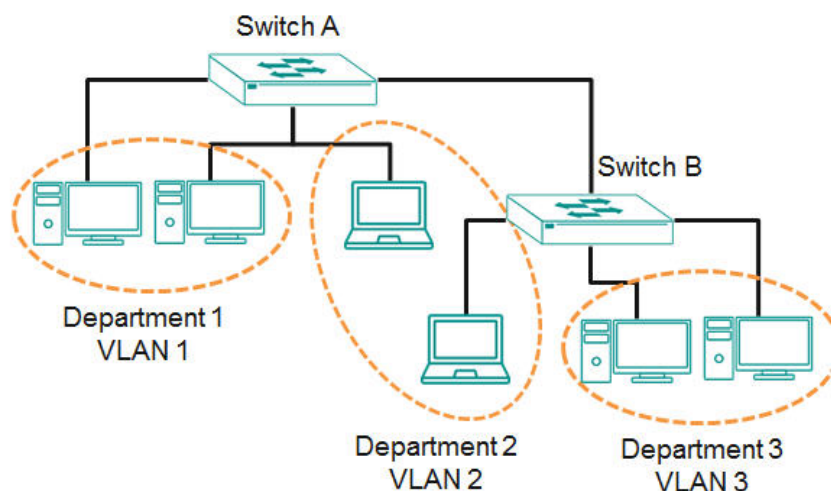

Benefits of VLANs

The main benefit of VLANs is that they provide a network segmentation system that is far more flexible than traditional networks. Using VLANs also provides you with three other benefits:

- **VLANs ease the relocation of devices on networks:** With traditional networks, network administrators spend much of their time dealing with changes. If users move to a different subnetwork, the addresses of each host must be updated manually. With a VLAN setup, if a host originally on the Marketing VLAN is moved to a port on another part of the network, and retains its original subnet membership, you only need to specify that the new port is on the Marketing VLAN. You do not need to do any re-cabling.
- **VLANs provide extra security:** Devices within each VLAN can only communicate with other devices on the same VLAN. If a device on the Marketing VLAN needs to communicate with devices on the Finance VLAN, the traffic must pass through a routing device or Layer 3 switch.
- **VLANs help control traffic:** With traditional networks, congestion can be caused by broadcast traffic that is directed to all network devices, regardless of whether or not they need it. VLANs increase the efficiency of your network because each VLAN can be set up to contain only those devices that need to communicate with each other.

VLANs and the Moxa switch

Your Moxa switch includes support for VLANs using IEEE Std 802.1Q-2005. This standard allows traffic from multiple VLANs to be carried across one physical link. The IEEE Std 802.1Q-2005 standard allows each port on your Moxa switch to be placed as follows:

- On a single VLAN defined in the switch
- On several VLANs simultaneously using 802.1Q tagging

The standard requires that you define the *802.1Q VLAN ID* for each VLAN on your Moxa switch before the switch can use it to forward traffic:

Managing a VLAN

A new or initialized Moxa switch contains a single VLAN—the Default VLAN. This VLAN has the following definition:

- Management VLAN ID 1 can be changed
- 802.1Q VLAN default ID 1 cannot be deleted

All the ports are initially placed on this VLAN, and it is the only VLAN that allows you to access the management software of the Moxa switch over the network.

Communication Between VLANs

If devices connected to a VLAN need to communicate with devices on a different VLAN, a router or Layer 3 switching device with connections to both VLANs need to be installed. Communication between VLANs can only take place if they are all connected to a routing or Layer 3 switching device.

VLANs: Tagged and Untagged Membership

Moxa's switch supports 802.1Q VLAN tagging, a system that allows traffic for multiple VLANs to be carried on a single physical link (backbone, trunk). When setting up VLANs you need to understand when to use untagged or tagged membership of VLANs. Simply put, if a port is on a single VLAN it can be an untagged member, but if the port needs to be a member of multiple VLANs, a tagged membership must be defined.

A typical host (e.g., clients) will be an untagged member of one VLAN, defined as an **Access Port** in a Moxa switch, while an inter-switch connection will be a tagged member of all VLANs, defined as a **Trunk Port** in a Moxa switch.

The IEEE Std 802.1Q-2005 defines how VLANs operate within an open packet-switched network. An 802.1Q compliant packet carries additional information that allows a switch to determine which VLAN the port belongs to. If a frame is carrying the additional information, it is known as a *tagged* frame.

To carry multiple VLANs across a single physical link (backbone, trunk), each packet must be tagged with a VLAN identifier so that the switches can identify which packets belong to which VLAN. To communicate between VLANs, a router must be used.

Moxa's switch supports three types of VLAN port settings:

- **Access Port:** The port connects to a single device that is not tagged. The user must define the default port PVID that assigns which VLAN the device belongs to. Once the ingress packet of this Access Port egresses to another Trunk Port (the port needs all packets to carry tag information), the switch will insert this PVID into this packet so the next 802.1Q VLAN switch can recognize it.
- **Trunk Port:** The port connects to a LAN that consists of untagged devices and tagged devices. In general, the traffic of the Trunk Port must have a Tag. Users can also assign a PVID to a Trunk Port. The untagged packet on the Trunk Port will be assigned the default port PVID as its VID.
- **Hybrid Port:** The port is similar to a Trunk port, except users can explicitly assign tags to be removed from egress packets.

The following section illustrates how to use these ports to set up different applications.

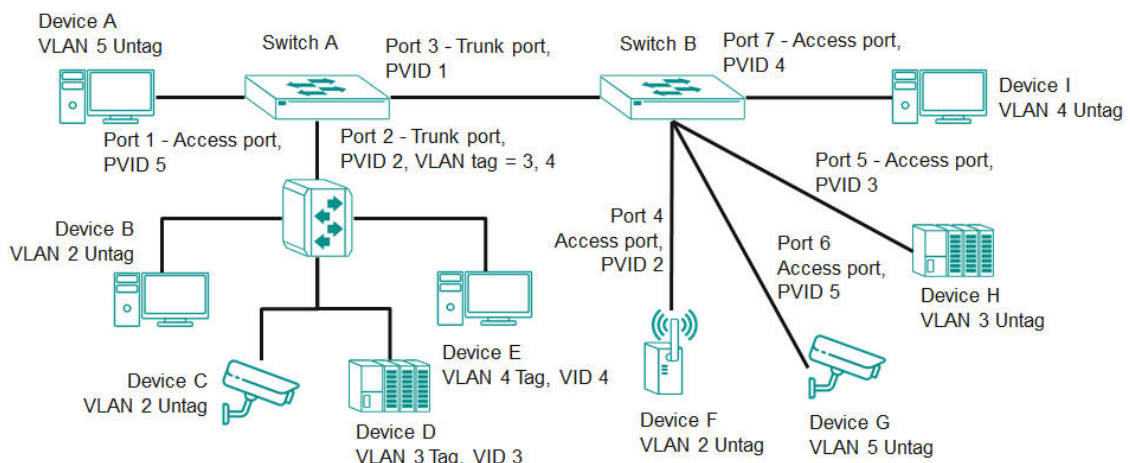

In this application:

- Port 1 connects a single untagged device and assigns it to VLAN 5; it should be configured as an **Access Port** with PVID 5.
- Port 2 connects a LAN with two untagged devices belonging to VLAN 2. One tagged device with VID 3 and one tagged device with VID 4. It should be configured as a **Hybrid Port** with PVID 2 for untagged device and Fixed VLAN (Tagged) with 3 and 4 for tagged device. Since each port can only have one unique PVID, all untagged devices on the same port must belong to the same VLAN.
- Port 3 connects with another switch. It should be configured as a **Trunk Port**. GVRP protocol will be used through the Trunk Port.
- Port 4 connects a single untagged device and assigns it to VLAN 2; it should be configured as an **Access Port** with PVID 2.
- Port 5 connects a single untagged device and assigns it to VLAN 3; it should be configured as an **Access Port** with PVID 3.
- Port 6 connect a single untagged device and assigns it to VLAN 5; it should be configured as an **Access Port** with PVID 5.
- Port 7 connects a single untagged device and assigns it to VLAN 4; it should be configured as an **Access Port** with PVID 4.

After the application is properly configured:

- Packets from Device A will travel through **Trunk Port 3** with tagged VID 5. Switch B will recognize its VLAN, pass it to port 6, and then remove tags received successfully by Device G, and vice versa.
- Packets from Devices B and C will travel through **Hybrid Port 2** with tagged VID 2. Switch B recognizes its VLAN, passes it to port 4, and then removes tags received successfully by Device F, and vice versa.
- Packets from Device D will travel through **Trunk Port 3** with tagged VID 3. Switch B will recognize its VLAN, pass to port 5, and then remove tags received successfully by Device H. Packets from Device H will travel through **Trunk Port 3** with PVID 3. Switch A will recognize its VLAN and pass it to port 2, but will not remove tags received successfully by Device D.
- Packets from Device E will travel through **Trunk Port 3** with tagged VID 4. Switch B will recognize its VLAN, pass it to port 7, and then remove tags received successfully by Device I. Packets from Device I will travel through **Trunk Port 3** with tagged VID 4. Switch A will recognize its VLAN and pass it to port 2, but will not remove tags received successfully by Device E.

VLAN Settings

To configure VLAN, click **VLAN** on the function menu, then select **IEEE 802.1Q**. Click **Global** tab.

GVRP (Generic VLAN Registration Protocol) is an IEEE 802.1Q standard protocol that helps specify how to define a method of tagging frames with VLAN configuration data. It essentially facilitates management of VLAN within a larger network data communication.

To edit the GVRP function, click the **GVRP** tab.

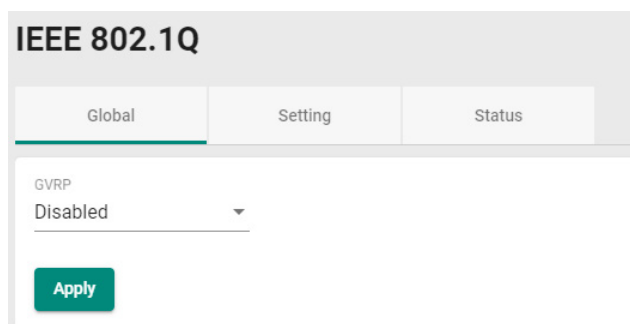

The screenshot shows the configuration page for IEEE 802.1Q. At the top, there are three tabs: 'Global', 'Setting', and 'Status'. The 'Global' tab is selected. Below the tabs, there is a dropdown menu for 'GVRP' which is currently set to 'Disabled'. Below the dropdown menu, there is a green 'Apply' button.

Configure the following setting.

GVRP

Setting	Description	Factory Default
Disabled	Disables GVRP.	Disabled
Enabled	Enables GVRP.	

Click **Apply** to finish.

VLAN Management Port Quick Setting

In the lower part of the configuration page, you can quickly configure VLAN setting.

Management VLAN
1

[Management Port Quick Setting](#)

Management Port i

Mode PVID GVRP Tagged VLAN Untagged VLAN

Apply

Configure the following settings.

Management VLAN

Setting	Description	Factory Default
Select the Management VLAN from the drop-down list	Show the list of selectable VLANs.	1

Management Port

Setting	Description	Factory Default
Select the port(s) as the VLAN port(s) from the drop-down list	To select the port(s) as the VLAN port(s).	None

When finished, click **Apply** to save your changes.

Detailed VLAN Settings

On the IEEE 802.1Q page, first click the **Setting** tab, and then click the edit icon.

IEEE 802.1Q

Global
Setting
Status

+
⌵
?

	VLAN	Name	Member Port
<input type="checkbox"/>	1		1/1, 1/3, 1/4, 2/1, 2/2, 2/3, 2/4, 3/1, 3/2, 3/3, 3/4, 4/1, 4/2, 4/3, 4/4, 5/1, 5/2, 5/3, 5/4, 6/1, 6/2, 6/3, 6/4, 7/1, 7/2, 7/3, 7/4, po1

Configure the following parameters.

Create VLAN

VID ^{*}

Max 10 VLANs

Name

0 / 32

Member Port ▼

Forbidden Port ▼

Cancel

Create

VID

Setting	Description	Factory Default
Input a VLAN ID, (10 VLANs max.)	Input a VLAN ID.	None

Name

Setting	Description	Factory Default
Input a name for the VLAN, (32 characters max.)	Specify a name for the VLAN.	None

Member Port

Setting	Description	Factory Default
Select the port from the drop-down list.	Specify the ports that are the member ports for the VLAN.	None

When finished, click **Create**.

Forbidden Port (in Advanced Mode only)

Setting	Description	Factory Default
Select the port from the drop-down list	Specify the ports that are forbidden for the VLAN.	None

Editing the Existing VLAN Settings

To edit the exiting VLAN settings, click the edit icon of the VLAN you want to edit.

<input type="checkbox"/>	VLAN	Name	Member Port
<input type="checkbox"/>	1		1/1, 1/3, 1/4, 2/1, 2/2, 2/3, 2/4, 3/1, 3/2, 3/3, 3/4, 4/1, 4/2, 4/3, 4/4, 5/1, 5/2, 5/3, 5/4, 6/1, 6/2, 6/3, 6/4, 7/1, 7/2, 7/3, 7/4, po1

Configure the following settings.

Edit VLAN 1 Setting

VID
1

Max 10 VLANs

Name
factory

Member Port
1/1, 1/3, 1/4, 2/1, 2/...

Forbidden Port

Cancel **Apply**

VID

Setting	Description	Factory Default
Show the VLAN ID	Display the VLAN ID.	None

Name

Setting	Description	Factory Default
Show the name of the VLAN	Display the VLAN name.	None

Member Port

Setting	Description	Factory Default
Select the port from the drop-down list	Specify the ports that are member ports for the VLAN.	None



When finished, click **Apply** to save your changes.

Forbidden Port (in Advanced Mode only)

Setting	Description	Factory Default
Select the port from the drop-down list	Specify the ports that are forbidden for the VLAN.	None

Editing the Port Settings

To edit the port settings, in the **VLAN** tab select the edit icon on the port you want to configure on the lower part of the page.

Port	Mode	PVID	GVRP	Untagged VLAN	Tagged VLAN
 1/1	Access	1	Disabled	1	
 1/3	Access	1	Disabled	1	
 1/4	Access	1	Disabled	1	

Configure the following settings.

Edit Port 1/1 Setting

Mode
 Access

PVID
 1

GVRP
 Disabled

Tagged VLAN

Untagged VLAN
 All Member VLANs

Copy Config to Ports 

Cancel

Apply

Mode

Setting	Description	Factory Default
Access	When this port is connected to a single device, without tags.	Access
Trunk	When this port is connected to another 802.1Q VLAN aware switch.	
Hybrid	When this port is connected to another Access 802.1Q VLAN aware switch or another LAN that combines tagged and/or untagged devices.	

PVID

Setting	Description	Factory Default
1 to 4094	Sets the default VLAN ID for untagged devices connected to the port.	None

GVRP

Setting	Description	Factory Default
Enabled	Enables GVRP.	Disabled
Disabled	Disables GVRP.	

Tagged VLAN

Setting	Description	Factory Default
1 to 4094	This field will be active only when selecting the Trunk or Hybrid port type. Set the other VLAN ID for tagged devices that connect to the port.	None

Untagged VLAN

Setting	Description	Factory Default
VID range from 1 to 4094	This field is only active when the Hybrid port type is selected. Set the other VLAN ID for tagged devices that connect to the port and tags that need to be removed in egress packets.	1

Copy Config to Ports

Setting	Description	Factory Default
Select the port(s) from the drop-down list	Copy the configuration to other port(s).	None



When finished, click **Apply** to save your changes.

GARP Overview

GARP stands for **Generic Attribute Registration Protocol**, which is a communication protocol defined by IEEE 802.1, offering a generic framework for bridges to register and de-register an attribute value. In a VLAN structure, two applications can be applied: **GARP VLAN Registration Protocol (GVRP)** is used to register VLAN trunking between multilayer switches, and **GARP Multicast Registration Protocol (GMRP)** for providing a constrained multicast flooding facility.

GARP Settings

Select **GARP** on the menu page, and then click the edit icon on the port you want to configure.

Port	Join Time	Leave Time	Leave All Time
 1/1	200	600	10000
 1/3	200	600	10000
 1/4	200	600	10000

Configure the following settings.

Edit Port 1/1 Setting

Join Time ^{*}

10 - 1073741820

Leave Time ^{*}

30 - 2147483630

Leave All Time ^{*}

40 - 2147483640

Copy Config to Ports i

Cancel

Apply

Join Time (sec.)

Setting	Description	Factory Default
10 to 499999980	Input the join time from 10 to 499999980 seconds.	200

Leave Time (sec.)

Setting	Description	Factory Default
30 to 499999980	Input the leave time from 30 to 499999980 seconds.	600

Leave All time (sec.)

Setting	Description	Factory Default
30 to 499999990	Input the leave all time.	10000

Copy Config to Ports

Setting	Description	Factory Default
Select the port(s) from the drop-down list	Copy the configurations to other port(s).	None

When finished, click **Apply** to save your changes.

MAC

This section explains Independent VLAN learning and describes how to configure **Static Unicast** and the **MAC Address Table**.

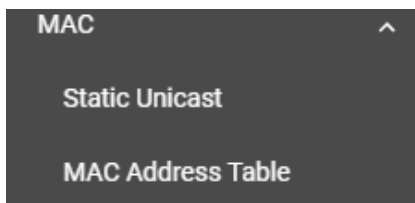

Independent VLAN Learning

Moxa’s switch uses the **Independent VLAN Learning (IVL)** mode.

In an **IVL Mode**, a MAC table will be created in each VLAN, which will constitute many MAC tables. However, the same VID record will be selected and put in a table. A MAC table will be stored in the format of MAC + VID, the same MAC will be stored in different tables with different VIDs.

Static Unicast

Click **Static Unicast** on the function menu page and click the **+** icon on the configuration page.



Configure the following settings.

Add Static Unicast Entry

VID

MAC Address *

Port *

Cancel

Create

VID

Setting	Description	Factory Default
Input a VLAN ID	Input a VLAN ID.	None

MAC Address

Setting	Description	Factory Default
MAC address of the port	Input the MAC address of the port.	None

Port

Setting	Description	Factory Default
Select the port from the drop-down list	Specify the port you want to create a VLAN for.	None

When finished, click **Create**.

MAC Address Table

Select **MAC Address Table**, and configure the following settings.

MAC Address Table

MAC Learning Mode
Independent VLAN learning

Aging Time
300

10 - 300 sec

Apply

MAC Learning Mode

Information	Description	Factory Default
Independent VLAN learning	Show the current MAC Learning Mode.	Independent VLAN learning

Aging Time

Setting	Description	Factory Default
10 to 300	Input a VLAN ID.	None

When finished, click **Apply** to save your changes.

You can view the current MAC Address Table on the bottom part of the configuration page.



Index	VLAN	MAC Address	Type	Port
1	1	c8:cb:b8:02:26:5f	Learnt Unicast	3/4

Item Name	Description
Index	The number of the MAC address.
VLAN	The VLAN number
MAC Address	The MAC address on this device.
Type	Learnt Unicast, Learnt Multicast, Static Unicast, Static: Multicast
Port	The forwarding port of this MAC address.

QoS

This section describes how QoS works and how to configure the settings.

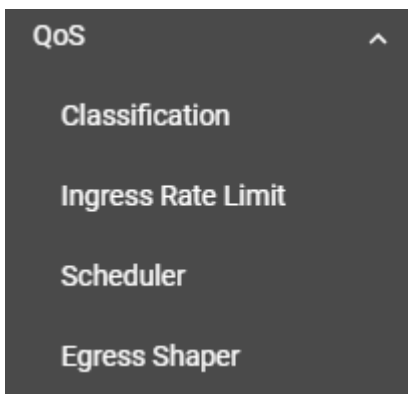

QoS Overview

The switch’s traffic prioritization capability provides Quality of Service (QoS) to your network by making data delivery more reliable. You can prioritize traffic on your network to ensure that high priority data is transmitted with minimum delay. Traffic can be controlled by a set of rules to obtain the required Quality of Service for your network. The rules define different types of traffic and specify how each type should be treated as it passes through the switch. The switch can inspect both IEEE 802.1p/1Q layer 2 CoS (Class of Service) tags, and even layer 3 DSCP (Differentiated Services Code Point) information to provide consistent classification of the entire network. The switch’s QoS capability improves the performance and determinism of industrial networks for mission-critical applications.

The Traffic Prioritization Concept

Traffic prioritization allows you to prioritize data so that time-sensitive and system-critical data can be transferred smoothly and with minimal delay over a network. The benefits of using traffic prioritization are:

- Improve network performance by controlling a wide variety of traffic and by managing congestion.
- Assign priorities to different categories of traffic. For example, set higher priorities for time-critical or mission-critical applications.
- Provide predictable throughput for multimedia applications, such as video conferencing or voice over IP, and minimize traffic delay and jitter.
- Optimize the network utilization depending on application usage and usage needs. Hence, asset owners do not always need to expand their backbone bandwidth as the amount of traffic increases.

Traffic prioritization uses eight traffic queues to ensure that higher priority traffic can be forwarded separately from lower priority traffic, which guarantees Quality of Service (QoS) to your network.

Moxa switch traffic prioritization is based on two standards:

- **IEEE 802.1p** - a layer 2 QoS marking scheme
- **Differentiated Services (DiffServ)**—a layer 3 QoS marking scheme.

IEEE 802.1p Class of Service

The IEEE Std 802.1D 2005 Edition marking scheme, which is an enhancement to IEEE Std 802.1D, enables Quality of Service on the LAN. Traffic service levels are defined in the IEEE 802.1Q 4-byte tag, which is used to carry VLAN identification as well as IEEE 802.1p priority information. The IEEE 802.1p occupying 3 bits of the tag follows the destination MAC address and Source MAC address.

The IEEE Std 802.1D 2005 Edition priority marking scheme assigns an IEEE 802.1p priority level between 0 and 7 to each frame, which specifies the level of service that the associated packets shall be handled. The table below shows an example of how different traffic types can be mapped to the eight IEEE 802.1p priority levels.

IEEE 802.1p Priority Level	IEEE 802.1D Traffic Type
0	Best Effort
1	Background (lowest priority)
2	Reserved
3	Excellent Effort (business critical)
4	Controlled Load (streaming multimedia)
5	Video (interactive media)
6	Voice (interactive voice)
7	Network Control Reserved traffic

Even though the IEEE 802.1p standard is the most widely used prioritization scheme for LAN environments, it still has some restrictions:

- It requires an additional 4-byte tag in the frame, which is normally optional for Ethernet networks. Without this tag, the scheme cannot work.
- The tag is part of the IEEE 802.1Q header, so to implement QoS at layer 2, the entire network must implement IEEE 802.1Q VLAN tagging.
- It is only supported within a LAN and does not cross the WAN boundaries, since the IEEE 802.1Q tags will be removed when the packets pass through a router.

Differentiated Services (DiffServ) Traffic Marking

DiffServ is a Layer 3 marking scheme that uses the DiffServ Code Point (DSCP) field in the IP header to specify the packet priority. DSCP is an advanced intelligent method of traffic marking that allows you to choose how your network prioritizes different types of traffic. The DSCP field can be set from 0 to 63 to map to user-defined service levels, enabling users to regulate and categorize traffic by applications with different service levels.

The advantages of DiffServ over IEEE 802.1Q are as follows:

- You can prioritize and assign different traffic with appropriate latency, throughput, or reliability by each port.
- No extra tags are required.
- The DSCP priority tags are carried in the IP header, which can pass the WAN boundaries and through the Internet.
- DSCP is backwards compatible with IPv4 ToS (Type of Service), which allows operation with legacy devices that use IPv4 layer 3.

Traffic Prioritization

Moxa switches classify traffic based on layer 2 of the OSI 7 layer model, and the switch prioritizes outbound traffic according to the priority information defined in the received packet. Incoming traffic is classified based upon the IEEE 802.1p service level field and is assigned to the appropriate egress priority queue. The traffic flow through the switch is as follows:

- A packet received by the Moxa switch may or may not have an 802.1p tag associated with it. If it does not, then it is given a default CoS value (according to the port settings in the classification section). Alternatively, the packet might be marked with a new 802.1p value, which will result in all knowledge of the previous 802.1p tag being lost.
- Each egress queue has associated 802.1p priority levels, and can be defined by users, the packet will be placed in the appropriate priority queue. When the packet reaches the head of its queue and is about to be transmitted, the device determines whether or not the egress port belongs to the VLAN group. If it is, then the new 802.1p tag is used in the extended 802.1D header.

Traffic Queues

The hardware of Moxa switches has multiple traffic queues that allow packet prioritization to occur. Higher priority traffic can pass through the Moxa switch without being delayed by lower priority traffic. As each packet arrives in the Moxa switch, it undergoes ingress processing (which includes classification, marking/re-marking), and is then sorted into the appropriate queue. The switch then forwards packets from each queue.

Moxa switches support two different queuing mechanisms:

- **Weight Fair:** This method services all the traffic queues, giving priority to the higher priority queues. Under most circumstances, the Weight Fair method gives high priority precedence over low priority, but in the event that high priority traffic does not reach the link capacity, lower priority traffic is not blocked.
- **Strict:** This method services high traffic queues first; low priority queues are delayed until no more high priority data needs to be sent. The Strict method always gives precedence to high priority over low priority.

Classification

There are three parameters in this section: **DSCP Mapping**, **CoS Mapping**, and **Port Setting**. The three parameters are described below in detail.

DSCP to CoS Mapping

In the **Classification** menu, click the **DSCP Mapping** tab, and then click the edit icon.

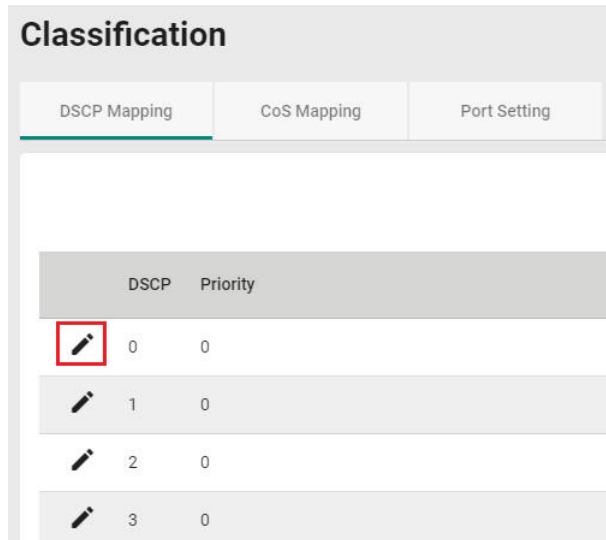

Configure the priority setting from the drop-down list for this port.

Edit DSCP 0 Setting

Priority
0

Cancel

Apply

DSCP Value and Priority

Setting	Description	Factory Default
0 to 7	Different DSCP values map to one of eight different priorities from 0 to 7.	0
8 to 15		1
16 to 23		2
24 to 31		3
32 to 39		4
40 to 47		5
48 to 55		6
56 to 63		7

When finished, click **Apply** to save your changes.

CoS to Queue Mapping

In the **Classification** menu, click the **CoS Mapping** tab, and then click the edit icon.

Classification

DSCP Mapping
CoS Mapping
Port Setting

	CoS	Queue
	0	1
	1	2
	2	3
	3	4

Configure the Queue priority setting for the port.

Edit CoS 0 Setting

Queue
1 ▼

Cancel

Apply

Queue Priority

Setting	Description	Factory Default
0	Different 802.1p values map to one of the eight different queues from 1 (lowest priority) to 8 (highest).	1
1		2
2		3
3		4
4		5
5		6
6		7
7		8

Port Settings

In the **Classification** menu, click the **Port Setting** tab, and then click the edit icon.

Classification

DSCP Mapping
CoS Mapping
Port Setting

	Port	Trust Type	Priority
	1/1	CoS	3
	1/2	CoS	3
	1/3	CoS	3
	1/4	CoS	3

Configure the following settings.

Edit Port 1/1 Setting

Trust Type
CoS ▼

Untag Default Priority
3 ▼

Copy Config to Ports ▼ i

Cancel

Apply

Trust Type

Setting	Description	Factory Default
CoS	Enables the port with CoS-based traffic classification.	CoS
DSCP	Enables the port with DSCP-based traffic classification.	

Untag Default Priority

Setting	Description	Factory Default
0 to 7	802.1p tag (CoS) can be range from 0 (lowest) to 7 (highest).	3

Copy Config to Ports

Setting	Description	Factory Default
Select from the drop-down list	Copy the settings to other ports you select.	None

When finished, click **Apply** to save your changes.

Ingress Rate Limit

Ingress Rate Limit Overview

The rate limit is composed of the meter and the marker. The meter is the monitoring of the data rates for a particular class of traffic. When the data rate exceeds user-configured values, marking or dropping of packets occurs immediately. The meter does not buffer the traffic; therefore, the transmission delay is not affected. When traffic exceeds the user’s specified value, you can instruct the system to either drop the packets or mark QoS fields in them. The meter algorithms include simple token bucket and SrTCM (Single Rate Three Color Marker) (RFC2697). The marker of the rate limit is included and remarked in the 802.1p or the DSCP field of the packet.

Simple Token Bucket

The Token Bucket Concept

Token Bucket is an algorithm used to achieve an efficient network flow control and manage bandwidth. This algorithm is based on a token bucket that allows for a traffic surge for short periods. When a token is unavailable, no burst of packets can be sent. Under this concept, the number of tokens will be refilled in the bucket at specific intervals. Users need to configure these settings so that the tokens in the bucket are always available to ensure packets can be sent when necessary.

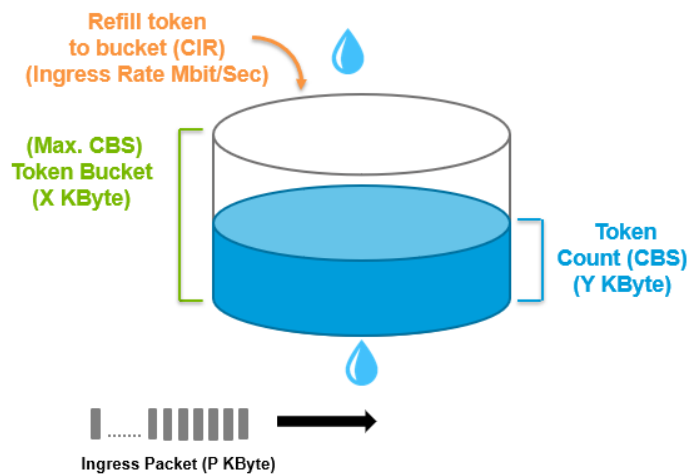

CAR (Committed Access Rate) is a traffic control mechanism used to ensure that packets meet the network rules before they enter the network. CAR can guarantee the traffic flow is under user-defined control; the packets exceeding the rule will be either dropped or remarked and transmitted again. When network traffic is jammed, these packets will be dropped first.

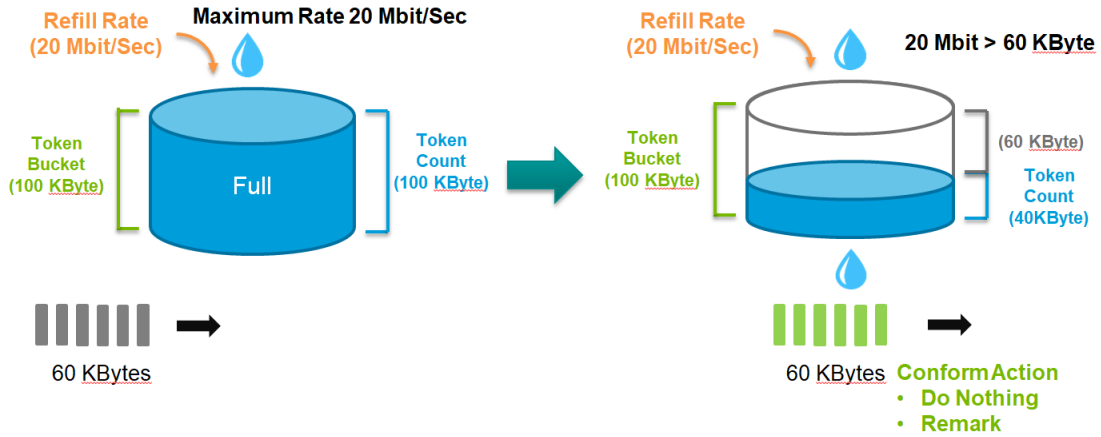

Token Bucket is an algorithm that is demonstrated as a container in the image below. The token can be seen as a marker to mark a packet that is allowed to be transmitted through this switch. When the token is flowing into the bucket, the length of the bucket will be consumed as the volume of the bucket is limited. When the volume of the bucket is insufficient, some packets will be dropped or remarked and transmitted again. This algorithm can control the speed of the traffic flow by consuming the speed of the token in the bucket.

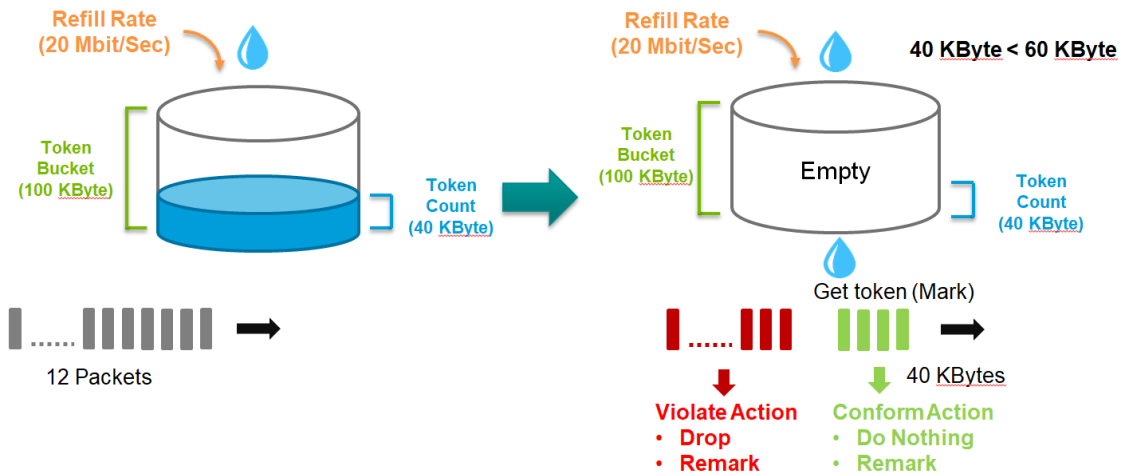

Simple Token Bucket Concept

In the Simple Token Bucket algorithm, two methods will be used:

CIR: Committed Information Rate: Users can pre-configure the CIR. To determine the size of the bucket, they will be sent along with the available tokens. When tokens are unavailable, the packets will not be sent until the tokens are added into the bucket. This guarantees sufficient network bandwidth and efficient flow control.

CBS: Committed Burst Rate: The tokens will be saved in both the CBS bucket and EBS bucket. When both buckets are full of tokens, the exceeding tokens will be dropped. This ensures that the specific amount of tokens are available so that the packet transmission can be stable.

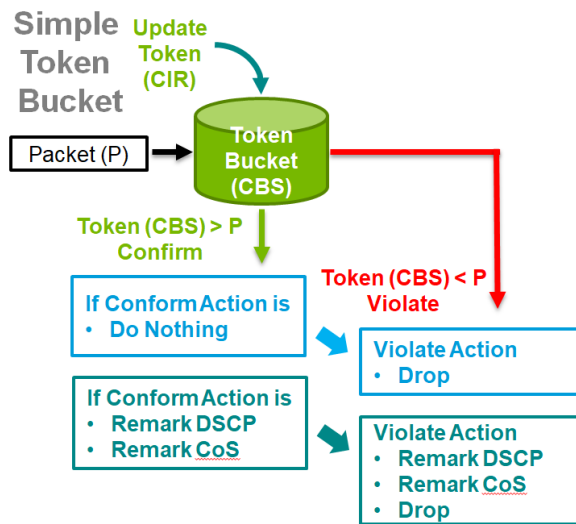

SrTCM (Single Rate Three Color Marker)

SrTCM Overview

SrTCM stands for A **Single Rate Three Color Marker**, which is another policing scheme for ingress rate limit. Traffic marking is based on a Committed Information Rate (CIR) and two associated burst sizes, a Committed Burst Size (CBS) and an Excess Burst Size (EBS). A packet is marked green if it does not exceed the CBS, yellow if it does exceed the CBS, but not the EBS, and red otherwise.

How SrTCM Works

SrTCM will categorize the ingress packet by its length, and mark it as one of three colors:

Red: performs the "violate" action.

Yellow: performs the "exceed" action. The Token Bucket (EBS) will deduct corresponding tokens.

Green: performs the "conform" action. The Token Bucket (CBS) will deduct corresponding tokens.

The SrTCM is useful for ingress policing of a service, where only the length, not the peak rate, of the burst determines service eligibility.

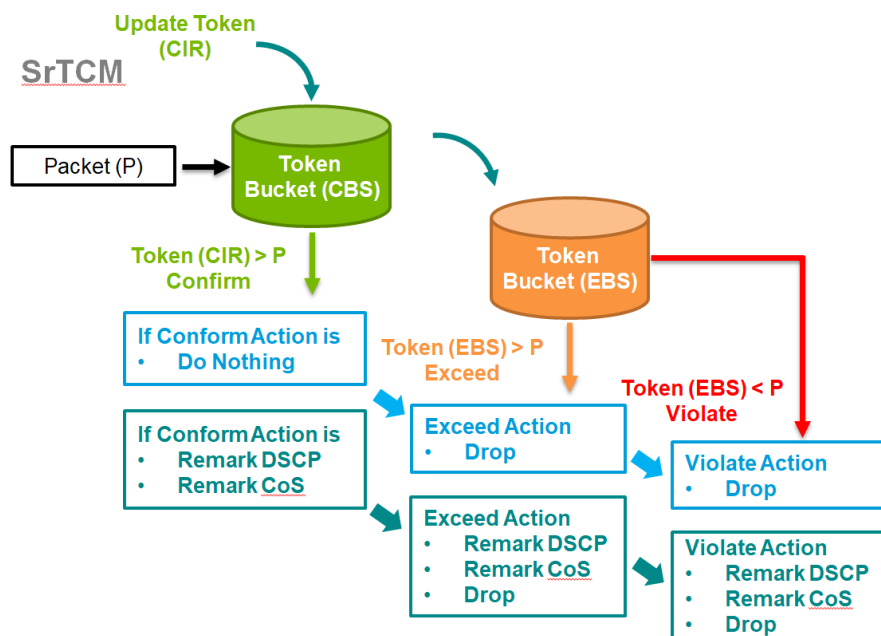

Exceed Rate Limit Threshold Port Shutdown

In general, any user shall not consume unlimited bandwidth and influence others' access. One particular scenario is that a malfunctioning switch or mis-configured network might cause "broadcast storms". Moxa industrial Ethernet switches not only prevent broadcast storms, but can also regulate ingress packet rates, giving administrators full control of their limited bandwidth to prevent undesirable effects caused by unpredictable faults.

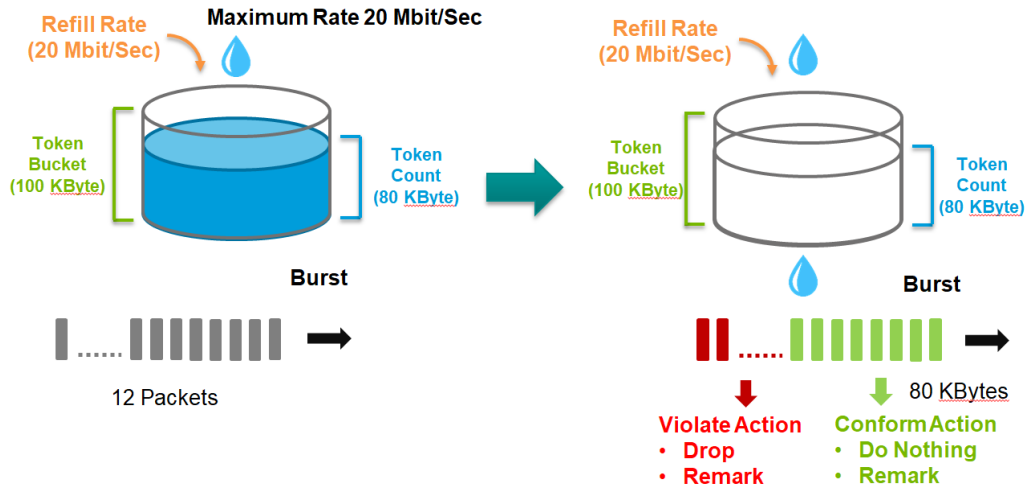

Editing Ingress Rate Limit

Switch to **Advanced Mode** before configuring the settings in this section.

On the **Ingress Rate Limit** menu, click the **General** tab, and then click the edit icon.

Ingress Rate Limit

General

Port Shutdown

Port	Type	Ingress Rate (CIR)	CBS	EBS	Mode	Confirm Action	Exceed Action	Violate Action
1/1	Simple Token Bucket	1000	1024	1024	Color-Blind	Do Nothing	Drop	Drop
1/2	Simple Token Bucket	1000	1024	1024	Color-Blind	Do Nothing	Drop	Drop
1/3	Simple Token Bucket	1000	1024	1024	Color-Blind	Do Nothing	Drop	Drop
1/4	Simple Token Bucket	1000	1024	1024	Color-Blind	Do Nothing	Drop	Drop

Configure the following settings.

Edit Port 1/1 Setting

Type
Simple Token Bucket

Ingress Rate (CIR)
1000
1 - 1000 Mbps

CBS
1024
10 - 10240 KByte

Confirm Action
Do Nothing

Violate Action
Drop

Copy Config to Ports 

Cancel

Apply

Type

Setting	Description	Factory Default
Simple Token Bucket	Specify Simple Token Bucket as Ingress Limit type.	Simple Token Bucket
SrTCM	Specify SrTCM as Ingress Limit type.	

Ingress Rate (CIR) (Mbps)

Setting	Description	Factory Default
1 to 1000	Define the specific incoming data communication speed given to this port.	1000

CBS (Committed Burst Size) (Kbyte)

Setting	Description	Factory Default
0 to 10240	Input the specific data communication speed given to this port when the data rate exceeds the CIR rate. The data that exceeded the CIR rate will be saved in temporary storage, and will be sent when bandwidth is available.	1024

EBS (Excess Burst Size) (Kbyte)

Setting	Description	Factory Default
0 to 10240	Input the specific data communication speed given to this port when the data rate exceeds the CIR rate. The data that exceeded the CIR rate will be saved in temporary storage, and will be sent when bandwidth is available.	1024

Confirm Action

Setting	Description	Factory Default
Do Nothing	Do nothing.	Do Nothing
Remark CoS	Remark the CoS value.	
Remark DSCP	Remark the DSCP value.	

Violate Action

Setting	Description	Factory Default
Drop	Drop the packet if the packet violates CIR and CBS.	Drop
Remark CoS	Remark the CoS value if the packet is marked as violated.	
Remark DSCP	Remark the DSCP value if the packet is marked as violated.	

Copy Config to Ports

Setting	Description	Factory Default
Select the port(s) from the drop-down list	Copy the configurations to other port(s).	None

When finished, click **Apply** to save your changes.

Editing Port Shutdown

To edit the port shutdown configurations, click the **Port Shutdown** tab.

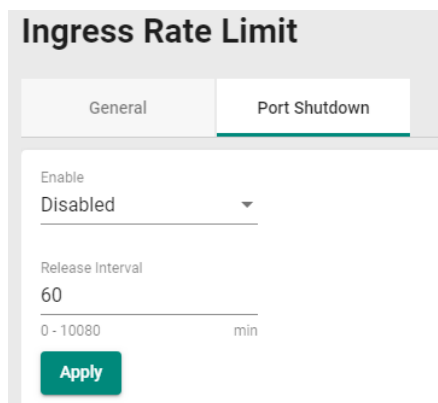

Configure the following settings.

Enable

Setting	Description	Factory Default
Enable	Enable the port to be shut down.	Disabled
Disable	Disable the ability for the port to be shut down.	





Release Interval (min.)

Setting	Description	Factory Default
0 to 10080	Specify the release interval for the port to shut down. 0 means this port will be shut down until manually enabled.	60

When finished, click **Apply** to save your changes.

Editing the Port for Port Shutdown

Edit the specific port that you want to edit the port shutdown configurations for.

	Port	Enable	Threshold (Mbps)
	1/1	Disabled	1000
	1/2	Disabled	1000
	1/3	Disabled	1000
	1/4	Disabled	1000

Configure the following settings.

Edit Port 1/1 Setting

Enable
 Disabled ▼

Threshold *
 1000

1 - 1000 Mbps

Copy Config to Ports ▼ 

Cancel

Apply

Enable

Setting	Description	Factory Default
Enable	Enable port shutdown for this port.	Disable
Disable	Disable port shutdown for this port.	

Threshold (Mbps)

Setting	Description	Factory Default
1 to 1000	Specify the threshold for port shutdown	1000

Copy Config to Ports

Setting	Description	Factory Default
Select the port(s) from the drop-down list	Copy the configurations to other port(s).	None

When finished, click **Apply** to save your changes.

Scheduler

Scheduler Overview

Scheduler is an arbiter in switch forwarding path to prioritize traffic flows by users' defined criteria. This essentially enhances data transmission efficiency and guarantees that critical packets can be transmitted earlier. Moxa's switches support two scheduling algorithms: Strict Priority and Weighted Round Robin.

Strict Priority





The **Strict Priority** type allows users to determine to transmit packets in the highest priority queue first, while packets with lower priority will be transmitted later. This guarantees that traffic with the highest level of priority for data transmission will go first.

Weighted Round Robin

The **Weighted Round Robin** type allows users to give priority to specific packets in the higher weighted queue to ensure those packets will be sent first. Moxa switches now have 8 queues, and the weights from highest to lowest are 8:8:4:4:2:2:1:1.

Scheduler Settings

Select **Scheduler** in the menu and then click the edit icon on the port you want to configure.

Scheduler		
Port	Type	
 1/1	SP	
 1/2	SP	
 1/3	SP	
 1/4	SP	

Configure the following settings.

Edit Port 1/1 Setting

Type
Strict Priority ▼

Copy Config to Ports ▼ 

Cancel

Apply

Type

Setting	Description	Factory Default
Strict Priority	Set scheduler algorithm as Strict Priority.	Strict Priority
Weighted Round Robin	Set the scheduler algorithm as Weighted Round Robin: The queued packet will be forwarded by its associated weight.	

Copy Config to Ports

Setting	Description	Factory Default
Select the port from the drop-down list	Copy the same settings to other ports.	None

When finished, click **Apply** to save your changes.

Egress Shaper Overview

A shaper typically delays excess traffic using a buffer or queueing mechanism to hold packets and shape the flow when the data rate of the source is higher than expected. There are two possible metering algorithms: token bucket, or leaky bucket. The leaky bucket algorithm works similarly to the way an actual leaky bucket holds water: The leaky bucket takes data and collects it up to a maximum capacity. Credit in the bucket is only released from the bucket at a set rate. When the bucket consumes all data, the leaking will stop. If incoming data would overflow the bucket, then the packet is considered to be non-conformant and is not added to the bucket. Data will be added back to the bucket as space becomes available for conforming packets.

Egress Shaper Settings and Status

This section describes how to configure Egress Shaper. Switch to **Advanced Mode** first, and select **Egress Shaper** in the menu and then click the edit icon on the port you want to configure.

Egress Shaper

	Port	Egress Rate (CIR)	CBS
	1/1	1000	1024
	1/2	1000	1024
	1/3	1000	1024
	1/4	1000	1024

Configure the following settings.

Edit Port 1/1 Setting

CIR 1 - 1000 Mbps

CBS* 10 - 10240 KByte

Copy Config to Ports i

Cancel

Apply

CIR (Committed Information Rate) (Mbps)

Setting	Description	Factory Default
1 to 1000	The average committed data transmission rate.	1000

CBS (Committed Burst size) (Kbyte)

Setting	Description	Factory Default
10 to 10240	The maximum traffic amount (in Kbyte) that can be transmitted within a very short interval of time or burst.	1024





Copy Config to Ports

Setting	Description	Factory Default
Select the port from the drop-down list	Copy the same settings to the other ports.	None

When finished, click **Apply** to save your changes.

You can view the Egress Shaper status.

Egress Shaper

Port	Egress Rate (CIR)	CBS
 1/1	1000	1024
 1/2	1000	1024
 1/3	1000	1024
 1/4	1000	1024

Multicast

Multicast filtering improves the performance of networks that carry multicast traffic. This section will explain the Layer 2 multicast settings, such as **IGMP Snooping**, **GMRP**, and **Static Multicast**.

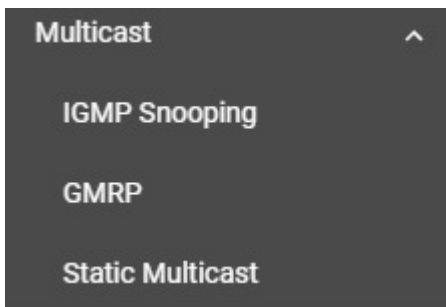

IGMP Snooping

IGMP Snooping Overview

IGMP stands for **Internet Group Management Protocol**, which is a network communication protocol that hosts nearby routers on networks to construct multicast group memberships.

IGMP snooping allows a network switch to listen in on the IGMP conversation between hosts and routers. By listening to these conversations, the switch maintains an association mapping table between port(s) and multicast group.

How IGMP Snooping Works

A switch will, by default, flood multicast traffic to all the other ports, aside ingress, in a broadcast domain (or the VLAN equivalent). Multicast can cause unnecessary loading for host devices by requiring them to process packets they have not solicited. IGMP snooping is designed to prevent hosts on a local network from receiving traffic for a multicast group they have not explicitly joined. It provides switches with a mechanism to forward multicast traffic to specific ports that receive IGMP hosts. Hence, IGMP snooping can utilize the network bandwidth more efficiently.

Without IGMP Snooping

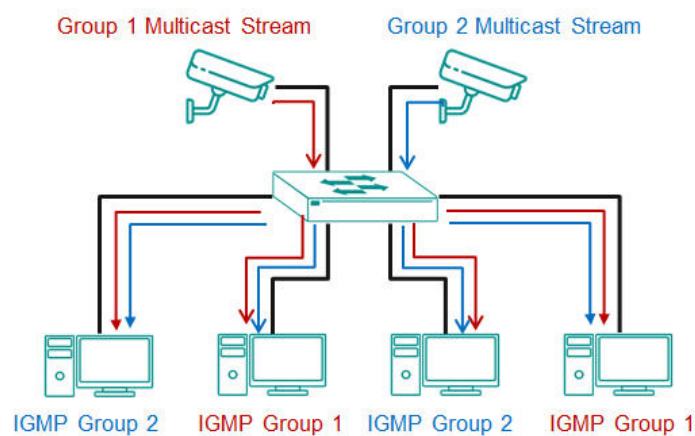

With IGMP Snooping

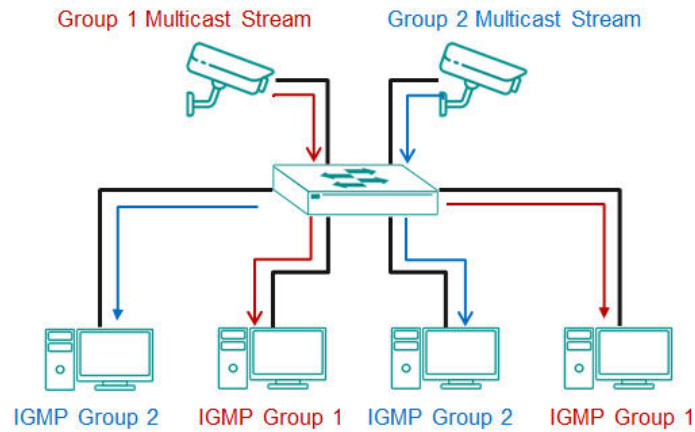

Differences Between IGMP Snooping V1, V2, and V3

IGMP protocols regulate the communication mechanism between querier and listener. IGMP Snooping has three different versions. Refer to the following table for the detailed differences.

IGMP Version	Main Features	Reference
V1	The IGMPv1 querier will periodically send out a "query". Listeners can solicit a "report" of their interested group. However, IGMPv1 does not have a "leave group" message, and the querier might need to implement a timeout mechanism for each registered group.	RFC-1112
V2	Compatible with V1 and the following functions: a. Group-specific query b. Leave group messages c. Resends specific queries to verify leave message was the last one in the group d. Querier election if multiple capable queries are present.	RFC-2236
V3	Compatible with V1, V2, and the following functions: Source filtering enables hosts to specify: - the multicast traffic from a specified source - the multicast traffic from any source except a specified source	RFC-3376

IGMP Snooping Settings

First, select **IGMP Snooping** on the menu and then click the **General** tab on the configuration page.

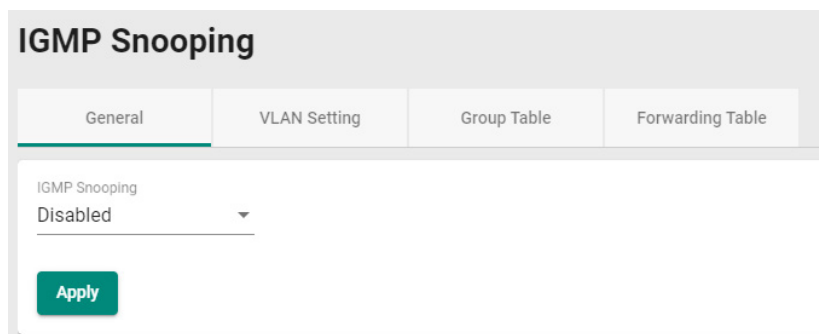

Enable

Setting	Description	Factory Default
Enabled	Enable IGMP Snooping on a specific VLAN.	Disabled
Disabled	Disable IGMP Snooping on a specific VLAN.	

Configuring VLAN Setting

Click the **VLAN Setting** tab, and then click the edit icon to configure the VLAN settings.

IGMP Snooping

General | **VLAN Setting** | Group Table | Forwarding Table

VLAN	Enable	Version	Query Interval	Config Role	Active Role	Static Router Port
1	Disabled	2	125	Querier	Non-Querier	
2	Disabled	2	125	Querier	Non-Querier	

Edit VLAN 1 Setting

Enabled
 Disabled ▼

Version *
 2 ▼

Query Interval *
 125
 20 - 600 sec

Static Router Port ▼

Config Role *
 Querier ▼

Cancel

Apply

Enable

Setting	Description	Factory Default
Enabled	Enable IGMP Snooping on a switch.	Disabled
Disabled	Disable IGMP Snooping on a switch.	

Version

Setting	Description	Factory Default
1, 2, 3	Specify the IGMP version of the packets that the switch listens to and send queries for.	2

Query Interval (sec)

Setting	Description	Factory Default
20 to 600	Specify the query interval for the Querier function globally (Querier has to be enabled.)	125

Static Router Port

Setting	Description	Factory Default
Check the port from the drop-down list	The router port is the port that connects to the upper level router (or IGMP querier), or to the upper level router of downstream multicast streams. All of the received IGMP signaling packets or multicast streams will be forwarded to those static router ports.	None

Config Role

Setting	Description	Factory Default
Querier	The switch will act as the Querier role.	Querier
Non-Querier	The switch will not act as the Querier role.	

When finished, click **Apply** to save your changes.

Viewing the Group Table

Click the **Group Table** tab, which allows you to view the current Group Table status.

Refer to the following table for the detailed description for each item.

Item	Description
VLAN	The VLAN ID.
Group Address	The registered multicast group.
Filter Mode	Only applicable for IGMPv3. (v1 and v2 will display "N/A") Include: source-specific multicast address group Exclude: source-specific exclusive multicast address group
Port	The forwarded port.
Source Address	Only applicable for IGMPv3. (v1 and v2 will display N/A)

Viewing the Forwarding Table

Click the **Forwarding Table** tab to view the current forwarding table.

Refer to the following table for a description of each item.

Item	Description
VLAN	The VLAN ID.
Group Address	The associated multicast group address of the streaming data.
Source Address	The source address of the streaming data.
Port	The forwarded port.

GMRP

GMRP stands for GARP Multicast Registration Protocol, which is a Generic Attribute Registration Protocol (GARP) application that can be used to prevent multicast from data flooding. Both GMRP and GARP are defined by the IEEE 802.1P, and widely used as a standard protocol in various industrial-related applications. GMRP allows bridges and the devices at the edge of the network to perform a dynamic group membership information registration with the MAC bridges connected to the same LAN section. The information can be transmitted among all bridges in the Bridge LAN that is implemented with extended filtering features. To operate GMRP, the GARP service must be established first.

Configuring GMRP Setting

To configure the GMRP settings, click **GMRP** on the menu.

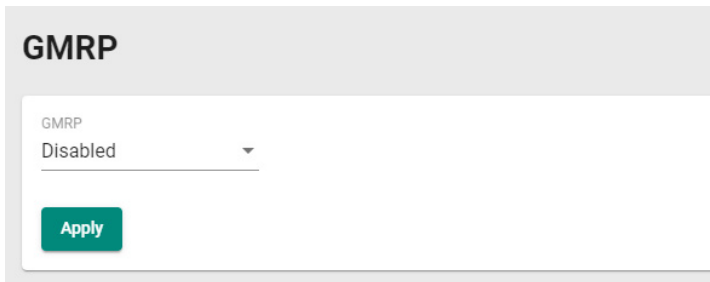

Configure the following settings.



Enable

Setting	Description	Factory Default
Enabled	Enable GMRP.	Disabled
Disabled	Disable GMRP.	

When finished, click **Apply** to save your changes.

Configuring GMRP Settings for Each Port

Next, click the edit icon on the port you want to configure.

Port	Enable	Group Restrict
 1/3	Disabled	Disabled
 1/4	Disabled	Disabled

Configure the following settings.

Edit Port 1/3 Setting

Enable
 Disabled ▼

Group Restrict
 Disabled ▼

Copy Config to Ports ▼ i

Cancel

Apply

Enable

Setting	Description	Factory Default
Enabled	Enable GMRP for this port.	Disabled
Disabled	Disable GMRP for this port.	

Group Restrict

Setting	Description	Factory Default
Enabled	Enable Group Restrict on the port. This specific port will not process any GMRP control packets.	Disabled
Disabled	Disable Group Restrict on the port. The specific port will receive and process incoming GMRP control packets.	

Copy Config to Ports

Setting	Description	Factory Default
Select the port(s) from the drop-down list	Allows you to copy the configurations to other port(s).	None

When finished, click **Apply** to save your changes.

Static Multicast

Click **Static Multicast** on the menu to view the current multicast table.

Adding Static Multicast Entry

To add more tables, click the + icon.

Static Multicast Table

+
+

<input type="checkbox"/>	VLAN	MAC Address	Egress Port	Forbidden Port
Max 256				

Configure the following settings.

Add Static Multicast Entry

VID *

MAC Address *

Egress Port * ▼

Forbidden Port ▼

Cancel

Create

VID (VLAN ID)

Setting	Description	Factory Default
Input the VID	Specify the multicast group's associated VLAN ID.	None

MAC Address

Setting	Description	Factory Default
Input the MAC address	Specify the multicast MAC address.	None

Egress Port

Setting	Description	Factory Default
Input the port from the drop-down list	Set the port(s) as an egress port(s) so that multicast streams can be forwarded to this port.	None

Forbidden Port

Setting	Description	Factory Default
Input the port from the drop-down list	Set the port as forbidden so that packets cannot be forwarded to this port.	None

When finished, click **Create**.

Network Redundancy

Setting up the Redundancy Protocol on your network helps protect critical links against failure, protects against network loops, and keeps network downtime to a minimum.

The Redundancy Protocol allows you to set up redundant paths on the network to provide a backup data transmission route in the event that a cable or one of the switches is inadvertently disconnected or damaged. This is a particularly important feature for industrial applications, since it can take several minutes to address the link down port or failed switch. For example, if a Moxa switch is used as a key communications device for a production line, several minutes of downtime can cause a big loss in production and revenue. Moxa switches support the following Redundancy Protocol functions:

- **Spanning Tree**
- **Turbo Ring V2**
- **Turbo Chain**
- **Dual Homing**

Layer 2 Redundancy

First select **Network Redundancy** on the menu and then click **Layer 2 Redundancy**.

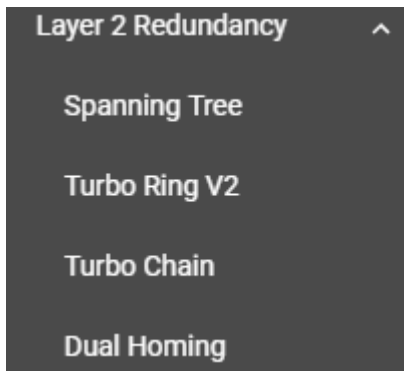

Spanning Tree

Spanning Tree Overview

Spanning Tree Protocol (STP) was designed to help construct a loop-free logical topology on an Ethernet network, and provide an automatic means of avoiding any network loops. This is particularly important for networks that have a complicated architecture, since unintended loops in the network can cause broadcast storms. Moxa switches' STP feature is disabled by default. To be completely effective, you must enable STP/RSTP on every Moxa switch connected to your network.

STP (802.1D) is a bridge-based system that is used to implement parallel paths for network traffic. STP uses a loop-detection process to:

- Locate and then disable less efficient paths (e.g., paths that have lower bandwidth).
- Enable one of the less efficient paths if a more efficient path fails.

How STP Works

The figure below shows a network made up of three LANs separated by three bridges. Each segment uses at most two paths to communicate with the other segments. Since this configuration can give rise to loops, the network will overload if STP is not enabled.

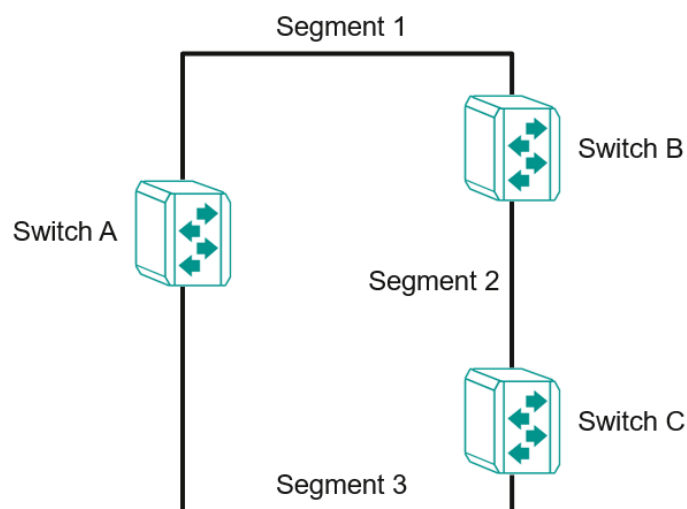

If STP is enabled, it will detect duplicate paths or block one of the paths from forwarding traffic. In the following example, STP determined that traffic from segment 2 to segment 1 flows through switches C and A since this path is in a forwarding state and is processing BPDUs. However, switch B on segment 1 is in a blocking state.

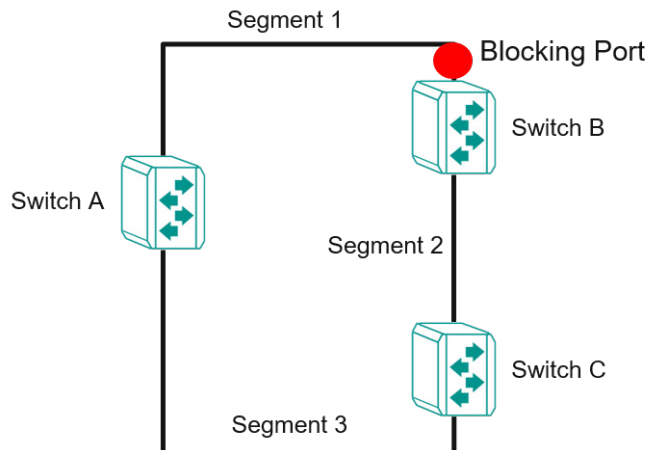

What happens if a link failure is detected? As shown in the figure below, the STP will change the blocking state to a forwarding state so that traffic from segment 2 flows through switch B to segment 1 through a redundant path.

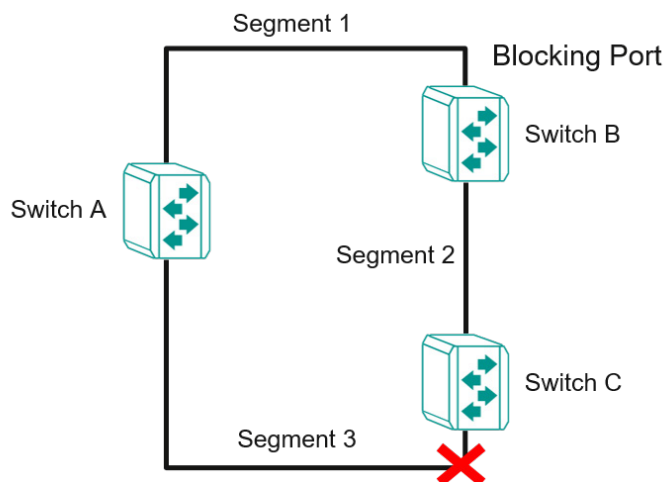

STP will determine which path between each segment is most efficient, and then assign a specific reference point on the network. When the most efficient path has been identified, the other paths are blocked. In the previous three figures, STP first determined that the path through switch C was the most efficient, and as a result, blocked the path through switch B. After the failure of switch C, STP re-evaluated the situation and opened the path through switch B.

Difference Between STP and RSTP

RSTP is similar to STP but includes additional information in the BPDUs that allow each bridge to confirm that it has taken action to prevent loops from forming when it decides to enable a link to a neighboring bridge. Adjacent bridges connected via point-to-point links will be able to enable a link without waiting to ensure that all other bridges in the network have had time to react to the change. The main benefit of RSTP is that the configuration decision is made locally rather than network-wide, allowing RSTP to carry out automatic configuration and restore a link faster than STP.

STP and RSTP spanning tree protocols operate without regard to a network’s VLAN configuration and maintain one common spanning tree throughout a bridged network. Thus, these protocols map one loop-free, logical topology on a given physical topology.

STP/RSTP Settings and Status

This section describes how to configure Spanning Tree settings.

General

Click **Spanning Tree** on the menu and then select the **General** tab.

Configure the following settings.

Enable

Setting	Description	Factory Default
Enabled	Enable Spanning Tree.	Disabled
Disabled	Disable Spanning Tree.	

STP Mode

Setting	Description	Factory Default
STP/RSTP	Use the STP/RSTP mode as the Spanning Tree protocol.	STP/RSTP

Compatibility

Setting	Description	Factory Default
STP	To be compatible with STP mode only	RSTP
RSTP	To be compatible with RSTP and STP modes	

Bridge Priority

Setting	Description	Factory Default
0 to 61440	Increase this device’s bridge priority by selecting a lower number. A device with a higher bridge priority has a greater chance of being established as the root of the Spanning Tree topology.	32768

Forwarding Delay Time (sec.)

Setting	Description	Factory Default
4 to 30	The amount of time the device waits before checking to see if it should change to a different state.	15

Hello Time (sec.)

Setting	Description	Factory Default
1 or 2	The root of the Spanning Tree topology periodically sends out a	2

	"hello" message to other devices on the network to check if the topology is healthy. The "hello time" is the amount of time the root waits between sending hello messages.	
--	----------------------------------------------------------------------------------------------------------------------------------------------------------------------------	--

Max Age (sec.)

Setting	Description	Factory Default
6 to 40	If this device is not the root, and it has not received a hello message from the root in the amount of time equal to "Max. Age," then this device will reconfigure itself as a root. Once two or more devices on the network are recognized as a root, the devices will renegotiate a new Spanning Tree topology.	20

Error Recovery Time (sec.)

Setting	Description	Factory Default
30 to 65535	If the BPDU guard is triggered on a port, it will automatically recover to the normal state after the Error Recovery Time.	300

When finished, click **Apply** to save your changes.

Editing Spanning Tree for a Port

To edit the spanning tree settings for a specific port, click the edit icon on the port you want to configure.

	Port	Enable	Edge	Priority	Path Cost	Link Type
	1/3	Disabled	Auto	128	0	Auto
	1/4	Disabled	Auto	128	0	Auto

Configure the following settings.

Edit Port 1/3 Setting

Enable
 Disabled ▼

Edge
 Auto ▼

Priority *
 128
0 - 255, multiples of 16

Path Cost * i
 0
0 - 200000000

Link Type
 Auto ▼

Copy Config to Ports ▼ i

Cancel

Apply

Enable

Setting	Description	Factory Default
---------	-------------	-----------------

Enabled	Enable Spanning Tree.	Disabled
Disabled	Disable Spanning Tree.	

Edge

Setting	Description	Factory Default
Auto	Automatically detect to be the edge port.	Auto
Yes	Set as an edge port.	
No	Do not set as an edge port.	

Priority

Setting	Description	Factory Default
0 to 255 (multiples of 16)	Increase the priority of a port by selecting a lower number. A port with a higher priority has a greater chance of being a root port.	128

Path Cost

Setting	Description	Factory Default
0 to 20000000	The path cost value will be automatically assigned according to the different port speed if the value is set to zero.	0

Link Type

Setting	Description	Factory Default
Force True	Set to Force True when port operating in full-duplex mode, such as a switch.	Auto
Force False	Set to Force False when port operating in half-duplex mode, such as a hub.	
Auto	Automatically select Force True or Force False mode.	

Copy Config to Ports

Setting	Description	Factory Default
Select the port(s) from the drop-down list	Copy the configurations to other port(s).	None

Click **Apply** to finish.

BPDU Overview

BPDUs (Bridge Protocol Data Units) are the network communication frames used in the STP (Spanning Tree Protocol). When two switches exchange messages, BPDUs are used to calculate the STP topology, and determine the network communication route. A BPDU filter is often used to screen sending or receiving BPDUs on a specific port of the switch.

BPDU Guard

BPDU Guard is a protection mechanism that prevents a port from receiving BPDUs. When an RSTP-enabled port receives BPDUs, it will automatically be in the error-disable state, which means the port will in turn switch to Block state. When STP is enabled, all ports are involved in the STP domain, sending and receiving BPDUs. However, when BPDU Guard is enabled, all ports will not receive or send any BPDUs, as all computers and unmanaged switches do not support STP. When BPDU Guard is enabled, all communications will be treated as error-disabled, and the related ports will be blocked, therefore no more data will be sent or received, protecting the network from a loop chain.

Root Guard

Root Guard prevents a designated port role from changing to root port role on reception of superior information.

Loop Guard

Loop Guard prevents temporary loops in a network caused by **non-designated ports** changing to the spanning-tree **forwarding** state due to a link failure in the topology.

BPDU Filter

BPDU Filter prevents a port from sending and processing BPDUs. A BPDU filter enabled port cannot transmit any BPDUs and drop all received BPDU either.

Configuring BPDU Filter, BPDU/Root/Loop Guard Settings

First click **Spanning Tree** on the menu and then select the **Guard** tab. Next, click the edit icon on the port you want to configure.

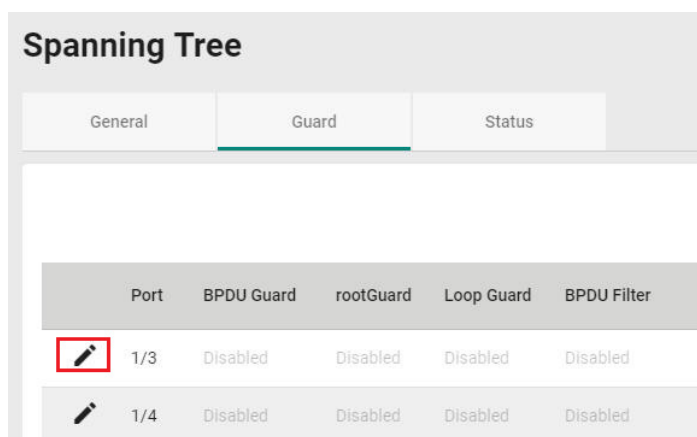

Configure the following settings.

Edit Port 1/3 Setting

BPDU Guard
 Disabled ▼

Root Guard
 Disabled ▼

Loop Guard
 Disabled ▼

BPDU Filter
 Disabled ▼

Copy Config to Ports ▼

Cancel Apply

BPDU Guard

Setting	Description	Factory Default
Enabled	Enable BPDU Guard.	Disabled
Disabled	Disable BPDU Guard.	

NOTE To establish a redundant port e.g. it is highly recommended that you do not enable BPDU filter.

Root Guard

Setting	Description	Factory Default
Enabled	Enable Root Guard.	Disabled
Disabled	Disable Root Guard.	

Loop Guard

Setting	Description	Factory Default
Enabled	Enable Loop Guard.	Disabled
Disabled	Disable Loop Guard.	

BDPU Filter

Setting	Description	Factory Default
Enabled	Enable BPDU Filter.	Disabled
Disabled	Disable BPDU Filter.	

Copy Config to Port

Setting	Description	Factory Default
Select the port(s) from the drop-down list	Copy the same settings to other port(s).	None

When finished, click **Apply** to save your changes.

Viewing Current Spanning Tree Status

Click the **Status** tab to view the current Spanning Tree status.

Spanning Tree

General
Guard
Status

Root Information ↻

Bridge ID
0/00:00:00:00:00:00

Root Path Cost
0

Forward Delay Time
15 (sec)

Hello Time
2 (sec)

Max Age
20 (sec)

Bridge Information ↻

Bridge ID
32768/00:90:E8:00:00:09

Running Protocol
RSTP

Forward Delay Time
15 (sec)

Hello Time
2 (sec)

Max Age
20 (sec)

In addition, the status for each port will also be shown below.

Port	Edge	Port Role	Port State	Root Path Cost	Path Cost	Link Type	BPDU Inconsistency	Root Inconsistency	Loop Inconsistency
1/3	No	Disabled	Disabled	0	20000	Shared-LAN	No	No	No
1/4	No	Disabled	Disabled	0	20000	Shared-LAN	No	No	No
2/1	No	Disabled	Disabled	0	200000000	Shared-LAN	No	No	No
2/2	No	Disabled	Disabled	0	200000000	Shared-LAN	No	No	No
2/3	No	Disabled	Disabled	0	200000000	Shared-LAN	No	No	No
2/4	No	Disabled	Disabled	0	200000000	Shared-LAN	No	No	No
3/1	No	Disabled	Disabled	0	200000000	Shared-LAN	No	No	No
3/2	No	Disabled	Disabled	0	200000000	Shared-LAN	No	No	No
3/3	No	Disabled	Disabled	0	200000000	Shared-LAN	No	No	No

Refer to the following table for detailed description of each item.

Item	Description
Port	The port number on this device.
Edge	Show if this port is connected to an edge device.
Port Rule	Root: The port is connected directly or indirectly to the root device. Designated: The port is designated if it can send the best BPDU on the segment to which it is connected. Alternate: The alternate port receives more useful BPDU from another bridge and is the blocked port. Backup: The backup port receives more useful BPDU from the same bridge and is the blocked port. Disabled: The function is disabled.
Port State	Forwarding: The traffic can be forwarded through this port. Blocked: The traffic will be blocked. Disabled: The function is disabled.
Root Path Cost	The total path cost to the root bridge.
Path Cost	The path cost on this link.
Link Type	Edge Port: The port is connected to an edge device. Point-to-Point Non Edge Port: The port is connected to another bridge and is full duplex. Shared Non Edge Port: The port is connected to another bridge and is half duplex.
BPDU Inconsistency	BPDU is received on a port enabled by a BPDU guard.
Root Inconsistency	A port is changed to a root port when enabled by a loop guard.
Loop Inconsistency	A loop is detected on this port by a loop guard.

Turbo Ring v2

Turbo Ring v2 Overview

Moxa Turbo Ring is a proprietary self-healing technology that enables fast fault recovery of under 20 ms for Fast Ethernet, and 50 ms for Gigabit Ethernet. Turbo Ring supports two topology expansions—ring coupling and dual-ring—to reduce redundant network cabling and network planning costs and to ensure high reliability of your industrial network applications.

The Turbo Ring v2 protocols identify one switch as the **master** of the network, and then automatically block one port beside master on the ring (red line) to avoid network’s redundant loops. In the event that one branch of the ring gets disconnected from the rest of the network, the protocol automatically readjusts the ring so that the part of the network that was disconnected can reestablish contact with the rest of the network.

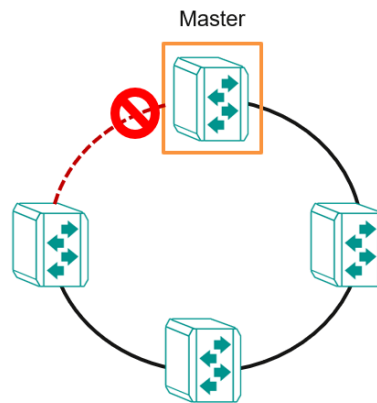

How Turbo Ring v2 Works

Turbo Ring v2 is an advanced technology for network redundancy, which ensures recovery times of less than 20 ms for Fast Ethernet, and 50 ms for Gigabit Ethernet when the network is down. In addition, it allows more switches within the network rings. Users can select different network typologies for Turbo Ring redundancy to allow more network reliability and reduce cabling costs. Below are three examples of how Turbo Ring v2 works.

Ring Coupling

Ring Coupling helps users separate distributed devices into different smaller redundant rings, but in such a way that the smaller rings at different remote sites will be able to communicate with each other. This is useful for applications where some devices are located at remote sites.

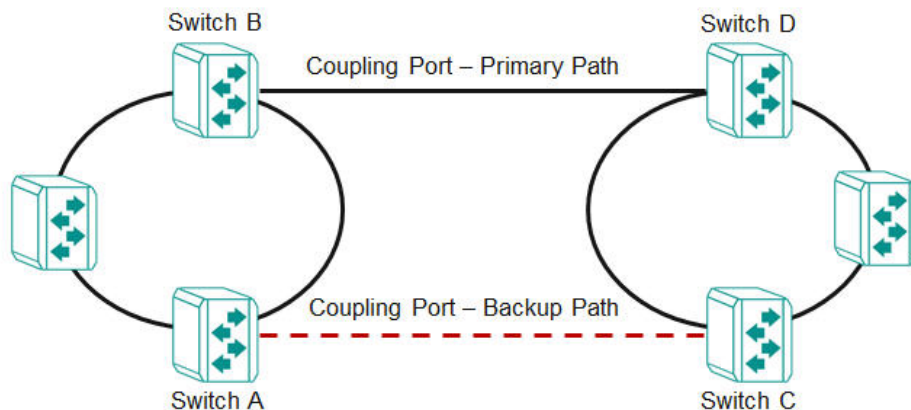

Dual-Ring

Dual-Ring adds reliability by using a single Moxa switch to connect two separate rings for applications that present cabling difficulties. It provides another ring coupling configuration where two adjacent rings can share one switch. This typology is an ideal solution for applications that have inherent cabling difficulties.

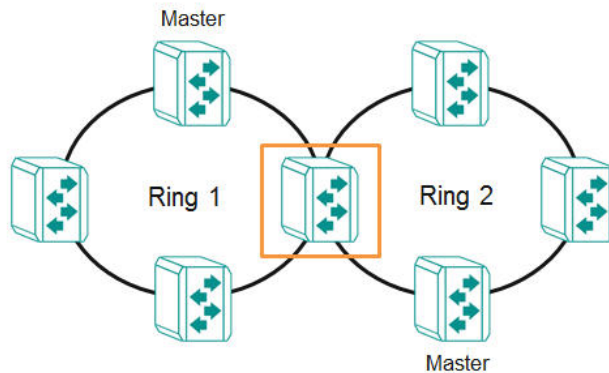

How to Determine the Redundant Path

For Turbo Ring v2, the master is determined by two methods, one is a system MAC address election, the smallest MAC address will play the Master role; the other is user manual configuration to enable Master role on the switch.

The redundant path is determined by "Ring Port 2", which means the port set on "Ring Port 2" will become the blocking port.

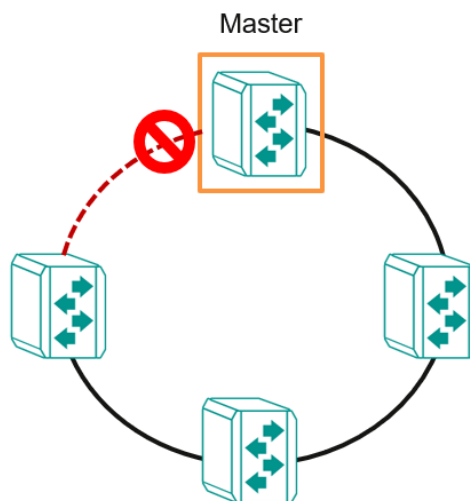

Ring Coupling for a "Turbo Ring V2" Ring

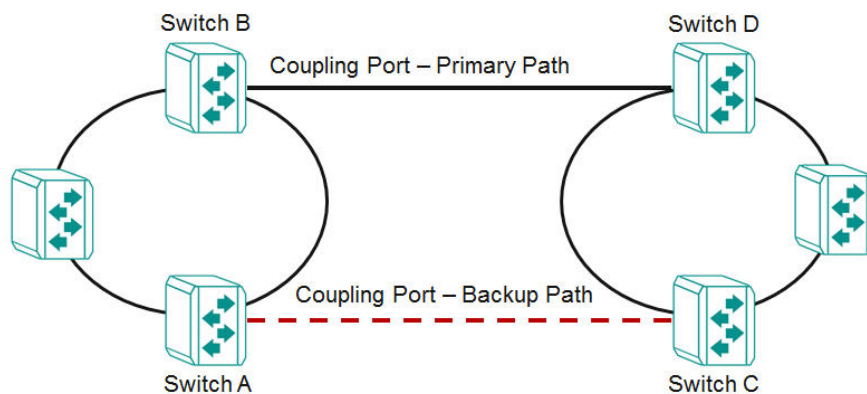

For Turbo Ring V2, Ring Coupling is enabled by configuring the **Coupling Port (Primary)** on Switch B, and the **Coupling Port (Backup)** on Switch A only.

The **Coupling Port (Backup)** on Switch A is used for the backup path, and connects directly to an extra network port on Switch C. The **Coupling Port (Primary)** on Switch B monitors the status of the main path, and connects directly to an extra network port on Switch D. With ring coupling has been established, Switch A can activate the backup path as soon as it detects a problem with the main path.



ATTENTION

Ring Coupling needs to be enabled on one coupling primary switch and one coupling backup switch as the Ring Coupler. The Coupler must designate different ports as the two Turbo Ring ports and the coupling port.

NOTE You do not need to use the same switch for both Ring Coupling and Ring Master.

Turbo Ring V2 Settings and Status

Click **Turbo Ring V2** on the menu, and then select the **Setting** tab.

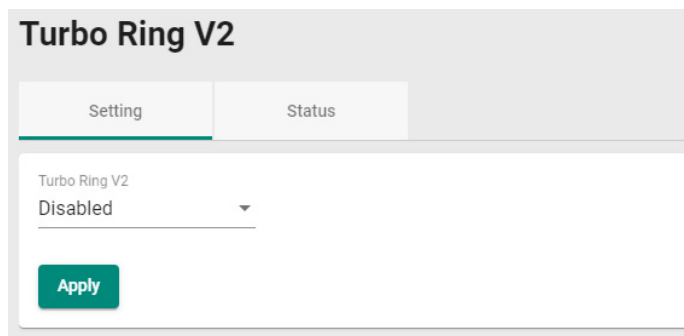

Configure the following setting.

Enable



Setting	Description	Factory Default
Enabled	Enable Turbo Ring V2.	Disabled
Disabled	Disable Turbo Ring V2.	

When finished, click **Apply** to save your changes.

Ring Settings

In **Ring Setting**, click the edit icon.

Ring Setting

	Ring ID	Enabled	Master	Ring Port 1	Ring Port 2
	Ring 1	Disabled	Disabled	2/2	2/3
	Ring 2	Disabled	Disabled	3/4	1/3

Configure the following settings. When finished, click **Apply** to save your changes.

Ring 1 Setting

Enabled
 Disabled ▼

Master
 Disabled ▼

Ring Port 1
 1/1 ▼

Ring Port 2
 2/2 ▼

Cancel **Apply**

Enable

Setting	Description	Factory Default
Enabled	Enable Ring Setting.	Disabled
Disabled	Disable Ring Setting.	

Master

Setting	Description	Factory Default
Enabled	Enable this Ring as the Master.	Disabled
Disabled	Disable this Ring as the Master.	

Ring Port 1

Setting	Description	Factory Default
Select the port from the list	Specify this port as the 1 st redundant port.	1/1

Ring Port 2

Setting	Description	Factory Default
Select the port from the list	Specify this port as the 2 nd redundant port.	1/2

Ring Coupling Overview

Ring Coupling helps users separate distributed devices into different smaller redundant rings, but in such a way that the smaller rings at different remote sites will be able to communicate with each other. This is useful for the applications where some devices are located at remote sites.

Ring Coupling Settings and Status

In the **Ring Coupling Setting**, click the edit icon.

Ring Coupling Setting

Coupling Mode	Enabled	Coupling Port
 Primary Path	Disabled	2/1

Configure the following settings.

Ring Coupling Setting

Enabled
 Disabled ▼

Coupling Mode
 Coupling Primary Path ▼

Coupling Port
 2/1 ▼

Cancel

Apply

Enable

Setting	Description	Factory Default
Enabled	Enable Ring Coupling.	Disabled
Disabled	Disable Ring Coupling.	

Coupling Mode

Setting	Description	Factory Default
Coupling Backup Path	Select Coupling Mode to assign the coupling port as the backup path.	Coupling Primary Path
Coupling Primary Path	Select Coupling Mode to assign the coupling port as the primary path.	

Coupling Port

Setting	Description	Factory Default
Select the port from the list	Select the port as the coupling port.	2/1

When finished, click **Apply** to save your changes.

Ring Settings and Ring Coupling Setting Status

Click **Status** in the Turbo Ring V2 menu to view the current Ring settings and the Ring Coupling Status.

Turbo Ring V2

Setting

Status

Ring Status

Ring ID	Master ID	Status	Master	Ring Port 1	Ring Port 2
Ring 1	00:00:00:00:00:00	Disabled	Slave	Disabled	Disabled
Ring 2	00:00:00:00:00:00	Disabled	Slave	Disabled	Disabled

Ring Coupling Status

Coupling Mode	Coupling Port
Disabled	Disabled

Refer to the following table for a detailed description for each item of the Ring status.

Item	Description
Ring ID	The ID number of the Ring.
Master ID	The MAC address of the Ring Master.
Status	Healthy: The Ring and the ports are working properly. Break: One or more Rings have been broken.
Master	The device is Master/Slave on this Ring.
Ring Port 1	The port of the first Ring port.
Ring Port 2	The port of the second Ring port.

Refer to the following table for a detailed description for the status of Coupling Mode and Coupling Port.

Item	Description
Coupling Mode	Primary: The main path of Ring Coupling. Backup: The backup path of Ring Coupling.
Coupling Port	The port of the Ring Coupling.

Turbo Chain

Turbo Chain Overview

Moxa's Turbo Chain is an advanced software technology that gives network administrators the flexibility of constructing any type of redundant network topology. In addition, it offers system recovery time under 20 ms for Fast Ethernet, and 50 ms for Gigabit Ethernet for member port link environments. When using the "chain" concept, you first connect the Ethernet switches in a chain and then simply link the two ends of the chain to an Ethernet network.

Turbo Chain can be used on industrial networks that have a complex topology. If the industrial network uses a multi-ring architecture, Turbo Chain can be used to create flexible and scalable topologies with a fast media-recovery time.

How Turbo Chain Works

Moxa's Turbo Chain outperforms traditional ring topologies by providing great flexibility, unrestricted expansion, and cost-effective configurations when connecting separate redundant rings together—in a simplified manner. With Turbo Chain, you can create any complex redundant network that correspond to your needs, while still ensuring great reliability and availability for your industrial Ethernet network applications.

With Moxa's Turbo Chain, network engineers have the flexibility to construct any type of redundant topology with minimum effort—by simply linking Turbo Chain to the Ethernet Network. Turbo Chain allows for unrestricted network expansion. Network engineers no longer need to go through the hassle of reconfiguring the existing network, and can simply use Turbo Chain to scale up their redundant networks.

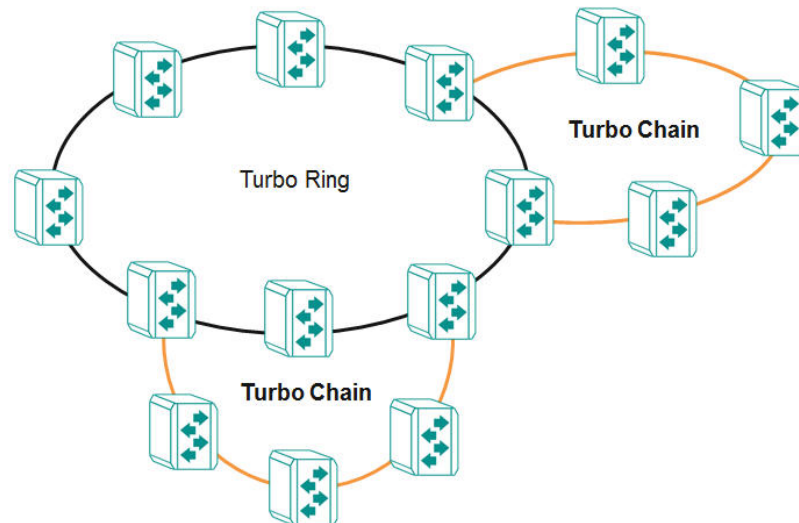

How to Determine the Redundant Path

Here is an example of how to set up Turbo Chain and determine the redundant path.

1. Select the Head switch, Tail switch, and Member switches.
2. Configure one port as the Head port and one port as the Member port in the Head switch, configure one port as the Tail port and one port as the Member port in the Tail switch, and configure two ports as Member ports in each of the Member switches.
3. Connect the Head switch, Tail switch, and Member switches as shown in the diagram below.

The path connecting to the Head port is the main path, and the path connecting to the Tail port is the backup path of Turbo Chain. Under normal conditions, packets are transmitted through the Head Port to the LAN network. If any Turbo Chain path is disconnected, the Tail Port will be activated so that packet transmission can continue.

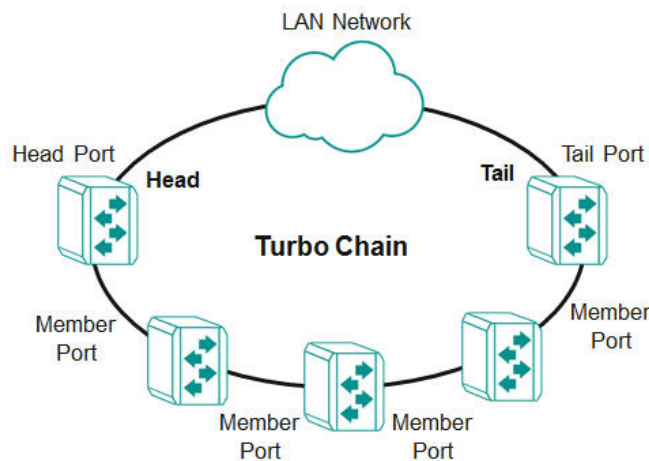

There are two points to note:

1. Two Chain ports must have the same PVID.
2. Chain ports must join the untagged members of PVID VLAN before being assigned to be a Chain port.

Turbo Chain V2 Settings and Status

First select **Turbo Chain** on the menu and then click **Setting**.

Turbo Chain

Setting	Status
Enable	Disabled
Chain Role	Member
Member Port 1	1/1
Member Port 2	2/3

Apply

Configure the following settings.

Enable

Setting	Description	Factory Default
Enabled	Enable Turbo Chain.	Disabled
Disabled	Disable Turbo Chain.	

Chain Role

Setting	Description	Factory Default
Head	Enable chain role as the Head.	Member
Member	Enable chain role as a Member.	
Tail	Enable chain role as the Tail.	

Head/Member/Tail Port

Setting	Description	Factory Default
Select the port from the list	Specify the port as the Head/Member/Tail port.	1/1

Member Port

Setting	Description	Factory Default
Select the port from the list	Specify the port as the member port.	1/2

When finished, click **Apply** to save your changes.

Select **Turbo Chain** on the menu and click **Status** to view the current Turbo Chain status.

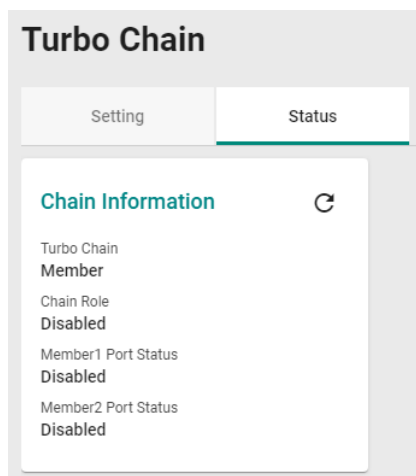

Refer to the following table for a detailed description of each item.

Item	Description
Turbo Chain	Head: The device is the head of this chain. Member: The device is a member of this chain. Tail: The device is the tail of this chain.
Chain Role	Healthy: The Chain and the ports are working properly. Break: The chain or the ports are broken.
Head/Member/Tail 1 Port Status	The status of the first Head/Member/Tail port.
Head/Member/Tail 2 Port Status	The status of the second Head/Member/Tail port.

Dual Homing

Dual Homing Overview

Dual Homing is a layer 2 function, which uses a single Ethernet switch to connect two network topologies, both of which can run any redundancy protocols. It involves coupling two separate devices or even coupling to two separate rings with a single switch connecting to two independent connection points. The secondary path will be activated if the primary path fails.

How Dual Homing Works

Dual Homing is a redundant path technology that allows a single switch to connect to any topology.

The primary and secondary paths require manual configuration: Select a primary port as the primary path and the secondary port as the secondary path. The default path switching mode is "primary path always first", which means when failover occurs, the primary path will switch to the secondary path, but if the primary path recovers, the path will switch back to the primary path again even if the secondary path is healthy.

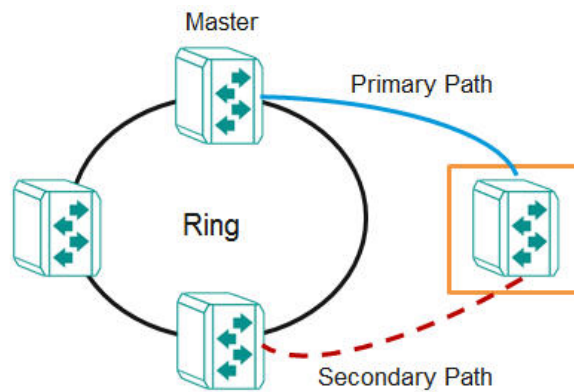

Path Switching Mode

There are two path switch modes that users can configure:

Primary path always first: Always selects the path switching mode as the primary path first. When path switching occurs, the primary path will always be the first path for data communication.

Maintain current path: Select the path switching mode to maintain the current path. When path switching occurs, maintain the current path to keep the network stable and do not change paths for data communication.

Dual Homing Settings and Status

Click **Dual Homing** in the menu and select **Setting**.

Dual Homing

Setting

Status

Dual Homing
Disabled ▾

Primary Port
1/1 ▾

Secondary Port
2/4 ▾ i

Path Switching Mode
Primary path always ... ▾

Apply

Configure the following settings.

Enable

Setting	Description	Factory Default
Enabled	Enable Dual Homing.	Disabled
Disabled	Disable Dual Homing.	

Primary Port

Setting	Description	Factory Default
Select the port from the list	Specify the port as the primary port.	1/1

Secondary Port

Setting	Description	Factory Default
Select the port from the list	Specify the port as the secondary port.	1/1

Path Switching Mode

Setting	Description	Factory Default
Primary path always first	Always selects path switching mode as the primary path first.	Primary path always first
Maintain current path	Always selects the path switching mode to maintain the current path.	

When finished, click **Apply** to save your changes.

First, click **Dual Homing** in the menu and then select **Status** to view the current Dual Homing Settings.

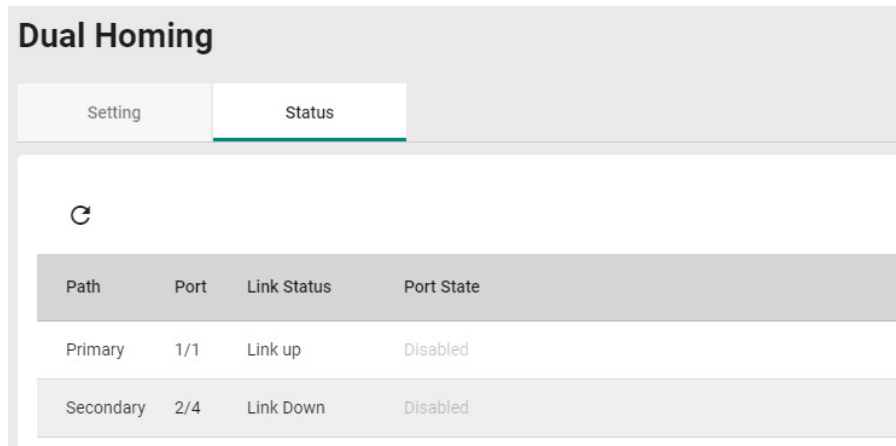

Refer to the following table for a detailed description of each item.

Item	Description
Path	Primary: The primary path of dual homing. Secondary: The secondary path of dual homing.
Port	The port that is used as the primary/secondary path.
Link Status	Link Up: The port is connected. Link Down: The port is disconnected.
Port State	Forwarding: The port is forwarding traffic. Blocking: The port is blocking traffic.

Management

This section describes how to configure **Network Management** including **SNMP** and **SNMP Trap/Inform**.

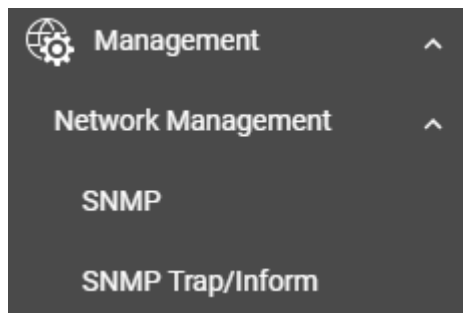

Network Management

This section demonstrates how to configure SNMP and SNMP Trap/Inform settings.

SNMP

Moxa switches support SNMP V1, V2c, and V3. SNMP V1 and SNMP V2c use a community string match for authentication, which means that SNMP servers access all objects with read-only or read/write permissions using the community strings *public* and *private* by default. SNMP V3 requires that you select an authentication level of MD5 or SHA. You can also enable data encryption to enhance data security.

Supported SNMP security modes and levels are shown in the table below. Select the security mode and level that will be used to communicate between the SNMP agent and manager.

Protocol Version	UI Setting	Authentication	Encryption	Method
SNMP V1, V2c	V1, V2c Read Community	Community string	No	Uses a community string match for authentication.
	V1, V2c Write/Read Community	Community string	No	Uses a community string match for authentication.
SNMP V3	None	No	No	Uses an account with admin or user to access objects.
	MD5 or SHA	Authentication based on MD5 or SHA	Disabled	Uses authentication based on HMAC-MD5, or HMAC-SHA algorithms. 8-character passwords are the minimum requirement for authentication.
	MD5 or SHA	Authentication based on MD5 or SHA	Data encryption key: DES, AES	Uses authentication based on HMAC-MD5 or HMAC-SHA algorithms, and data encryption key. 8-character passwords and a data encryption key are the minimum requirements for authentication and encryption.

General Settings

First click **SNMP** on the menu and then click **General**.

Configure the following settings.

SNMP Version

Setting	Description	Factory Default
V1, V2c, V3	Specify V1, V2c, and V3 as the SNMP version.	V1, V2c
V1, V2c	Specify V1 and V2c as the SNMP version.	
V3 only	Specify V3 as the SNMP version.	

Read Community

Setting	Description	Factory Default
Max. 30 characters	Specifies the community string to authenticate the SNMP agent for read-only access. The SNMP agent will access all objects with read-only permissions using this community string.	public

Read/Write Community

Setting	Description	Factory Default
Max. 30 characters	Specifies the community string to authenticate the SNMP agent for read/write access. The SNMP server will access all objects with read/write permissions using this community string.	private

When finished, click **Apply** to save your changes.

Creating an SNMP Account

Click **SNMP** on the menu and then click the **SNMP Account**. Next click the **+** icon on the page.

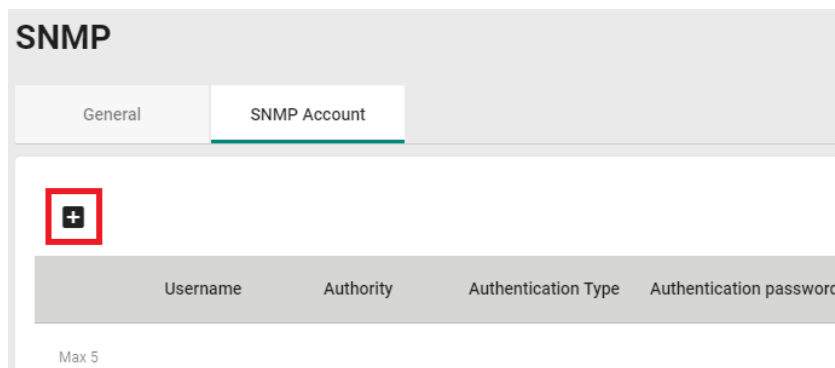

Configure the following settings.

Create SNMP Account Setting

Username

At least 4 characters 0 / 32

Authority

Read Write

Authentication Type

None

Encryption Method

Disabled

Cancel

Create

Username

Setting	Description	Factory Default
At least 4 characters, (max. 32 characters)	Input a username.	None

Authority

Setting	Description	Factory Default
Read Write	The user has read/write access.	None
Read Only	The user only has read access.	

Authentication type

Setting	Description	Factory Default
None	No authentication will be used.	None
MD5	MD5 is the authentication type.	
SHA	SHA is the authentication type.	

Authentication password

Setting	Description	Factory Default
8 to 64 characters	Input the authentication password.	None

Encryption Method

Setting	Description	Factory Default
Disabled	Disable the encryption method.	None
DES	DES is the encryption method.	
AES	AES is the encryption method.	

Encryption Key

Setting	Description	Factory Default
8 to 30 characters	Enable data encryption.	None

When finished, click **Create**.

Deleting an Existing SNMP Account

To delete an existing SNMP account, select the delete icon on the account.

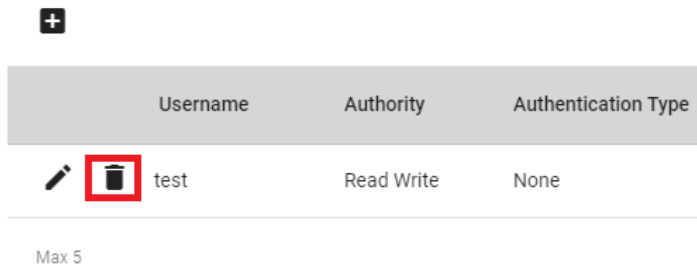

Click **Delete** to delete the SNMP account.

Delete Account

Are you sure you want to delete the selected account?



SNMP Trap/Inform

General Settings

First select **SNMP Trap/Inform** on the menu and then click **General**.

Configure the following settings.

Retry

Setting	Description	Factory Default
1 to 99	Input the retry value.	3

Timeout

Setting	Description	Factory Default
1 to 300	Input the timeout value.	10

When finished, click **Apply** to save your changes.

SNMP Trap Host Settings

SNMP Trap allows an SNMP agent to notify the NMS of a significant event. The switch supports two SNMP modes: **Trap** mode and **Inform** mode. Click **SNMP Trap/Inform** on the menu, and then click **SNMP Trap Host**. Then select the + icon on the page.

Configure the following settings.

Create Host Setting

Host IP/Name *

 0 / 32

Mode *

Trap Community *
 At least 4 characters 0 / 32

Cancel

Create

Host IP/Name

Setting	Description	Factory Default
Input a host IP or name, (max. 32 characters)	Specify the name of the primary trap server used by your network.	None

Mode

Setting	Description	Factory Default
Trap V1	Set the trap version to Trap V1.	None
Trap V2c	Set the trap version to Trap v2c.	
Inform V2c	Set the inform version to Inform V2c.	
Trap V3	Set the trap version to Trap V3.	
Inform V3	Set the inform version to Inform V3.	

Trap Community

Setting	Description	Factory Default
At least 4 characters, (max. 30 characters)	Specify the community string that will be used for authentication.	None

When finished, click **Create**.

SNMP Trap Account Settings

Click **SNMP Trap/Inform** on the menu, and then click **SNMP Trap Account**. Next click the + icon on the page.

SNMP Trap/Inform

General

SNMP Trap Host

SNMP Trap Account

+

Username	Authentication Type	Authentication password	Encryption Method
Max 1			

Configure the following settings

Create SNMP Trap Account Setting

Username ^{*}

At least 4 characters 0 / 32

Authentication Type
 None ▾

Encryption Method
 Disabled ▾

Cancel

Create

Username

Setting	Description	Factory Default
At least 4 characters, (max. 30 characters)	Input a username.	None

Authentication type

Setting	Description	Factory Default
None	No authentication type will be used.	None
MD5	MD5 is the authentication type.	
SHA	SHA is the authentication type.	

Authentication Password

Setting	Description	Factory Default
8 to 64 characters	Input the authentication password.	None

Encryption Method

Setting	Description	Factory Default
Disabled	Disable the encryption method.	None
DES	DES is the encryption method.	
AES	AES is the encryption method.	

Encryption Key

Setting	Description	Factory Default
8 to 64 characters	Enable data encryption.	None

When finished, click **Create**.

Security

This section describes how to configure **Device Security**, **Network Security**, and **Authentication**.

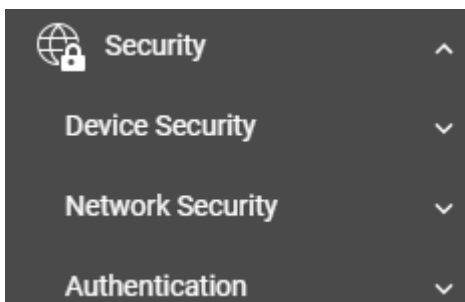

Device Security

This section includes information about the **Management Interface**, **Login Policy**, **Trusted Access**, and **SSH & SSL** configurations.

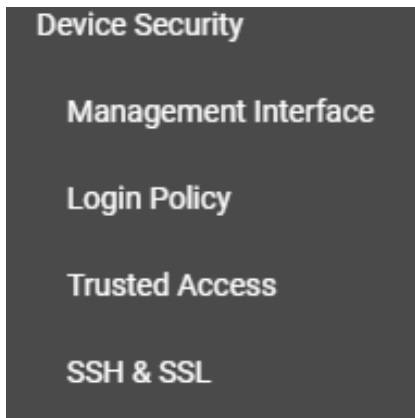

Management Interface

Click **Management Interface** on the menu.

Management Interface

HTTP	HTTP - TCP Port *
Enabled ▼	<input type="text" value="80"/>
HTTPS	HTTPS - TCP Port *
Enabled ▼	<input type="text" value="443"/>
Telnet	Telnet - TCP Port *
Enabled ▼	<input type="text" value="23"/>
SSH	SSH - TCP Port *
Enabled ▼	<input type="text" value="22"/>
SNMP	SNMP - UDP Port *
Enabled ▼	<input type="text" value="161"/>
Moxa Service(Encrypted) - TCP ...	Moxa Service(Encrypted) - UDP ...
<input type="text" value="443"/>	<input type="text" value="40404"/>
Maximum number of Login Ses...	
<input type="text" value="5"/>	
1 - 10	
Maximum number of Login Ses...	
<input type="text" value="1"/>	
1 - 5	
Apply	

Configure the following settings.

HTTP

Setting	Description	Factory Default
Enabled	Enable the HTTP connection.	Enabled
Disabled	Disable the HTTP connection.	

HTTP – TCP Port

Setting	Description	Factory Default
0 to 47808	Specify the HTTP connection port number.	80

HTTPS

Setting	Description	Factory Default
Enabled	Enable the HTTPS connection.	Enabled
Disabled	Disable the HTTPS connection.	

HTTPS – TCP Port

Setting	Description	Factory Default
1 to 65535	Specify the HTTP connection port number.	443

Telnet

Setting	Description	Factory Default
Enabled	Enable a Telnet connection.	Enabled
Disabled	Disable a Telnet connection.	

Telnet – TCP Port

Setting	Description	Factory Default
1 to 65535	Specify the Telnet connection port number.	23

SSH

Setting	Description	Factory Default
Enabled	Enable the SSH connection.	Enabled
Disabled	Disable the SSH connection.	

SSH – TCP Port

Setting	Description	Factory Default
1 to 65535	Input the SSH connection port number.	22

SNMP

Setting	Description	Factory Default
Enabled	Enable the SNMP connection.	Enabled
Disabled	Disable the SNMP connection.	

SNMP – Port

Setting	Description	Factory Default
0 to 47808	Input the SNMP connection port number.	161

Moxa Service

Setting	Description	Factory Default
Enabled	Enable Moxa Service.	Enabled
Disabled	Disable Moxa Service.	

NOTE Moxa Service is only for Moxa network management software suite.

Moxa Service (Encrypted) – TCP Port

Setting	Description	Factory Default
443 (read only)	Enable a Moxa Service TCP port.	443

Moxa Service (Encrypted) – UDP Port

Setting	Description	Factory Default
40404 (read only)	Enable a Moxa Service UDP port.	40404

Maximum number of Login Sessions for HTTP

Setting	Description	Factory Default
1 to 10	Specify the maximum amount of HTTP login sessions that can happen at the same time.	5

Maximum number of Login Sessions for Telnet

Setting	Description	Factory Default
1 to 5	Specify the maximum amount of Telnet login sessions that can happen at the same time.	1

When finished, click **Apply** to save your changes.

Login Policy

Click **Login Policy** on the menu.

Login Policy

Login Message 0 / 500

Login Authentication Failure Message. 0 / 500

Account Login Failure Lockout
 Disabled ▼

Retry Failure Threshold *
 5
 1 - 10 times

Lockout Time *
 5
 1 - 10 min

Auto Logout Setting *
 5
 0 - 1440 min

Apply

Configure the following settings.

Login Message

Setting	Description	Factory Default
0 to 500 characters	Input the message that will be displayed to users when they log in.	None

Login Authentication Failure Message

Setting	Description	Factory Default
0 to 500 characters	Input the message that will be displayed when users fail to log in.	None

Account Login Failure Lockout

Setting	Description	Factory Default
Enabled	Enable the lockout function when a user fails to log in.	Disabled
Disabled	Disable the lockout function when a user fails to log in.	

Retry Failure Threshold (times)

Setting	Description	Factory Default
1 to 10	Input the maximum number of retry failure times.	5

Lockout Time (min.)

Setting	Description	Factory Default
1 to 60	Specify the amount of times log in credentials can be entered incorrectly before the user is logged out.	5

Auto Logout Setting (min.)

Setting	Description	Factory Default
0 to 1440	Specify how long a user has to be inactive before getting logged out.	5

When finished, click **Apply** to save your changes.

Trusted Access

Trusted Access Overview

Trusted Access is a mechanism that provides a secure connection to Moxa’s switch. Users can use this method to allow the connection from the assigned IP address to ensure safe data transmission.

Trusted Access Settings and Status

Click **Trusted Access** on the menu.

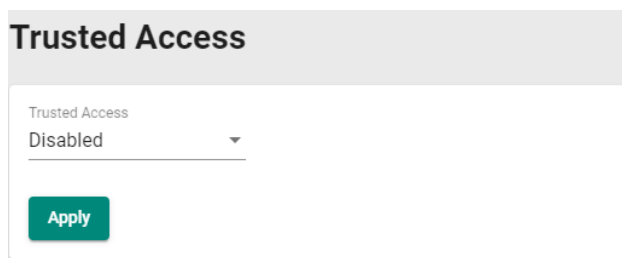

Configure the following settings.

Enable

Setting	Description	Factory Default
Enabled	Enable Trusted Access.	Disabled
Disabled	Disable Trusted Access.	

NOTE

1. Trusted Access has to be added before it can be enabled.
2. In order to avoid being disconnected after you enable Trusted Access, you must first add the current IP subnet to Trusted Access. In order to use this function, you should use an RS-232 console to log in or set the device to factory default.

When finished, click **Apply** to save your changes.

Next, click the + icon.

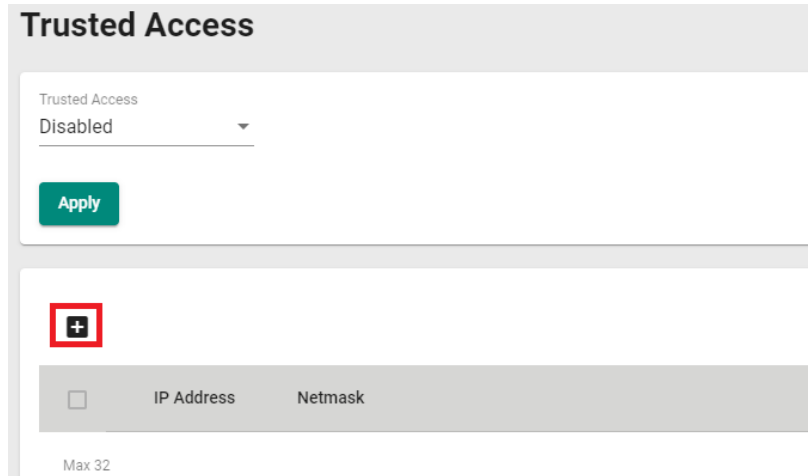

Configure the following settings.

IP Address

Setting	Description	Factory Default
Input IP address	Specify the IP address that is allowed to connect to Moxa’s switch.	None

Netmask

Setting	Description	Factory Default
Input Netmask	Specify the Netmask that is allowed to connect to Moxa’s switch.	None

When finished, click **Create**.

You can view the Trusted Access status on the figure below.

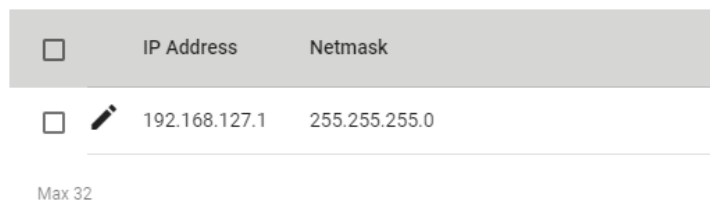

To delete the trusted access source, select the item and then click the delete icon on the top of the page.

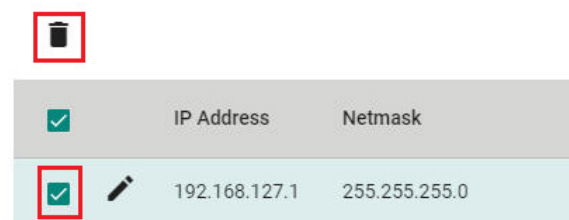

Click **Delete** to delete the item.

Delete Entry

Are you sure you want to delete the selected entry?



SSH & SSL

SSH Key Regeneration

Click **SSH & SSL** on the menu and then select the **SSH** tab.

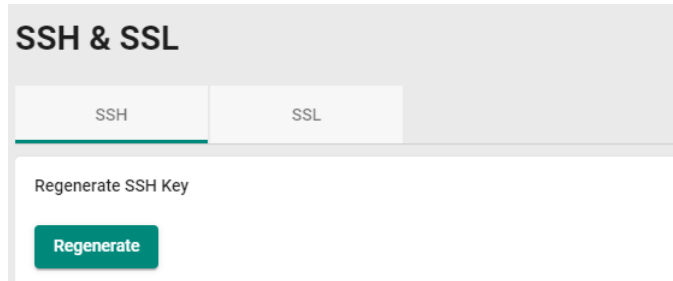

Click **Regenerate** to regenerate the key.

SSL Certification Regeneration

Click **SSH & SSL** on the menu and select the **SSL** tab. The Certificate Information is shown on this screen.

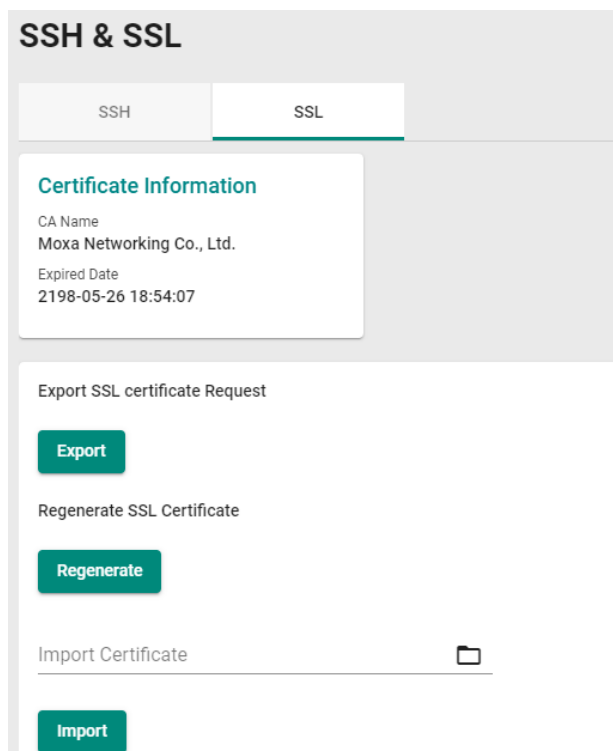

Configure the following settings.

Export SSL Certificate Request

Setting	Description	Factory Default
Export	Export the SSL certificate to your local computer.	None

Regenerate SSL Certificate

Setting	Description	Factory Default
Regenerate	Regenerate the SSL certificate.	None

Import Certificate

Setting	Description	Factory Default
Select the file	Import the SSL certificate from the location where the SSL certificate is located.	None

Network Security

This section demonstrates how to configure network security settings, including **IEEE802.1X**, **Port Security**, and **Traffic Storm Control**.

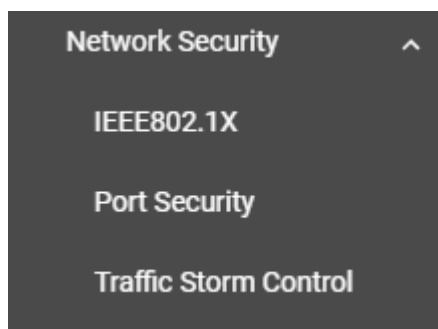

IEEE 802.1X

Port-based IEEE 802.1X Overview

The IEEE 802.1X standard defines a protocol for client/server-based access control and authentication. The protocol restricts unauthorized clients from connecting to a LAN through ports that are open to the Internet, and which otherwise would be readily accessible. The purpose of the authentication server is to check each client that requests access to the port. The client is only allowed access to the port if the client's permission is authenticated.

Three components are used to create an authentication mechanism based on 802.1X standards: Client/Supplicant, Authentication Server, and Authenticator.

Client/Supplicant: The end station that requests access to the LAN and switch services and responds to the requests from the switch.

Authentication Server: The server that performs the actual authentication of the supplicant.

Authenticator: Edge switch or wireless access point that acts as a proxy between the supplicant and the authentication server, requesting identity information from the supplicant, verifying the information with the authentication server, and relaying a response to the supplicant.

The Moxa switch acts as an authenticator in the 802.1X environment. A supplicant and an authenticator exchange EAPOL (Extensible Authentication Protocol over LAN) frames with each other. We can either use an external RADIUS server as the authentication server or implement the authentication server in the Moxa switch by using a Local User Database as the authentication look-up table. When we use an external RADIUS server as the authentication server, the authenticator and the authentication server exchange EAP frames.

Authentication can be initiated either by the supplicant or the authenticator. When the supplicant initiates the authentication process, it sends an **EAPOL-Start** frame to the authenticator. When the authenticator initiates the authentication process or when it receives an **EAPOL Start** frame, it sends an **EAP Request/Identity** frame to ask for the username of the supplicant.

How IEEE 802.1X Works

802.1X authentication requires three parties: a supplicant, an authenticator, and an authentication server. The supplicant is a client device that wishes to connect to the LAN or WLAN. The supplicant can also use the software to run on the client that offers credentials to the authenticator. Network administrators usually use an Ethernet switch or wireless access point as the authenticator, and running software supporting RADIUS and EAP protocols in the authentication server.

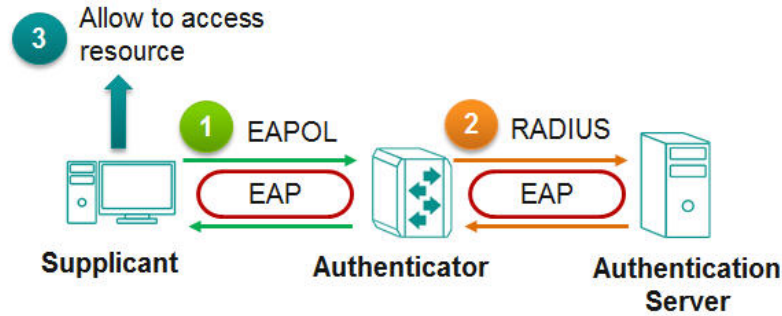

The authenticator serves as a security guard to a protected network. The supplicant is not allowed access through the authenticator to the protected side of the network unless the supplicant’s identity has been validated and authorized. With 802.1X port-based authentication, the supplicant provides credentials, such as user name/password or digital certificate, to the authenticator, and the authenticator transmits the credentials to the authentication server for verification. If the authentication server approves the credentials as valid, the supplicant (client device) is allowed to access resources located on the protected side of the network.

IEEE 802.1X Settings

Click **IEEE802.1X** on the menu and then select the **General** tab.

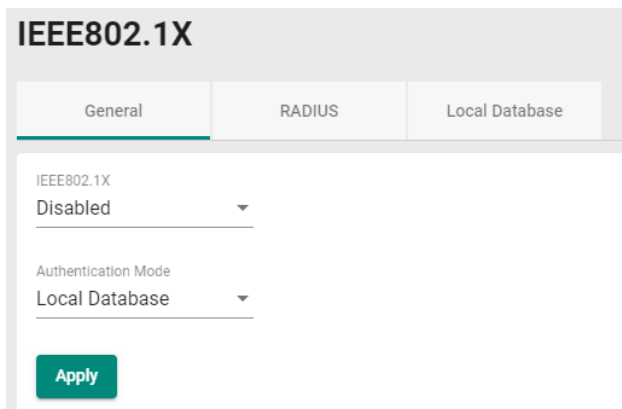

Configure the following settings.

Enable





Setting	Description	Factory Default
Enabled	Enable IEEE 802.1X.	Disabled
Disabled	Disable IEEE 802.1X.	

Authentication Mode

Setting	Description	Factory Default
Local Database	Use the local database as the authentication mode.	Local Database
RADIUS	Use the RADIUS as the authentication mode.	

When finished, click **Apply** to save your changes.

To configure the IEEE 802.1X settings for the specific port, click the edit icon on the port.

	Port	Enable	Port Control	Max Request	Query Period	Reauthentication
	1/1	Disabled	Authorized	2	60	Disabled
	1/2	Disabled	Authorized	2	60	Disabled
	1/3	Disabled	Authorized	2	60	Disabled
	1/4	Disabled	Authorized	2	60	Disabled

Configure the following settings.

Port 1/1 Setting

Enabled
 Disabled

Port Control
 Force Authorized

Max Request * 1 - 10 times

Quiet Period * 0 - 65535 sec

Reauthentication Disabled

Reauth Period * 1 - 65535 sec

Server Timeout * 1 - 65535 sec

Supp Timeout * 1 - 65535 sec

Tx Period * 1 - 65535 sec

Copy Config to Ports 

Cancel

Enable

Setting	Description	Factory Default
Enabled	Enable IEEE 802.1X.	Disabled
Disabled	Disable IEEE 802.1X.	

Port Control

Setting	Description	Factory Default
Force Unauthorized	The controlled port has to be held in the Unauthorized state.	Auto
Auto	The controlled port is set to the authorized or unauthorized state in accordance with the outcome of an authentication exchange between the Supplicant and the Authentication Server.	
Force Authorized	The controlled port is required to be held in the authorized state.	

Max Request (times)

Setting	Description	Factory Default
1 to 10	Enable re-authentication request time.	2

Quiet Period (sec.)

Setting	Description	Factory Default
0 to 65535	Specify the duration of time that the switch remains in the quiet state following a failed authentication exchange with the client.	60

Reauthentication

Setting	Description	Factory Default
Enabled	Enable re-authentication.	Disabled
Disabled	Disable re-authentication.	

Reauth Period (sec.)

Setting	Description	Factory Default
1 to 65535	Input the duration of time between re-authentication attempts.	3600

Server Timeout (sec.)

Setting	Description	Factory Default
1 to 65535	Input the duration of time that the switch will re-transmit the packets from the switch to the authentication server.	30

Supp (Supplicant, such as Client PC) Timeout (sec.)

Setting	Description	Factory Default
1 to 65535	Input the duration of time that the switch will re-transmit the packets from the switch to the client.	30

Tx Period (sec.)

Setting	Description	Factory Default
1 to 65535	Input the duration of time that the switch will re-transmit the data to the client.	30

Copy Config to Ports

Setting	Description	Factory Default
Select the port(s) from the drop-down list	Allows users to copy configurations to other port(s).	None

When finished, click **Apply** to save your changes.

IEEE 802.1X Database

RADIUS

RADIUS **Remote Authentication Dial in User Service** is a protocol that involves three services in one network protocol: Authentication, Authorization, and Accounting (AAA). The protocol operates on port 1812, and the AAA management for users connecting to a network service.

RADIUS is based on a client/server protocol that runs in the application layer, and can use either TCP or UDP as the mode of transport. The network access servers that contain the RADIUS protocol can allow the client to communicate with the RADIUS server. Through Authentication, Authorization, and Accounting, RADIUS is used to monitor access to the network.

To configure RADIUS settings, click the **RADIUS** tab.

Configure the following settings.

Server Address 1

Setting	Description	Factory Default
To input server address 1	Specify the 1 st server address.	None

Auth Port

Setting	Description	Factory Default
1 to 65535	Specify the authentication port number for the 1 st server address.	None

Share Key

Setting	Description	Factory Default
Input the share key for the 1 st server, (0 to 46)	Specify the share key for the 1 st server.	None

Timeout (sec.)

Setting	Description	Factory Default
1 to 120	Specify the duration of time before a device is logged out.	None

Retransmit (sec.)

Setting	Description	Factory Default
1 to 254	Specify the time for data re-transmission.	None

Server Address 2

Setting	Description	Factory Default
To input server address 2	Specify the 2 nd server address.	None

Auth Port

Setting	Description	Factory Default
1 to 65535	Specify the authentication port number for the 1 st server address.	None

Share Key

Setting	Description	Factory Default
Input the share key for the 2 nd server (0 to 46)	Specify the share key for the 2 nd server.	None

Timeout

Setting	Description	Factory Default
1 to 120	Specify the duration of time before the device is timed out.	None

Retransmit (sec.)

Setting	Description	Factory Default
1 to 254	Specify the time for data re-transmission.	None

When finished, click **Apply** to save your changes.

NOTE The RADIUS service will be operated via the 1st server first; if it fails, it will be run on the 2nd server.

Local Database

First click the **Local Database** tab and then click the + icon.

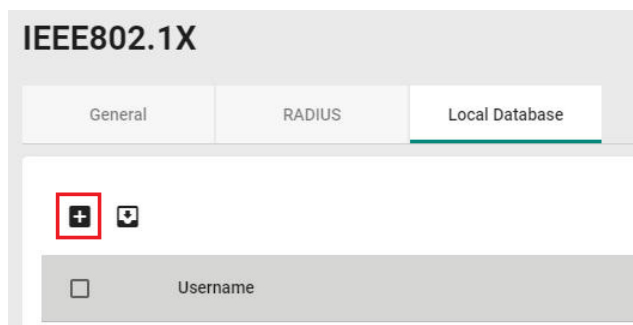

Configure the following settings.

Account Setting

Username

 0 / 20

Password

 At least 4 characters 0 / 64

Confirm Password

 At least 4 characters 0 / 64

Cancel

Apply

Username

Setting	Description	Factory Default
0 to 20 characters	Specify the username for the local database.	None

Password

Setting	Description	Factory Default
At least 4 characters, (max. 64 characters)	Specify the password for the local database user.	None

Confirm Password

Setting	Description	Factory Default
At least 4 characters, (max. 64 characters)	Confirm the password for the local database user.	None

When finished, click **Apply** to save your changes.

Port Security

MAC Sticky Overview

MAC Sticky is a function that allows users to configure the maximum number of MAC addresses (the Limit) that a port can "learn". Users can configure what action should be taken (under Secure Action) when a new MAC address tries to access a port after the maximum number of MAC addresses have already been learned. The total number of allowed MAC addresses cannot exceed 1024.

How MAC Sticky Works

In MAC Sticky mode, administrators can set a proper limit number and then configure trust devices manually, or let the system configure trust devices automatically. Except for dropping packets as a response to any violations, administrators can set 'port shutdown' on a port and achieve a strict security guarantee. When a violation is registered on a port, the port will shut down and an administrator will receive a notification to perform a check.

MAC Sticky Settings and Status

To configure the MAC Sticky settings, select the **General** tab in **Port Security**.

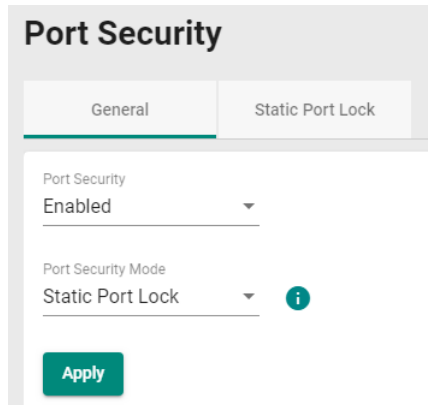

Configure the following settings.

Enable

Setting	Description	Factory Default
Enabled	Enable port security.	Enabled
Disabled	Disable port security.	

Port Security Mode

Setting	Description	Factory Default
MAC Sticky	Specify MAC Sticky as the port security mode.	Static Port Lock
Static Port Lock	Specify Static Port Lock as the port security mode.	

Select **MAC Sticky** and click **Apply**.

NOTE When you change the Port Security Mode, the settings in the table will be deleted.

Click the edit icon on the port you want to edit.

	Port	Enable	Address Limit	Secure Action	Current Address
	1/1	Disabled	1	Packet Drop	0
	1/2	Disabled	1	Packet Drop	0
	1/3	Disabled	1	Packet Drop	0
	1/4	Disabled	1	Packet Drop	0

Configure the following settings.

Edit Port 1/1 Setting

MAC Sticky
 Disabled ▼

Address Limit *
 1 i

1 - 1013

Secure Action
 Packet Drop ▼

Cancel

Apply

MAC Sticky

Setting	Description	Factory Default
Enabled	Enable Static Port Lock for this port.	Disabled
Disabled	Disable Static Port Lock for this port.	

Address Limit

Setting	Description	Factory Default
1 to 997	Specify the maximum numbers of the learned MAC address.	1

Secure Action

Setting	Description	Factory Default
Port Shutdown	Enable port shutdown when a violation occurs.	Packet Drop
Packet Drop	Drop the packets when a violation occurs.	

When finished, click **Apply** to save your changes.

Next, click the **MAC Sticky** tab, and then click the **+** icon to add the MAC Sticky entries.

Port Security

General

MAC Sticky

Port Security Mode
MAC Sticky

Total Trust Hosts
0

System Max. Address
1024

+

↺

+

<input type="checkbox"/>	Port	VLAN	MAC Address	Type

Configure the following settings.

Create Entry

Port * 

VLAN ID *

MAC Address * 

Cancel

Create

Port

Setting	Description	Factory Default
Select the port from the drop-down list	Select the port(s) that will be used with the MAC Sticky function.	None

VLAN ID

Setting	Description	Factory Default
Input the VLAN ID	Specify the VLAN ID that will be used with MAC Sticky.	None

MAC Address

Setting	Description	Factory Default
Input the MAC address that will be used	Specify the MAC Address of the device that will be used as the reliable source for network access.	None

When finished, click **Create**.

You can view the MAC Sticky settings in the figure below.

Port Security



General

MAC Sticky

Port Security Mode
MAC Sticky

Total Trust Hosts
1

System Max. Address
1024

	Port	VLAN	MAC Address	Type	Effective
<input type="checkbox"/>		3/4	1	c8.cb:b8:02:26:5f	Sticky Dynamic Yes

Static Port Lock Overview

To provide a port-based security function, Moxa’s switches have implemented Static Port Lock function; the main idea is to allow configured devices, 128 at most, to access the network through a specific port. Packets sent from unknown devices or from configured devices with mismatching ports will be dropped. In other words, only the packets from the devices pre-configured with the specific MAC addresses can be sent to the specific port to ensure a secured network data transmission scenario.

Static Port Lock Settings and Status

To configure these setting, first click the **Port Security** tab and then click **General**.

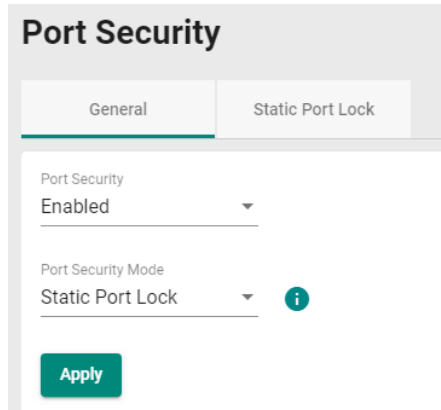

Configure the following settings.

Enable





Setting	Description	Factory Default
Enabled	Enable port security.	Enabled
Disabled	Disable port security.	

Port Security Mode

Setting	Description	Factory Default
MAC Sticky	Select MAC Sticky as the port security mode.	Static Port Lock
Static Port Lock	Select Static Port Lock as the port security mode.	

Select **Static Port Lock** and click **Apply**.

Select the edit icon on the port you want to edit.

Port	Enable	Manual Configured Address
 1/1	Disabled	0
 1/2	Disabled	0
 1/3	Disabled	0
 1/4	Disabled	0

Configure the following settings.

Edit Port 1/1 Setting

Static Port Lock
 Disabled ▼

Cancel Apply

Enable

Setting	Description	Factory Default
Enabled	Enable Static Port Lock.	Disabled
Disabled	Disable Static Port Lock.	

When finished, click **Apply** to save your changes.

Next, click the **Static Port Lock** tab and then the + icon to perform further settings.

Port Security

General
Static Port Lock

Port Security Mode
Static Port Lock

Total Trust Hosts
0

System Max. Address
1024

+
↻
+

<input type="checkbox"/>	Port	VLAN	MAC Address	Type

Configure the following settings.

Create Entry

Port ▼

VLAN ID *

MAC Address * i

Cancel Create

Port

Setting	Description	Factory Default
Select the port from the drop-down list	Specify the port(s) that will be used with Static Port Lock.	None

VLAN ID

Setting	Description	Factory Default
Input the VLAN ID	Specify the VLAN ID that will use Static Port Lock.	None

MAC Address

Setting	Description	Factory Default
Input the MAC address that will be used	Specify the MAC Address of the device that will be used as the reliable source for network access.	None

When finished, click **Create**.

You can view the Static Port Lock setting status from the following figure.

Max 1024

Traffic Storm Control

A traffic storm can happen when packets flood the network; this causes excessive traffic and slows down the network performance. To counter this, Traffic Storm Control provides an efficient design to prevent the network from flooding caused by a broadcast, multicast, or unicast traffic storm on a physical network layer. The feature can handle packets from both ingress and egress data.

First click **Traffic Storm Control** on the menu, and then click the edit icon on the specific port you want to configure.

Configure the following settings.

Edit Port 1/1 Setting

Broadcast
 Enabled ▼

Multicast
 Disabled ▼

DLF
 Disabled ▼

Threshold *
 12700 i

1 - 1488100 fps

Copy Config to Ports ▼ i

Cancel Apply

There are three methods that can be used for traffic storm control: Broadcast, Multicast, and Destination Lookup Failure (DLF).

Broadcast

Setting	Description	Factory Default
Enabled	Enable Broadcast when a traffic storm occurs.	Disabled
Disabled	Disable Broadcast when a traffic storm occurs.	

Multicast

Setting	Description	Factory Default
Enabled	Enable multicast when a traffic storm occurs.	Disabled
Disabled	Disable multicast when a traffic storm occurs.	

DLF

Setting	Description	Factory Default
Enabled	Enable DLF when a traffic storm occurs.	Disabled
Disabled	Disable DLF when a traffic storm occurs.	

Threshold (fps)

Setting	Description	Factory Default
1 to 1488100	Define the threshold for a traffic storm.	12700

Copy Config to Ports

Setting	Description	Factory Default
Select the port(s) from the drop-down list	Select the port(s) you want to have the same configurations for.	None

When finished, click **Apply** to save your changes.

Authentication

This section describes how to configure system authentication including RADIUS and TACACS+. Moxa switches have three different user login authentications: TACACS+ (Terminal Access Controller Access-Control System Plus), RADIUS (Remote Authentication Dial In User Service), and Local. The TACACS+ and RADIUS mechanisms are centralized "AAA" (Authentication, Authorization, and Accounting) systems for connecting to network services. The fundamental purpose of both TACACS+ and RADIUS is to provide an efficient and secure mechanism for user account management.

There are five combinations available for users to choose from:

1. **TACACS+, Local:** Check the TACACS+ database first. If checking the TACACS+ database fails, then check the Local database.
2. **RADIUS, Local:** Check the RADIUS database first. If checking the RADIUS database fails, then check the Local database.
3. **TACACS+:** Only check TACACS+ database.
4. **RADIUS:** Only check the RADIUS database.
5. **Local:** Only check the Local database.

This section includes the configurations for **Login Authentication**, **RADIUS**, and **TACACS+**.

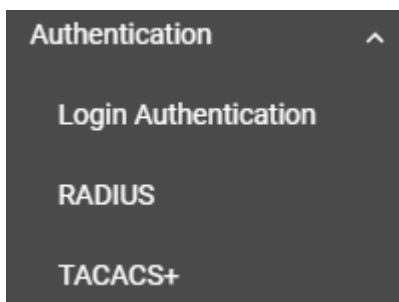

Login Authentication

This section allows users to select the login authentication protocol.

Select **Login Authentication**.

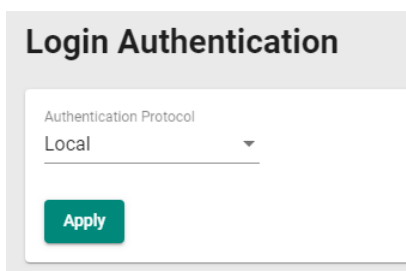

Configure the following settings.

Authentication Protocol

Setting	Description	Factory Default
Local	Select Local as the authentication protocol.	Local
RADIUS	Select RADIUS as the authentication protocol.	
TACACS+	Select TACACS+ as the authentication protocol.	
RADIUS, Local	Select RADIUS and Local as the authentication protocol.	
TACACS+, Local	Select TACACS+ and Local as the authentication protocol.	

When finished, click **Apply** to save your changes.

RADIUS

Click **RADIUS** on the menu and configure the following settings.

RADIUS Server

Server Address 1 *
0.0.0.0

UDP Port *
1812

Share Key i

Authentication Type *
CHAP

Timeout *
5
5 - 180 sec

Retry *
1
0 - 5

Server Address 2 *
0.0.0.0

UDP Port *
1812

Share Key i

Authentication Type *
CHAP

Timeout *
5
5 - 180 sec

Retry *
1
0 - 5

Apply

Server Address 1

Setting	Description	Factory Default
Input the server address	Specify the 1 st server address as the authentication database.	0.0.0.0

UDP Port

Setting	Description	Factory Default
Input the port number	Specify the UDP port.	1812

Share Key

Setting	Description	Factory Default
Input the key	Input the share key for 1 st server authentication verification.	None

Authentication Type

Setting	Description	Factory Default
PAP	PAP is the authentication type.	CHAP
CHAP	CHAP is the authentication type.	
MS-CHAPv1	MS-CHAPv1 is the authentication type.	

Timeout (sec.)

Setting	Description	Factory Default
5 to 180	When waiting for a response from the server, set the amount of time before timeout.	5

Retry (sec.)

Setting	Description	Factory Default
0 to 5	Define the retry interval when trying to reconnect to a server.	1

Server Address 2

Setting	Description	Factory Default
Input the server address	Specify the 2 nd server address as the authentication database.	0.0.0.0

UDP Port

Setting	Description	Factory Default
Input the port number	Specify the UDP port.	1812

Share Key

Setting	Description	Factory Default
Input the key	Specify the share key for 2 nd server authentication verification.	None

Authentication Type

Setting	Description	Factory Default
PAP	PAP is the authentication type.	CHAP
CHAP	CHAP is the authentication type.	
MS-CHAPv1	MS-CHAPv1 is the authentication type.	

Timeout (sec.)

Setting	Description	Factory Default
5 to 180	When waiting for a response from the server, set the amount of time before the device is timed out.	5

Retry (sec.)

Setting	Description	Factory Default
0 to 5	Set the retry interval when trying to reconnect to a server.	1

When finished, click **Apply** to save your changes.

NOTE The RADIUS service will be operated via the 1st server; if it fails, it will run on the 2nd server.

TACACS+

Click **TACACS+** on the menu and then configure the following settings.

TACACS+ Server

Server Address 1 * 0.0.0.0	TCP Port * 49
Share Key i	
Auth Type * CHAP ▼	
Time out * 5	
Retry * 1	
Server Address 2 * 0.0.0.0	TCP Port * 49
Share Key i	
Auth Type * CHAP ▼	
Time out * 5	
Retry * 1	

Apply

Server Address 1

Setting	Description	Factory Default
Input the server address	Specify the 1 st server address as the authentication database.	0.0.0.0

TCP Port

Setting	Description	Factory Default
Input the port number	Specify the UDP port.	49

Share Key

Setting	Description	Factory Default
Input the key	Specify the share key for 1 st server authentication verification.	None

Authentication Type

Setting	Description	Factory Default
ASCII	ASCII is the authentication type.	CHAP
PAP	PAP is the authentication type.	
CHAP	CHAP is the authentication type.	

Timeout (sec.)

Setting	Description	Factory Default
Input the value	When waiting for a response from the server, set the amount of time before the device is timed out.	5

Retry

Setting	Description	Factory Default
Input the value	Set the retry interval when trying to reconnect to a server.	1

Server Address 2

Setting	Description	Factory Default
Input the server address	Specify the 2 nd server address as the authentication database.	0.0.0.0

TCP Port

Setting	Description	Factory Default
Input the port number	Specify the UDP port.	49

Share Key

Setting	Description	Factory Default
Input the key	Specify the share key for 2 nd server authentication verification.	None

Authentication Type

Setting	Description	Factory Default
ASCII	ASCII is the authentication type.	CHAP
PAP	PAP is the authentication type.	
CHAP	CHAP is the authentication type.	

Timeout (sec.)

Setting	Description	Factory Default
Input the value	When waiting for a response from the server, set the amount of time before the device is timed out.	5

Retry

Setting	Description	Factory Default
Input the value	Set the retry interval when trying to reconnect to a server.	1

When finished, click **Apply** to save your changes.

NOTE The TACACS+ service will be operated via the 1st server; if it fails, it will run on the 2nd server.

Diagnostics

This section describes the diagnostics functions of Moxa's switch. Click **Diagnostics** on the function menu.

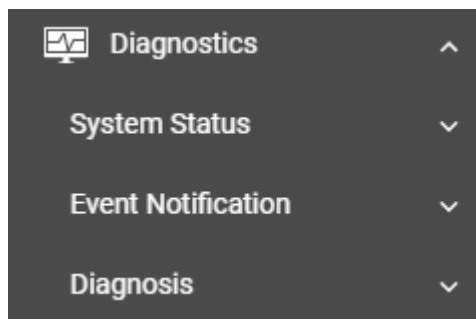

System Status

This section allows users to view the current system status including **Utilization**, **Statistics**, and **Module Information**.

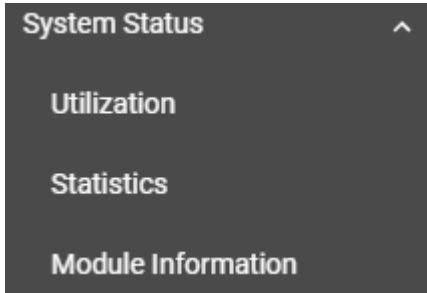

Utilization

Click **Utilization** on the function menu to view the current utilization status including CPU utilization, memory history, power consumption, and power history. All of the information is displayed via graphics, making it easier for users to view the system status. In addition, a refresh icon is available on the upper right corner of each figure, which allows users to view the latest status for each function.

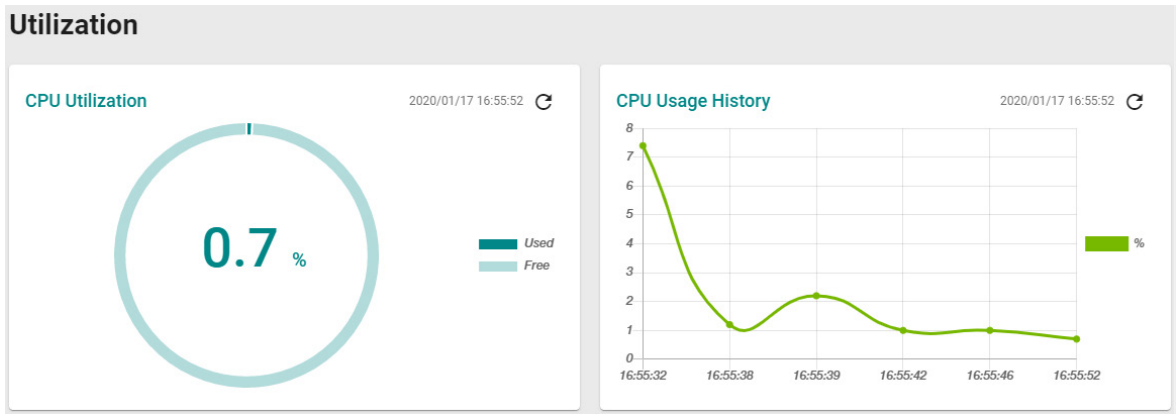

CPU Utilization

Setting	Description	Factory Default
Read-only	Displays the current utilization of the CPU.	None

CPU Usage History

Setting	Description	Factory Default
Read-only	Displays the CPU usage history trend in a chart.	None

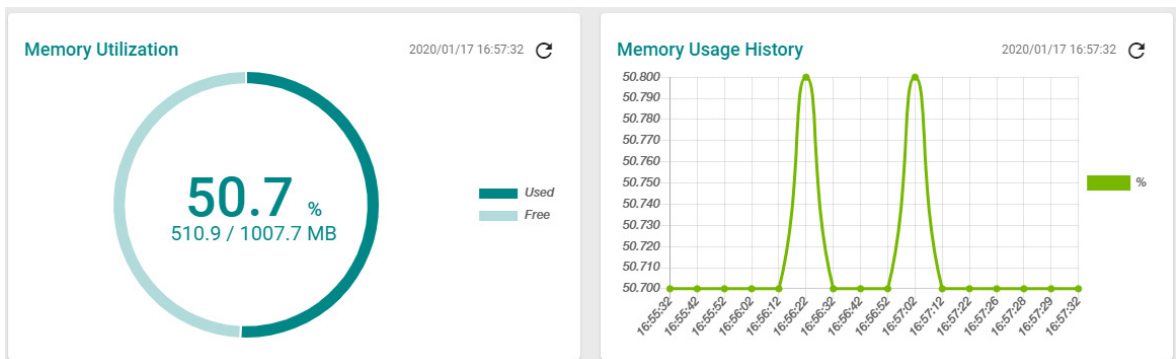

Memory Utilization

Setting	Description	Factory Default
Read-only	Displays the memory status.	None

Memory Usage History

Setting	Description	Factory Default
Read-only	Displays the history of the memory usage.	None

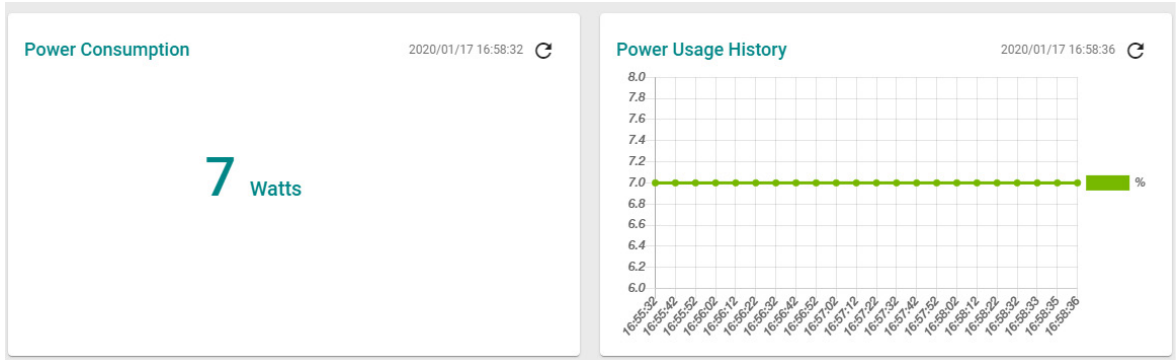

Power Consumption (watt)

Setting	Description	Factory Default
Read-only	Displays the power consumption status.	None

Power Usage History

Setting	Description	Factory Default
Read-only	Displays the history of the power usage.	None

Statistics



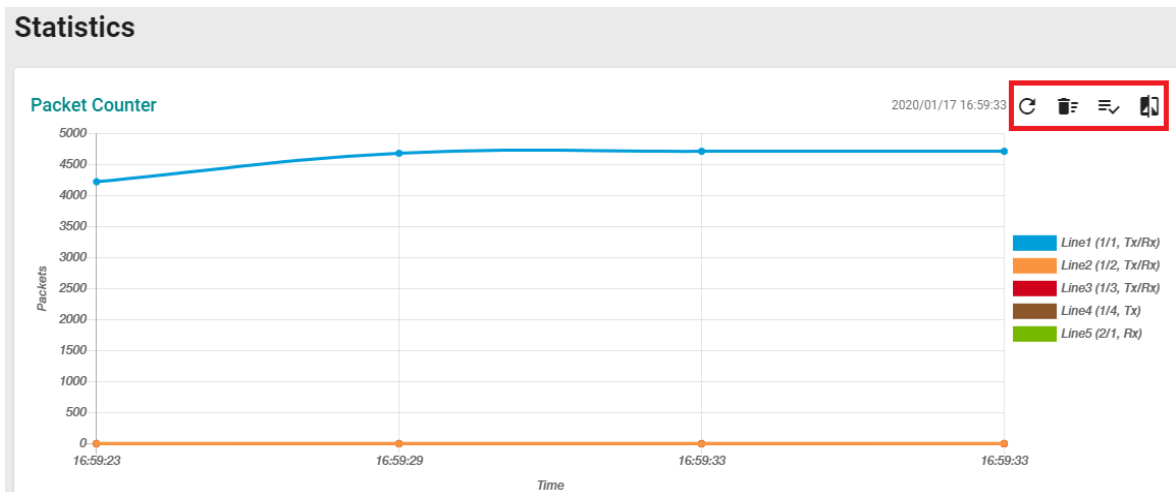

Click **Statistics** on the function menu. The first figure shows the packet counter status.



The status of the different ports will be shown in different colors. A maximum of five ports will have their information displayed.

- Line1 (1/1, Tx/Rx)
- Line2 (1/2, Tx/Rx)
- Line3 (1/3, Tx/Rx)
- Line4 (1/4, Tx)
- Line5 (2/1, Rx)

There are four icons on the right upper corner of the page. The table below provides a description for each one.

Item	Name	Description
	Refresh	All statistical data will be refreshed.
	Reset Statistics Graph	The packet counter will be cleared and the graphs will be reset.
	Display Setting	All selected setting items will be shown here.
	Data Comparison	Select the data you want to compare.

Refreshing the Statistics

Click the **Refresh** button and all statistical data will be refreshed immediately.

Resetting Statistics Graph

Click the **Reset** button and select **Clear** to clear the packet counter and reset the graph.

Reset Statistics Graph

Are you sure to clear all graph data?



Display Setting

Click the **Display Setting** icon and all settings will be displayed. You can select the display mode from the drop-down list.

Display Setting

Display Mode

Packet Counter

Line 1 Monitoring Port *

1/1

Line 1 Sniffer *

Tx/Rx

Line 2 Monitoring Port *

1/2

Line 2 Sniffer *

Tx/Rx

Line 3 Monitoring Port *

1/3

Line 3 Sniffer *

Tx/Rx

Line 4 Monitoring Port *

1/4

Line 4 Sniffer *

Tx

Line 5 Monitoring Port *

2/1

Line 5 Sniffer *

Rx

Cancel

Apply

The Monitoring Port is the port you want to view or monitor. The sniffer port is the port that you can choose to view its receiving or transmission status or both.

Display Mode

Setting	Description	Factory Default
Packet Counter	The packet statistics will be displayed.	Packet Counter
Bandwidth Utilization	The bandwidth statistics will be displayed.	

Click **Apply** to complete.

Comparing Data

Click the **Data Comparison** icon and then select the items from the relevant fields.

Data Comparison

Benchmark Line * Benchmark Line - Ti...

Comparison Line * Comparison Line - Ti...

Close

Click **Close** to complete.

The data comparison figure will be shown. Click Close to finish.

Data Comparison

Benchmark Line *	Benchmark Line - Time *
1/1, Tx/Rx	16:18:58
Comparison Line *	Comparison Line - Time *
1/2, Tx/Rx	16:19:08

Tx Total Packets	-5082	↓	↓
Rx Total Packets	-4470	↓	↓
Tx Total Octets	-7015128	↓	↓
Rx Total Octets	-486762	↓	↓
Collision Packets	0	⊕	↓
CRC Align Error Packets	0	⊕	↓
Drop Packets	0	⊕	↓

Close

The detailed packet transmission activity for each port can be seen in the table below.

🔍 Search

Port	Tx Total Octets	Tx Total Packets	Tx Unicast Packets	Tx Multicast Packets	Tx Broadcast Packets	Rx Total Octets	Rx Total Packets	Rx Unicast Packets	Rx Multicast Packets
1/1	10877827	7891	7826	64	1	649940	5501	3706	1482
1/2	0	0	0	0	0	0	0	0	0
1/3	0	0	0	0	0	0	0	0	0
1/4	0	0	0	0	0	0	0	0	0

Collision Packets	Late Collision Packets	Excessive Collision Packets	CRC Align Error Packets	Drop Packets	Undersize	Oversize Packets	Fragment Packets	Jabber Packets
0	0	0	0	0	0	0	0	0
0	0	0	0	0	0	0	0	0
0	0	0	0	0	0	0	0	0
0	0	0	0	0	0	0	0	0

Port: port number

Tx Total Octets: Number of octets transmitted including bad packets and FCS octets. Framing bits are not included.

Tx Total Packets: Number of packets transmitted.

Tx Unicast Packets: Number of Unicast packets transmitted.

Tx Broadcast Packets: Number of good Broadcast packets transmitted. Multicast packets are not included.

Rx Total Octets: Number of octets received, including bad packets and FCS octets. Framing bits are not included.

Rx Unicast Packets: Number of Unicast packets received.

Rx Multicast Packets: Number of Multicast packets received.

Rx Broadcast Packets: Number of good Broadcast packets received. Multicast packets are not included.

Rx Pause Packets: Number of pause packets received.

Collision Packets: Number of collisions received. If Jumbo Frames are enabled, the threshold of Jabber Frames is raised to the maximum size of Jumbo Frames.

Late Collision Packets: Number of late collision packets.

Excessive Collision Packets: Number of excessive collision packets.

CRC Align Error Packets: Number of CRC and Align errors that have occurred.

Drop Packets: Number of packets that were dropped.

Undersize: Number of undersized packets (less than 64 octets) received.

Oversize Packets: Number of oversized packets (over 1518 octets) received.

Fragment Packets: Number of fragments (packets with less than 64 octets, excluding framing bits, but including FCS octets) received.

Jabber Packets: Number of received packets that were longer than 1632 octets. This number excludes frame bits, but includes FCS octets that had either a bad FCS (Frame Check Sequence) with an integral number of octets (FCS Error) or a bad FCS with a non-integral octet (Alignment Error) number.

Module Information

Click **Module Information** on the function menu to view the current module information of the switch.

Module Information				
Slot	Module Name	Serial Number	Product Version	Status ↑
PWR2	PWR_LV_P48	TAIBD1011095	V2.0.0	No external power supply for PoE.
M1	MDS-G4028	MOXA00000000	V1.0.0	Normal operation.
M3	LM-7000H-4GSFP		V2.0.0	Normal operation.

For example, in the figure above, the MDS-G4028 switch is installed in Slot M1 and there is an LM-7000H-4GSFP module installed in Slot M3. In addition, a power module has been installed in Slot PWR2.



ATTENTION

When a different type of module has been inserted into the switch, we suggest you re-configure the settings, or use reset to default settings. When the same module is inserted into the slot, users do not need to re-configure the settings or use reset to default settings.

Event Notification

This section includes the information regarding **Event Notification**, **Relay Alarm Cut-off**, **Email Notification**, and **Syslog**.

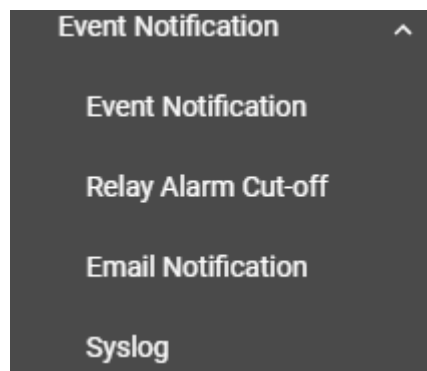

Event Notification

There are two functions within Event Notification: System and Function, and Port.

In the **Event Notification** menu, click the **System and Function** tab, and then click the edit icon on the specific event you want to configure. For example, select the edit icon for warm start when the switch reboots.

Event Notification

System and Function

Port

	Group	Event Name	Enabled	Severity	Registered Action
	General	Warm start	Enabled	Notice	Trap, Email
	General	Password changed	Enabled	Notice	Trap, Email
	General	Login success	Enabled	Notice	Trap, Email
	General	Configuration changed	Enabled	Notice	Trap, Email
	General	Configuration imported	Enabled	Notice	Trap, Email

Configure the following settings.

Edit Event Notification

Event Name
Warm start

Enabled
Enabled ▼

Registered Action
Trap, Email ▼

Cancel
Apply

Enable

Setting	Description	Factory Default
Enabled	Enable Event Notification for this event.	Enabled
Disabled	Disable Event Notification for this event.	

Registered Action

Setting	Description	Factory Default
Trap	Send SNMP Trap for event notifications.	Trap/Email
Email	Send an email for event notifications.	
MGMT Relay	Trigger MGMT Relay for event notifications.	
PWR1 Relay	Trigger PWR1 Relay for event notifications.	
PWR2 Relay	Trigger PWR2 Relay for event notifications.	

When finished, click **Apply** to save your changes.

In addition, use the same method to edit other events, such as login lockout, warm start, password changed, etc.

Next, in the **Event Notification** menu, click the **Port** tab, and then click the edit icon on the specific port status on **Event Name**. For example, select the edit icon for event notifications when the port status is on.

Event Notification

System and Function
Port

	Event Name	Enable	Severity	Registered Action
	Port On	Enabled	Notice	Trap, Email
	Port Off	Enabled	Notice	Trap, Email
	Port shutdown by Port Security	Enabled	Warning	Trap, Email
	Port shutdown by Rate Limit	Enabled	Warning	Trap, Email
	Port recovery by Rate Limit	Enabled	Warning	Trap, Email

Configure the following settings.

Edit Event Notification

Event Name
Port On
.....

Enabled
Enabled ▼

Registered Action
Trap, Email ▼

Registered Port
All Ports ▼

Cancel

Apply

Enable

Setting	Description	Factory Default
Enabled	Enable Event Notification for this event.	Enabled
Disabled	Disable Event Notification for this event.	

Registered Action

Setting	Description	Factory Default
Trap	Send SNMP Trap for event notifications.	Trap/Email
Email	Send an email for event notifications.	
MGMT Relay	Trigger MGMT Relay for event notifications.	
PWR1 Relay	Trigger PWR1 Relay for event notifications.	
PWR2 Relay	Trigger PWR2 Relay for event notifications.	

Registered Port

Setting	Description	Factory Default
Select port(s) from the drop-down list	Specify the port(s) that use the registered action.	All Ports

When finished, click **Apply** to save your changes.

In addition, use the same method to edit other events such as, port status is off, port shutdown by port security, and port recovery by rate limit, etc.

Check the following table for the severity degree of each event.

System & Function	
Event Name	Severity
Cold start	Critical
Warm start	Notice
Configuration changed	Notice
Login success	Notice
Login fail	Warning
Login lockout	Warning
Account setting changed	Notice
Configuration imported	Notice
SSL certification changed	Notice
Log capacity threshold	Warning
Password changed	Notice
PWR Off->On	Notice
PWR On->Off	Notice
DI On	Notice
DI Off	Notice
Topology changed	Warning
Coupling changed	Warning
Master changed	Warning
Master mismatch	Warning
RSTP topology changed	Warning
RSTP root changed	Warning
RSTP migration	Warning
RSTP invalid BPDU	Warning
RSTP new port role	Warning
Redundant port health check fail	Error
Dual homing path changed	Warning
Dot1X auth fail	Warning
LLDP table changed	Information
RMON raising alarm	Warning
RMON failing alarm	Warning
PD power On	Notice
PD power Off	Notice
Low input voltage	Warning
PD over current	Error
PD no response	Error
Over power budget limit	Warning
Power detection failure	Warning

Port	
Event Name	Severity
Port On	Notice
Port Off	Notice
Port shutdown by Port Security	Warning
Port shutdown by Rate Limit	Warning
Port recovery by Rate Limit	Warning

Relay Output Overview

A relay is an electrically operated switch that often uses an electromagnet to mechanically operate a switch. Relays are used to control a circuit by a separate low-power signal, or where several circuits must be controlled by one signal. This is typically safe when the problem or malfunction occurs in a remote device.

Moxa's switches offer three sets of relay outputs, one on the mainboard and two on the power modules, providing the secured protection of the remote switch and secure data communication. In addition, email notifications can also be sent to inform system administrators to perform further checks and maintenance.

Relay Output Settings and Status

To select Relay Output as the event notifications, click **Relay Output** on the function menu.

Relay Alarm Cut-off

MGMT Relay

PWR1 Relay

PWR2 Relay

Apply

Relay Output

Setting	Description	Factory Default
MGMT Relay	Trigger MGMT Relay for event notifications.	None
PWR1 Relay	Trigger PWR1 Relay for event notifications.	
PWR2 Relay	Trigger PWR2 Relay for event notifications.	

When finished, click **Apply** to save your changes.

Email Notification

Select **Email Notification** on the function menu and configure the following settings.

Email Notification

Mail Server *
 7 / 60

TCP Port
 1 - 65535

Username 0 / 60 Password 0 / 60

TLS Enable
 ▼

Sender Address
 19 / 60

1st Recipient Email Add... 0 / 60 2nd Recipient Email Ad... 0 / 60 3rd Recipient Email Add... 0 / 60

4th Recipient Email Add... 0 / 60 5th Recipient Email Add... 0 / 60

Mail Server

Setting	Description	Factory Default
IP address or URL	The IP Address or URL of the email server.	0.0.0.0

TCP Port

Setting	Description	Factory Default
1 to 65535	The TCP port number of your email server.	25

User Name

Setting	Description	Factory Default
Max. of 60 characters	Your email account name.	None

Password

Setting	Description	Factory Default
Max. of 60 characters	Your email account password.	None

TLS Enable

Setting	Description	Factory Default
Enabled	Enable TLS (Transport Layer Security).	Disabled
Disabled	Disable TLS (Transport Layer Security).	

Sender Address

Setting	Description	Factory Default
Max. 60 characters	The sender's email address.	admin@localhost

1st to 5th Email Addresses

Setting	Description	Factory Default
Max. of 60 characters	You can set up to five email addresses to receive alert emails from the Moxa switch.	None

When finished, click **Apply** to save your changes.

Syslog Settings

Click **Syslog** on the function menu and configure the following settings.

Syslog

Syslog

Syslog Server 1

Address 1 UDP Port

1 - 65535

Syslog Server 2

Address 2 UDP Port

1 - 65535

Syslog Server 3

Address 3 UDP Port

1 - 65535

Logging Enable

Setting	Description	Factory Default
Enabled	Enable logging.	Disabled
Disabled	Disable logging.	

Syslog Server 1

Setting	Description	Factory Default
Enabled	Enable the 1 st log server.	Disabled
Disabled	Disable the 1 st log server.	

Address 1

Setting	Description	Factory Default
IP Address	Input the IP address of the Syslog 1 st server that is used by your network.	None

UDP Port

Setting	Description	Factory Default
1 to 65535	Input the UDP port number.	514

Syslog Server 2

Setting	Description	Factory Default
Enabled	Enable the 2 nd syslog server.	Disabled
Disabled	Disable the 2 nd syslog server.	

Address 2

Setting	Description	Factory Default
IP Address	Input the IP address of Syslog 2 nd server that is used by your network.	None

UDP Port

Setting	Description	Factory Default
1 to 65535	Input the UDP port number.	514

Syslog Server 3

Setting	Description	Factory Default
Enabled	Enable the 3 rd syslog server.	Disabled
Disabled	Disable the 3 rd syslog server.	

Address 3

Setting	Description	Factory Default
IP Address	Input the IP address of the Syslog 3 rd server that is used by your network.	None

UDP Port

Setting	Description	Factory Default
1 to 65535	Input the UDP port number.	514

When finished, click **Apply** to save your changes.

NOTE If the syslog server cannot receive the previous logs, it is possible that the receiving port of the syslog server is not ready. We suggest you enable the Linkup Delay function to delay the log delivery time.

Diagnosis

This section explains the configurations for system diagnoses such as **LLDP**, **Port Mirror**, **Ping**, **ARP Table**, and **Event Log**.

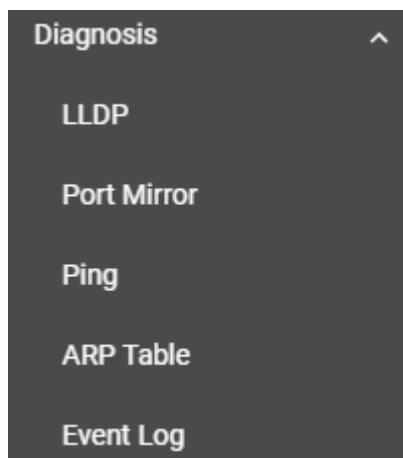

LLDP Overview

LLDP is an OSI Layer 2 protocol defined by IEEE 802.11AB. LLDP standardizes the self-identification advertisement method, and allows each networking device, such as a Moxa managed switch, to periodically send its system and configuration information to its neighbors. Because of this, all LLDP devices are kept informed of each other’s status and configurations. With SNMP, this information can be transferred to Moxa’s MXview for auto-topology and network visualization.

From the switch’s web interface, you can enable or disable LLDP, and set the LLDP transmit interval. In addition, you can view each switch’s neighbor-list, which is reported by its network neighbors. Most importantly, enabling the LLDP function allows Moxa’s MXview to automatically display the network’s topology and system setup details, such as VLAN and Trunking for the entire network.

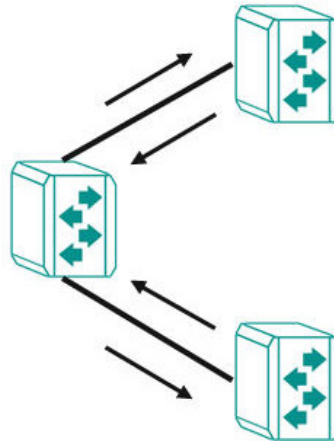

LLDP Settings and Status

Click **LLDP** on the menu and then select the **Setting** tab to configure the following settings.

LLDP

Setting
Status

Enable
Enabled ▼

LLDP Version
2005 ▼

Transmit Interval	Notification Interval	Tx Delay
30	5	2
sec	sec	sec

Reinitialization Delay	Holdtime Multiplier
2	4
sec	x

Chassis Id Subtype
MAC-Addr ▼

Apply

Enable

Setting	Description	Factory Default
Enabled	Enable LLDP.	Disabled
Disabled	Disable LLDP.	

LLDP Version

Setting	Description	Factory Default
Show the LLDP version	Show the LLDP version automatically.	2005

Transmit Interval (sec.)

Setting	Description	Factory Default
5 to 32768	Set the transmit interval of LLDP messages	30

Notification Interval (sec.)

Setting	Description	Factory Default
5 to 3600	Specify the notification interval.	5

Tx Delay (sec.)

Setting	Description	Factory Default
1 to 8192	Specify the Tx delay interval.	2

Reinitialization Delay (sec.)

Setting	Description	Factory Default
1 to 10	Specify the LLDP reinitialization delay interval.	2

Holdtime Multiplier





Setting	Description	Factory Default
2 to 10	Specify the holdtime multiplier value.	4

Chassis ID Subtype

Setting	Description	Factory Default
Chassis-Component	Select Chassis-Component as Chassis ID subtype.	Mac-Addr
If-Alias	Select If-Alias as Chassis ID subtype.	
Port-Component	Select Port-Component as Chassis ID subtype.	
MAC-Addr	Select MAC-Address as Chassis ID subtype.	
Network Address	Select Network Address as Chassis ID subtype.	
If-Name	Select If-Name as Chassis ID subtype.	
Local	Select Local as Chassis ID subtype.	

When finished, click **Apply** to save your changes.

Each port for the LLDP settings can also be configured. Select the edit icon for the port you want to configure.

Port	Port Status
 1/1	Tx and Rx
 1/2	Tx and Rx
 1/3	Tx and Rx
 1/4	Tx and Rx

Configure the following settings.

Edit Port 1/1 Setting

Port Status
Tx and Rx

Subtype
If-Alias

TLV
Basic

Transmit TLVs

Port Description

System Name

System Description

System Capability

Copy Config to Ports i

Cancel

Apply

Port Status

Setting	Description	Factory Default
Tx Only	Set Tx as the port status.	Tx and Rx
Rx Only	Set Rx as the port status.	
Tx and Rx	Set both Tx and Rx as the port status.	

Subtype

Setting	Description	Factory Default
If-Alias	Select If-Alias as the subtype.	If-Alias
Port-Component	Select Port-Component as the subtype.	
MAC-Addr	Select MAC-Address as the subtype.	
If-Name	Select If-Name as the subtype.	
Local	Select Local as the subtype.	

TLV

Setting	Description	Factory Default
Basic	Set TLV as Basic.	Basic
802.1	Set TLV as 802.1.	
802.3	Set TLV as 802.3.	

Transmit TLVs

Setting	Description	Factory Default
Port Description	Add a port description for the TLV.	Port Description System Name
System Name	Add a system name for the TLV.	
System Description	Add a system description for the TLV.	
System Capability	Add a system capability for the TLV.	

Copy Config to Port

Setting	Description	Factory Default
Select the port from the list	Copy the same configurations to other port(s).	None

When finished, click **Apply** to save your changes.

To view the LLDP status, click the **Status** tab on the LLDP page, and the status of all LLDP will be shown on the page.

LLDP

Setting
Status

Local Information

Enable
Enabled

LLDP Version
v1(2005)

Chassis Id Subtype
MAC-Addr

Chassis ID
00:01:02:03:04:05

Local Timer

Transmit Interval
30 (sec)

Notification Interval
5 (sec)

Tx Delay
2 (sec)

Reinitialization Delay
2 (sec)

Holdtime Multiplier
4 (x)

Remote Table Statistics

Last Change Time (ms)
1300

Inserts
1

Drops
0

Delete
0

Ageouts
0

Refer to the following table for the detailed description of each item.

Local Information	
Enable	Show if LLDP has been enabled or disabled.
LLDP Version	Show the LLDP version.
Chassis ID Subtype	Show the chassis ID subtype.
Chassis ID	Show the chassis ID.
Local Timer	
Transmit Interval (sec.)	The interval between regular LLDP packet transmissions.
Notification Interval (sec.)	The interval that notifications will be sent.
Tx Delay (sec.)	The delay period between successive LLDP frame transmissions initiated by changes.
Reinitialization Delay (sec.)	The interval an LLDP port waits before re-initializing an LLDP packet transmission.
Holdtime Multiplier	The amount of time that the receiving device holds an LLDP packet before discarding it.
Remote Table Statistics	
Last Change Time (ms.)	The last time the remote table changed.
Inserts	How many inserts have occurred.
Drop	How many drops have occurred.
Delete	How many deletes have occurred.
Ageouts	How many ageouts have occurred.

To view the LLDP status for a specific port, click the detailed information icon on the port. All information will be shown on the right side of the page.

Port	Tx Status	Rx Status	Nbr. Port ID	Nbr. Chassis ID	Detail Information
1/1	Enabled	Enabled	28:d2:44:5e:8b:40	28:d2:44:5e:8b:40	<p>Port Local Interface</p> <p>Port ID SubType Chassis-Component</p> <p>Port ID Eth1/1</p> <p>Port Description Ethernet Interface Port 01</p> <hr/> <p>Extended 802.1 TLV</p> <p>Port VLAN ID 1</p> <p>VLAN ID / Name 1 / factory</p> <hr/> <p>Extended 802.3 TLV</p> <p>Aggregated and Status Disabled</p> <p>Aggregated Port Id 0</p> <p>Maximum Frame Size 1522</p>
1/2	Enabled	Enabled			
1/3	Enabled	Enabled			
1/4	Enabled	Enabled			
2/1	Enabled	Enabled			
2/2	Enabled	Enabled			
2/3	Enabled	Enabled			
2/4	Enabled	Enabled			
3/1	Enabled	Enabled			
3/2	Enabled	Enabled			
3/3	Enabled	Enabled			
3/4	Enabled	Enabled			
4/1	Enabled	Enabled			

Port Mirroring

Port Mirroring Overview

The **Port Mirroring** function can be used to monitor data being transmitted through a specific port. This is done by setting up another port (the mirror port) to receive the same data being transmitted from, or both to and from, the port under observation. Using a mirror port allows the network administrator to **sniff** the observed port to keep tabs on network activity.

NOTE The MDS-G4000 Series allows up to five many-to-many port mirroring sessions. Please note the mirrored and mirroring port cannot be duplicated on each session.

How Port Mirror Works

Port Mirroring can configure to copy one or more packets from various ports to a single port, so that users can check if there are problems occurring in these ports. For example, the following figure demonstrates how the packets transmitted in the four mirrored ports (marked in orange) are copied (mirrored) to a single mirroring port (marked in green). These packets will be sent to a monitoring computer and then software is used to check if there is something wrong with these packets. It is a useful function to troubleshoot or debug a network data transmission issue.

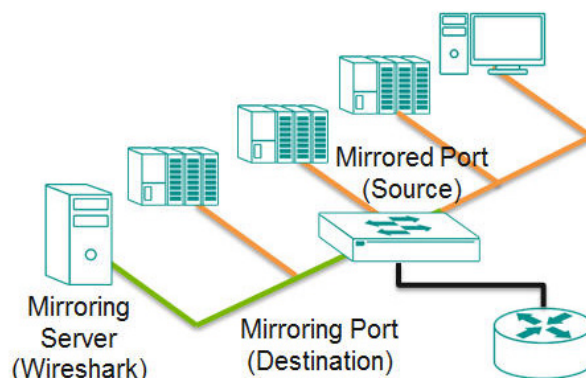

Port Mirror Settings and Status

Click **Port Mirror** on the menu and then configure the settings.

Port Mirror

Port Mirror
Enabled ▼

Apply

Enable

Setting	Description	Factory Default
Enabled	Enable Port Mirror.	Enabled
Disabled	Disable Port Mirror.	

When finished, click **Apply** to save your changes.

To configure the specific port, click the edit icon next to the port.

	Session ID	Enable	Tx Source Port
	1	Disabled	
	2	Disabled	
	3	Disabled	
	4	Disabled	
	5	Disabled	

NOTE A maximum of five port mirroring many-to-many port combinations can be enabled for each session.

Configure the following settings.

Edit Session 1 Setting

Enable ^{*}
Disabled ▼

Tx Source Port ▼

Rx Source Port ▼

Destination Port * ▼

Cancel

Apply

Enable

Setting	Description	Factory Default
Enabled	Enable Port Mirror for this session.	Disabled
Disabled	Disable Port Mirror for this session.	

Tx Source Port

Setting	Description	Factory Default
Select the port from the list	Select this option to monitor only those data packets being sent out through the switch's port.	None

Rx Source Port

Setting	Description	Factory Default
Select the port from the list	Select this option to monitor only those data packets coming into the switch's port.	None



Destination Port

Setting	Description	Factory Default
Select the port from the list	Specify this port as the destination port.	None

When finished, click **Apply** to save your changes.

NOTE The RSTP ports and Port Mirror destination port cannot be enabled on the same port.

The Port Mirror status can be seen in the figure below.

Edit	Session ID	Enable	Tx Source Port	Rx Source Port	Destination Port
	1	Enabled	1/1	1/2	1/3
	2	Disabled			

Ping

The **Ping** function uses the ping command to give users a simple but powerful tool for troubleshooting network problems. The function most unique feature of the function is that even though the ping command is entered from the user's PC, the actual ping command originates from the Moxa switch itself. This allows the user to essentially sit on top of the Moxa switch and send ping commands out through its ports.

To use the Ping function, click **Ping** on the menu, and enter the IP address or domain name you want to ping. After clicking **Ping**, the result will be shown.

Ping

ARP Table

To view the ARP Table, select **ARP Table** and the information will be displayed.



Event Log

To edit the event log overseize-action, click **Event Log** on the menu, and then select **Event Log** on the page.

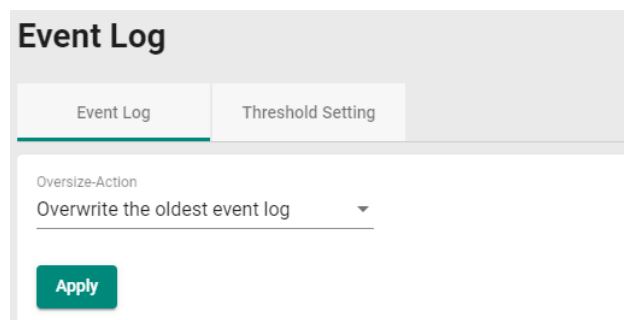



Configure the following settings when the event log file is full.

Oversize-Action

Setting	Description	Factory Default
Overwrite the oldest event log	Overwrite the oldest event log.	Overwrite the oldest event log
Stop recording event log	Disable Port Mirror for this port.	

Click **Apply** to finish.

To view all of the event formation, check the lower part of the event log page.

Index	Bootup Number	Severity	Timestamp	Uptime	Message
1	3	Notice	2016-11-03 17:17:24	0d0h0m50s	[Account:admin] successfully logged in via local.
2	3	Critical	2016-11-03 17:17:09	0d0h0m35s	System has performed a cold start.
3	3	Info	2016-11-03 17:17:00	0d0h0m26s	LLDP remote table changed.
4	3	Notice	2016-11-03 17:17:00	0d0h0m26s	Port 1/3 link up.
5	3	Notice	2016-11-03 17:16:46	0d0h0m11s	The hardware revision of Power Module 2 is not allowed.
6	2	Notice	2016-11-05 13:54:16	1d20h37m43s	[Account:admin] successfully logged in via local.
7	2	Notice	2016-11-05 13:49:37	1d20h33m3s	[Account:admin] successfully logged in via local.
8	2	Info	2016-11-05 13:47:33	1d20h31m0s	LLDP remote table changed.
9	2	Notice	2016-11-05 13:47:33	1d20h30m59s	Port 1/3 link up.
10	2	Notice	2016-11-05 13:47:23	1d20h30m50s	Port 1/1 link down.
11	2	Notice	2016-11-05 13:47:16	1d20h30m42s	Configuration [Mgmt IP] changed by admin.
12	2	Notice	2016-11-03 17:30:01	0d0h13m28s	Configuration [Account] changed by admin.
13	2	Notice	2016-11-03 17:28:55	0d0h12m22s	[Account:admin] successfully logged in via local.
14	2	Notice	2016-11-03 17:19:52	0d0h3m19s	[Account:admin] successfully logged in via local.
15	2	Notice	2016-11-03 17:19:30	0d0h2m57s	Configuration [Web] changed by admin.
16	2	Notice	2016-11-03 17:18:53	0d0h2m19s	Configuration [Web] changed by admin.

Threshold Settings

To configure the event log threshold, click the **Threshold Setting** tab on the Event Log Page. The event log threshold can be set up to send an early warning when the event log entries have reached the percentage of the threshold. The maximum recorded event log entries is 10,000.

Event Log

Event Log

Threshold Setting

Capacity Warning
Disabled i

Warning Threshold *
80 %

50 - 100 %

Apply

Configure the following settings.

Capacity Warning

Setting	Description	Factory Default
Enabled	Enable capacity warning event log.	Disabled
Disabled	Disable capacity warning event log.	

Warning Threshold (%)

Setting	Description	Factory Default
50 to 100	Set the warning threshold as a percentage.	80

Maintenance and Tool

This section explains how to maintain Moxa's switch and the tools that help users operate the switch. Click the icon on the upper right corner of the page.

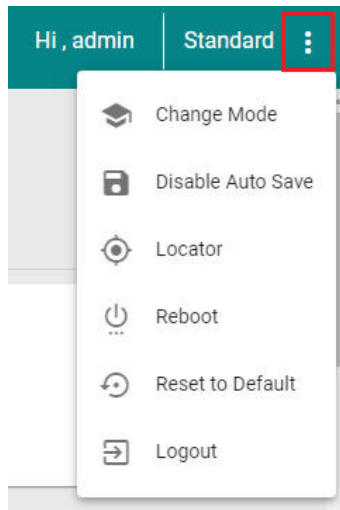

Standard/Advanced Mode

There are two configuration modes available for users: **Standard Mode** and **Advanced Mode**.

1. In **Standard Mode**, some of the features/parameters will be hidden to make it easier to perform configurations (this is the default setting).
2. In **Advanced Mode**, some advanced features/parameters will be available for users to adjust these settings.

To switch to Advanced Mode, click the change mode icon on the upper right corner of the page, and then select **Change Mode**.

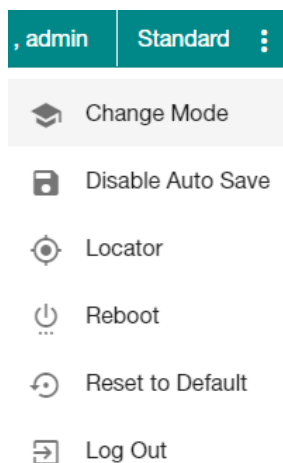

Click **Change** to change to **Advanced Mode**.

Change to Advanced mode

Are you sure you want to change from Standard mode to Advanced mode?

Cancel

Change

Advanced Mode offers more detailed system configurations for specific functions. Use the same process if you want to return to Standard Mode.

Disable Auto Save

Auto Save allows users to save the settings to the start-up configurations; all parameters will be effective when applied immediately, even when the switch has restarted. When users select **Disable Auto Save**, all parameters will be temporarily stored in the running config (memory), and a disk icon will appear on the upper right corner of the page. Users need to save the running-configuration to the startup-configuration when changing any parameters or function after clicking **Apply**.

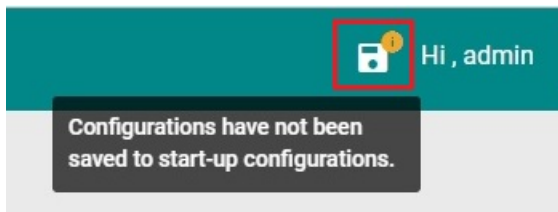

It is highly recommended that you always manually save all configurations by clicking Save Disk icon when **Disable Auto Save** is applied, or all information will have disappeared after the switch has restarted.

When **Disable Auto Save** is applied, only the configurations that are running will be saved; users can unplug the power or perform a warm start to recover the network before manually saving the configurations. When Auto Save is enabled, the start-up configurations will be saved in the switch.

To disable the **Auto Save** function, click **Disable Auto Save** in the menu.

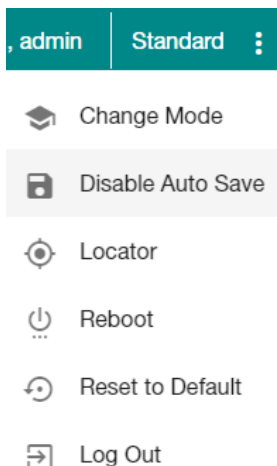

Click **Disable**.

Disable auto save mode

Are you sure you want to disable auto save mode?



Locator

Users can trigger the device locator by clicking this icon. This will cause the LED indicators on the switch to flash for one minute. This helps users easily find the location of the switch in a field site.

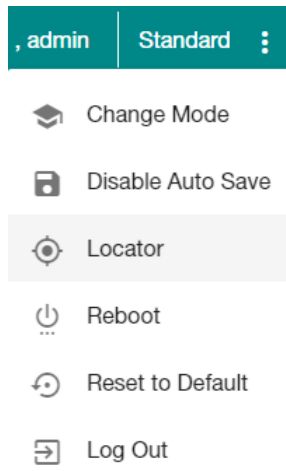

Click **Locate** to finish.

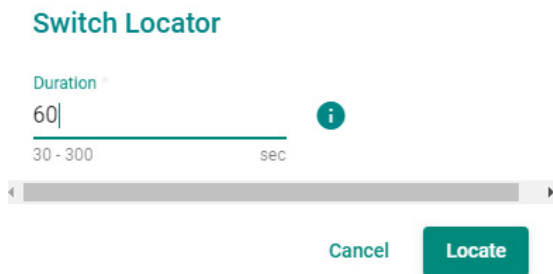

Duration (sec.)

Setting	Description	Factory Default
30 to 300	Specify the length of time the indicators will remain flashing.	60

Click **Locate** to activate the switch locator. The LED indicators are located on the upper left corner of the switch as can be seen in the figure below.

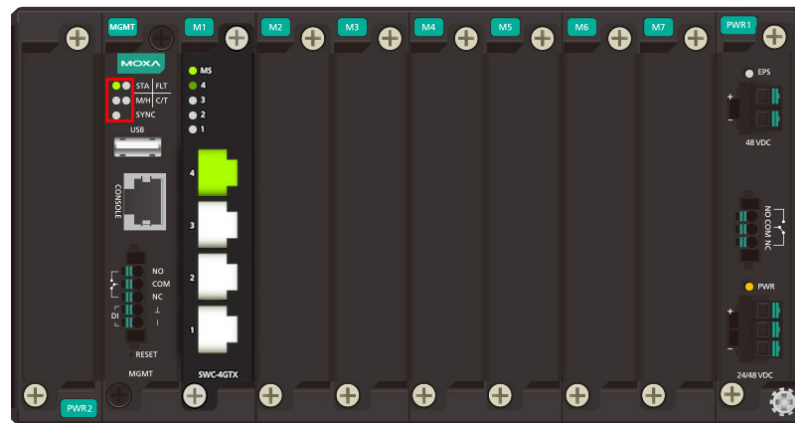

Reboot

To reboot the device, select **Reboot**.

admin Standard

- Change Mode
- Disable Auto Save
- Locator
- Reboot**
- Reset to Default
- Log Out

Click **Restart** to reboot the device.

Restart the device

Are you sure you want to restart the device?

Cancel Restart

Reset to Default

To reset the switch to the default status, select **Reset to Default**.

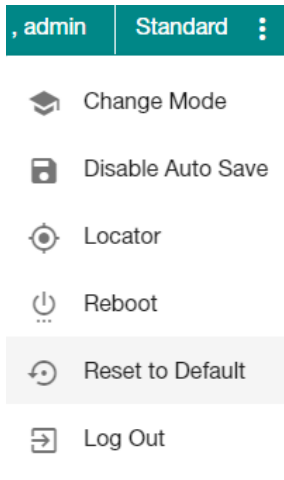

To return the switch to factory default settings, click **Reset**.

Factory default

Are you sure you want to reset the system configurations to factory default?



Log Out of the Switch

To log out of the switch, select **Log Out**.

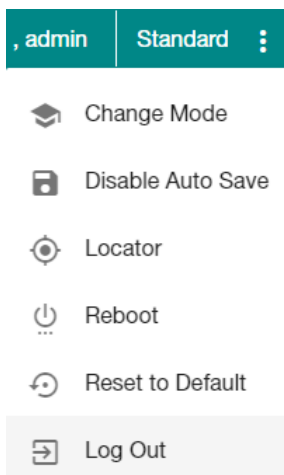

Click **Log Out** to log out of the switch.

Logout

Are you sure you want to logout?



A

Account Privileges List

This appendix describes the read/write access privileges for different accounts on Moxa's Managed Ethernet Series switches.

The following topic is covered in this appendix:

- **Account Privileges List**

Account Privileges List

This appendix lists the privileges for different account roles.

Please note, **R** stands for **Read** and **W** stands for **Write**.

Function	Account Privilege			
	System	Admin	Supervisor	User
Information Setting	R/W	R/W	R	
Firmware Upgrade	Execute	No Access	No Access	
Configuration Backup and Restore	Execute	Execute	No Access	
Event log backup	Execute	Execute	Execute	
User Account	R/W	No Access	No Access	
Password Policy	R/W	No Access	No Access	
IP Configuration	R/W	R/W	R	
DHCP Server	R/W	R/W	R	
Time Zone	R/W	R/W	R	
System Time	R/W	R/W	R	
Port				
Port Setting	R/W	R/W	R	
Linkup Delay	R/W	R/W	R	
Link Aggregation (Port Channel)	R/W	R/W	R	
PoE	R/W	R/W	R	
VLAN				
IEEE 802.1Q	R/W	R/W	R	
GARP	R/W	R/W	R	
MAC				
Static Unicast	R/W	R/W	R	
MAC Address Table	R/W	R/W	R	
QoS				
Classification	R/W	R/W	R	
Ingress Rate Limit	R/W	R/W	R	
Scheduler	R/W	R/W	R	
Egress Shaper	R/W	R/W	R	
Multicast				
IGMP Snooping	R/W	R/W	R	
Static Multicast	R/W	R/W	R	
GMRP	R/W	R/W	R	
Layer 2 Redundancy				
Spanning Tree	R/W	R/W	R	
Turbo Ring v2	R/W	R/W	R	
Turbo Chain	R/W	R/W	R	
Dual Homing	R/W	R/W	R	
Network Management				
SNMP	R/W	No Access	No Access	
SNMP Trap/Inform	R/W	No Access	No Access	
RMON1 (CLI only)	R/W	R/W	R	

System	Admin	Supervisor	User
Security			
Management Interface	R/W	R/W	R
Login Policy	R/W	R	R
Trusted Access	R/W	R	R
SSH & SSL	Execute	Execute	No Access
IEEE802.1X	R/W	R/W	R
Port Security	R/W	R/W	R
Traffic Storm Control	R/W	R/W	R
Authentication			
RADIUS	R/W	No Access	No Access
TACACS+	R/W	No Access	No Access
Login Authentication	R/W	No Access	No Access
Diagnostics			
Event Notification	R/W	R/W	R
Relay Output	R/W	R/W	R
Email Notification	R/W	R	R
Syslog	R/W	R	R
Event Log	R/W	R/W	R
LLDP	R/W	R/W	R
Port Mirror	R/W	R/W	R
Ping	Execute	Execute	Execute
ARP Table	R/W	R/W	R
Utilization	R	R	R
Statistics	R	R	R
Module information	R	R	R
Maintenance and Tool			
Standard/Advance Mode	Execute	Execute	Execute
Disable Auto Save	R/W	R/W	R
Locator	R/W	R/W	Execute
Reboot	Execute	Execute	No Access
Reset to default	R/W	No Access	No Access

B

Event Log Description

This appendix describes all of the information for the event logs. When an event occurs, it will be recorded in the event log files. Users can check the event log name and its event log description.

The following topic is covered in this appendix:

- **Event Log Description**

Event Log Description

Event Log Name	Event Log Description
Login success	[Account:{{user_name}}] successfully logged in via {{interface}}.
Login fail	[Account:{{user_name}}] log in failed via {{interface}}.
Login lockout	[Account:{{user_name}}] locked due to {{failed_times}} failed login attempts.
Account setting changed	Account settings of [Account:{{user_name}}] has been updated. Account settings of [Account:{{user_name}}] has been deleted. Account settings of [Account:{{user_name}}] has been created.
SSL Certification changed	SSL certificate has been changed. SSL certificate has been regenerated.
Password changed	The password of [Account:{{user_name}}] has been changed.
Cold start	The system has performed a cold start.
Warm start	The system has performed a warm start.
Configuration Changed	Configurations {{modules}} have been changed by [Account:{{user_name}}].
Configuration Imported	Configuration import has {{'successful'/'failed'}} by [Account:{{user_name}}].
Log capacity threshold	The threshold of event log entries {{numbers}} has been reached.
PWR On	Power {{index}} has turned on.
PWR Off	Power {{index}} has turned off.
DI On	Digital Input {{index}} has turned on.
DI Off	Digital Input {{index}} has turned off.
Port link up	Port {{number}} link up.
Port link down	Port {{number}} link down.
Port Shutdown by Rate Limit	Port {{number}} has excessive traffic and has shut down.
Port Recovery by Rate Limit	Port {{number}} has been recovered by rate limit.
Port Shutdown by Port Security	Port {{number}} has shut down due to violation of Port Security rule.
Topology Changed (Turbo Ring)	Topology has been changed by Turbo Ring.
Topology Changed (RSTP)	Topology has been changed by RSTP.
Topology Changed (Turbo Chain)	Topology has been changed by Turbo Chain.
Topology Changed (Dual Homing)	Topology has been changed by Dual Homing.
Coupling Changed	Turbo Ring v2 Coupling path status has changed.
Master Changed	Ring {{Index}} master has changed.
Master Mismatch	Ring {{Index}} master setting does not match.
RSTP Topo. Changed	Topology has been changed by RSTP.
RSTP Root Changed	RSTP new root has been elected in topology.
RSTP Migration	Port {{number}} changed to RSTP Port {{number}} changed to STP.
RSTP Invalid BPDU	RSTP port {{number}} received an invalid BPDU (type: {{type}}, value:{{value}}).
RSTP new port role	RSTP port {{number}} role changed from {{role}} to {{role}}.
Redundant port health check fail	Redundant port {{number}} health check fail.
Dual Homing path changed	Dual Homing path has switched.
Dot1x Auth Fail	802.1X authentication failed on port {{number}} with {{mac address}}.
LLDP Table Changed	LLDP remote table changed.
RMON raising alarm	{{user defined}}.
RMON falling alarm	{{user defined}}.
PD power on	Port {{number}} PD power on.
PD power off	Port {{number}} PD power off.
Low input voltage	The input voltage of the power supply has dropped below 46 VDC. Please adjust the voltage to between 46 and 57 VDC to fit the PoE voltage requirements.

Event Log Name	Event Log Description
PD over current	Current of port {{number}} has exceeded the safety limit. Please check the device status.
PD no response	Port {{number}} device is not responding to the PD failure check. Please check the device status.
Over power budget limit	The consumed power {{power_value}} of all the PDs have exceeded the maximum input power {{input_power_value}}.
Power detection failure	1. Port {{number}} device is {{Legacy PD}}. Please {{enable legacy PD detection}}. 2. Port {{number}} device is {{Unknown}}. Please {{select PoE output mode to Force}}.
Relay Override Message	{{MGMT/PWR1/PWR2}} relay alarm is on due to {{Event Name}}.
SSH Key Generate	SSH key has been regenerated.
Configuration Export	Configuration export {{successful /failed}} by [Account:{{user_name}}].
FWR upgrade success	Firmware Successfully Upgraded.
Module init fail	Module {{module_number}} Initialized Failed.
Violation in Port Security	Port {{number}} dropped packets due to violation of Port Security rule.
Relay Cut Off	{{relay_name}} relay alarm has been cut off.
Module Insert	Module {{Index}} Inserted.
Module Remove	Module {{Index}} Removed.
Power Module Insert	Power Module {{Index}} Inserted.
Power Module Remove	Power Module {{Index}} Removed.
TACACS+ Auth. Success	[Account:{{user_name}}] successfully logged in via {{interface}}.
TACACS+ Auth. Fail	[Account:{{user_name}}] log in failed via {{interface}}.
RADIUS Auth. Success	[Account:{{user_name}}] successfully logged in via {{interface}}.
RADIUS Auth. Fail	[Account:{{user_name}}] log in failed via {{interface}}.

C

SNMP MIB File

This appendix contains the SNMP MIB file for the managed switch.

The following topics are covered in this appendix:

- **Standard MIB Installation Order**
- **MIB Tree**

Standard MIB Installation Order

If you need to import the MIB one-by-one, please install the MIBs in the following order.

1. RFC1213-MIB.mib
2. SNMP-FRAMEWORK-MIB.mib
3. SNMPv2-SMI.mib
4. SNMPv2-TC.mib
5. SNMPv2-CONF.mib
6. SNMPv2-MIB.mib
7. IANAifType-MIB.mib
8. IEEE8023-LAG-MIB.mib
9. IF-MIB.mib
10. EtherLike-MIB.mib
11. IEEE8021-PAE-MIB.mib
12. BRIDGE-MIB.mib
13. P-BRIDGE-MIB.mib
14. RFC1271-MIB.mib
15. RMON-MIB.mib
16. TOKEN-RING-RMON-MIB.mib
17. RMON2-MIB.mib
18. Q-BRIDGE-MIB.mib
19. INET-ADDRESS-MIB.mib
20. IEEE8021-TC-MIB.mib
21. IEEE8021-SPANNING-TREE-MIB.mib
22. IANA-ADDRESS-FAMILY-NUMBERS-MIB.mib
23. LLDP-MIB.mib
24. LLDP-EXT-DOT1-MIB.mib
25. LLDP-EXT-DOT3-MIB.mib

MIB Tree

Refer to the following content for the MIB Tree structure.

iso(1)

| -std(0)-iso8802(8802)-ieee802dot1(1)-ieee802dot1mibs(1)

| -ieee8021paeMIB(1): IEEE8021-PAE-MIB.mib

| -ieee8021SpanningTreeMib(3): IEEE8021-SPANNING-TREE-MIB.mib

| -org(3)

| -dod(6)-internet(1)

| -mgmt(2)-mib-2(1): SNMPv2-MIB.mib

| -system(1): RFC1213-MIB.mib

| -interface(2): RFC1213-MIB.mib

| -at(3): RFC1213-MIB.mib

| -snmp(11): RFC1213-MIB.mib

| -rmon(16): RMON-MIB.mib

| -dot1dBridge(17): BRIDGE-MIB.mib, P-BRIDGE-MIB.mib, Q-BRIDGE-MIB.mib

| -ifMIB(31): IF-MIB.mib

| -etherMIB(35): EtherLike-MIB.mib

| -private(4)-moxa(8691)

| -product(600): mxGeneralInfo.mib, mxProductInfo.mib,

| -general(602): mxGeneral.mib, mxDeviceIo.mib, mxDhcpSvr.mib, mxEmailC.mib,
mxEventLog.mib,

:mxGene.mib, mxLocator.mib, mxManagementIp.mib, mxPoe.mib,
mxPorte.mib,

: mxRelayC.mib, mxSnmp.mib, mxSwe.mib, mxSysLoginPolicySvr.mib,

: mxSyslogSvr.mib, mxSysPasswordPolicySvr.mib, mxSystemInfo.mib,

: mxSysTrustAccessSvr.mib, mxSysUtilSvr.mib, mxTimeSetting.mib,

: mxTimeZone.mib, mxTrapC.mib, mxUiServiceMgmt.mib

| -switching(603): mxSwitching.mib

| - portInterfacce : mxPort.mib, mxLa.mib

| - basicLayer2: mxLhc.mib, mxQos, mxVlan.mib

| - layer2Redundancy: mxRstp.mib, mxTrv2.mib, mxTurboChain.mib,
mxDualHoming.mib

| - layer2Security: mxStcl.mib, mxRlps.mib, mxPssp.mib, mxPsms.mib, mxDot1x.mib,
mxRadius.mib

| - layer2Diagnostic: mxLldp.mib, mxTcst.mib, mxPortMirror.mib, mxRmon.mib

| - layer3Diagnostic

| - layer2Multicast: mxIgmpp.mib

```
|- layer3Multicast
|-poe(608): mxPoe.mib
|-snmpV2(6)-snmpModules(3)
|-snmpFrameworkMIB(10): SNMP-FRAMEWORK.mib
|-ieee(111)-standards-association-numbers-series-standards(2)-lan-man-stds(802)-ieee802dot1(1)-
ieee802dot1mibs(1)-ieee8021SpanningTreeMib(3): IEEE8021-SPANNING-TREE-MIB.mib
```