

EDS-205 Series Quick Installation Guide

Moxa EtherDevice Switch

Version 7.2, January 2021

Technical Support Contact Information
www.moxa.com/support

MOXA[®]

© 2021 Moxa Inc. All rights reserved.

P/N: 1802002050018



Overview

The Moxa, EDS-205 series EtherDevice™ switches are entry-level 5- port Ethernet switches that provide a cost-effective solution for your industrial Ethernet connection.

The EDS-205 Series supports DC power input from 12 to 48 V. These switches can operate from -10 to 60°C, and the rugged hardware design makes the EDS-205 switches perfect for ensuring that your Ethernet equipment can be used for demanding industrial applications.

NOTE *Throughout this Hardware Installation Guide, we use **EDS** as an abbreviation for Moxa EtherDevice Switch:*

EDS = Moxa EtherDevice Switch



ATTENTION

This device complies with part 15 of the FCC Rules. Operation is subject to the following two conditions: (1) This device may not cause harmful interference, and (2) this device must accept any interference received, including interference that may cause undesired operation.

Package Checklist

The Moxa EDS-205 is shipped with the following items. If any of these items is missing or damaged, please contact your customer service representative for assistance.

- Moxa EtherDevice™ Switch
- Quick installation guide (printed)
- Warranty card

Panel Layout of the EDS-205 Series

Top View

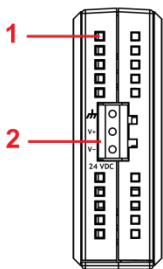

1. Heat dissipation orifices
2. Terminal block for power input and grounding
3. Moxa Logo
4. Power input LED
5. 10/100BaseT(X) Port
6. TP port's 100 Mbps LED
7. TP port's 10 Mbps LED
8. DIN-rail kit

Front View

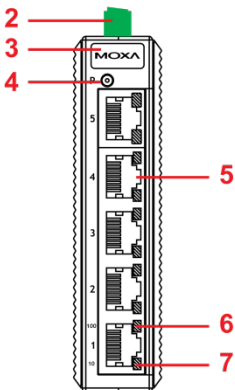

Rear View

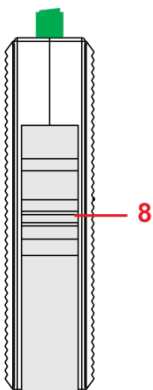

Mounting Dimensions (unit = mm)

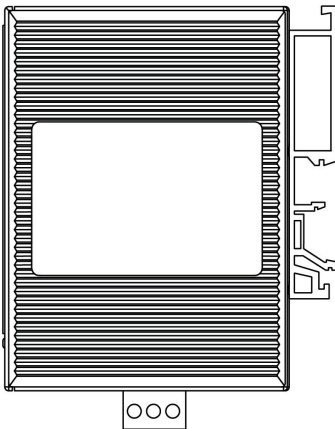
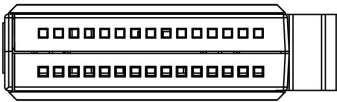
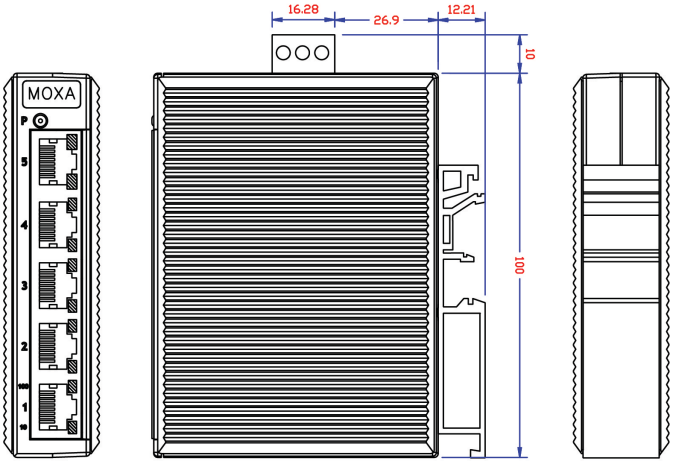
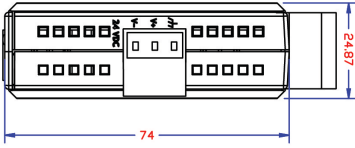

DIN-Rail Mounting

The plastic DIN-rail attachment plate should already be fixed to the rear panel of the EDS when you take it out of the box. If you need to reattach the DIN-rail attachment plate, make sure the DIN-rail kit is situated towards the top, as shown in the figures below.

STEP 1:

Insert the top of the DIN rail into the slot.



STEP 2:

The DIN-rail attachment unit will snap into place as shown below.

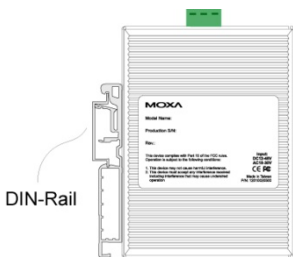

To remove Moxa EDS-205 from the DIN rail, insert a flat-blade screw driver horizontally into the DIN-rail kit under the EDS-205, and then pull it upwards and release the EDS towards you and away from the DIN rail.

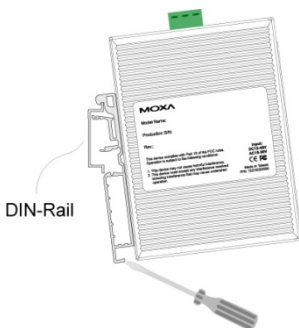

Or you may take the following steps to remove the EDS-205 from the DIN rail.

Step 1:

Press the middle of the flat side of the mounting kit as indicated. Pull the EDS-205 downwards.

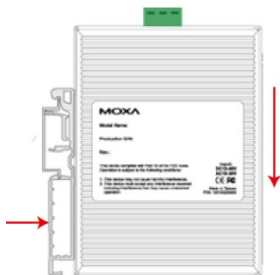

Step 2:

Release it towards you and away from the DIN rail.



Wiring Requirements



ATTENTION

Safety First!

Be sure to disconnect the power cord before installing and/or wiring your Moxa EtherDevice Switch.

Calculate the maximum possible current in each power wire and common wire. Observe all electrical codes dictating the maximum current allowable for each wire size.

If the current goes above the maximum ratings, the wiring could overheat, causing serious damage to your equipment.

You should also pay attention to the following points:

- Use separate paths to route wiring for power and devices. If power wiring and device wiring paths must cross, make sure the wires are perpendicular at the intersection point.
NOTE: Do not run signal or communications wiring and power wiring in the same wire conduit. To avoid interference, wires with different signal characteristics should be routed separately.
- You can use the type of signal transmitted through a wire to determine which wires should be kept separate. The rule of thumb is that wiring that shares similar electrical characteristics can be bundled together.
- Keep input wiring and output wiring separated.
- It is strongly advised that you label wiring to all devices in the system when necessary.

Grounding the Moxa EtherDevice Switch

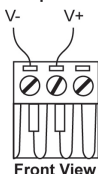

Grounding and wire routing help limit the effects of noise due to electromagnetic interference (EMI). Run the ground connection from the right most contact of the 3-contact terminal block to the grounding surface prior to connecting devices.



ATTENTION

This product is intended to be mounted to a well-grounded mounting surface such as a metal panel.

Wiring the Power Inputs

The two left-most contacts of the 3-contact terminal block connector on the EDS's top panel are used for the DC input. Top and front views of one of the terminal block connectors are shown here.

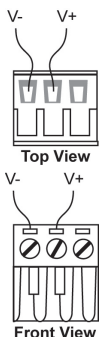

STEP 1:

Insert the negative/positive DC wires into the V-/V+ terminals.

STEP 2:

To keep the DC wires from pulling loose, use a small flat-blade screwdriver to tighten the wire-clamp screws on the front of the terminal block connector.

STEP 3:

Insert the plastic terminal block connector prongs into the terminal block receptor, which is located on the EDS's top panel.



ATTENTION

- Only connect to a class 2 power supply.
- Only use 60/75°C copper (CU) wire, 28-12 AWG.
- Use a maximum torque of 4.5 in-lb.

Communication Connections

The EDS-205 has five 10/100BaseT(X) Ethernet ports.

10/100BaseT(X) Ethernet Port Connection

The 10/100BaseT(X) ports located on the EDS switch's front panel are used to connect to Ethernet-enabled devices.

Below we show pinouts for both MDI (NIC-type) ports and MDI-X (HUB/Switch-type) ports, and also show cable wiring diagrams for straight-through and cross-over Ethernet cables.

10/100Base T(x) RJ45 Pinouts

MDI Port Pinouts

Pin	Signal
1	Tx+
2	Tx-
3	Rx+
6	Rx-

MDI-X Port Pinouts

Pin	Signal
1	Rx+
2	Rx-
3	Tx+
6	Tx-

8-pin RJ45

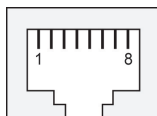

RJ45 (8-pin) to RJ45 (8-pin) Straight-Through Cable Wiring

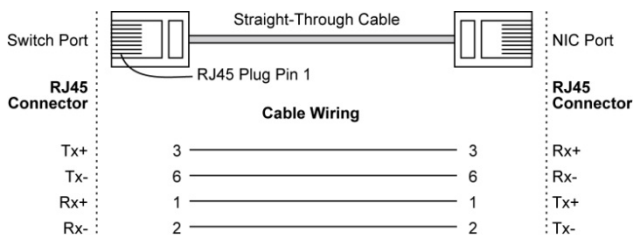

RJ45 (8-pin) to RJ45 (8-pin) Cross-Over Cable Wiring

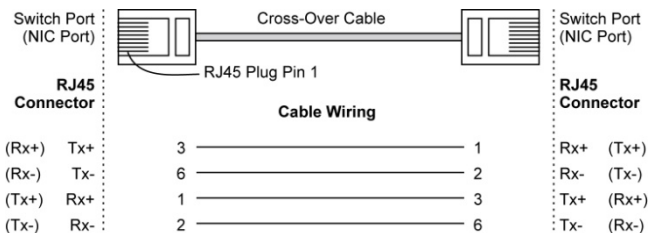

LED Indicators

The front panel of the Moxa EtherDevice Switch contains several LED indicators. The function of each LED is described in the table below.

LED	Color	State	Description
P	AMBER	On	Power is being supplied to the power input.
		Off	Power is not being supplied to the power input.
10M (TP)	GREEN	On	The TP port's 10 Mbps link is active.
		Blinking	Data is being transmitted at 10 Mbps.
		Off	The TP port's 10 Mbps link is inactive
100M (TP)	GREEN	On	The TP port's 100 Mbps link is active.
		Blinking	Data is being transmitted at 100 Mbps.
		Off	The 100BaseTX port's link is inactive.

Auto MDI/MDI-X Connection

The Auto MDI/MDI-X function allows users to connect the switch's 10/100BaseTX ports to any kind of Ethernet device, regardless of the type of Ethernet cable being used for the connection. This means that you can use either a straight-through or cross-over cable to connect the EDS to your Ethernet devices.

Dual Speed Functionality and Switching

The switch's 10/100 Mbps switched RJ45 port auto negotiates with the connected device for the fastest data transmission rate supported by both devices. All models of Moxa EtherDevice Switch are plug-and-play devices; software configuration is not required at installation, or during maintenance. The half/full duplex mode for the switched RJ45 ports is user dependent and changes (by auto-negotiation) to full or half duplex, depending on which transmission speed is supported by the attached device.

Switching, Filtering, and Forwarding

Each time a packet arrives at one of the switched ports, a decision is made to either filter or forward the packet. Packets with source and destination addresses belonging to the same port segment will be filtered, constraining those packets to one port, and relieving the rest of the network from the need to process them. A packet with destination address on another port segment will be forwarded to the appropriate port, and will not be sent to the other ports where it is not needed. Packets that are used to maintain the operation of the network (such as the occasional multi-cast packet) are forwarded to all ports. The switch operates in the store-and-forward switching mode, which eliminates bad packets and enables peak performance to be achieved when there is heavy traffic on the network.

Switching and Address Learning

The Moxa EtherDevice switch has an address table that can hold up to 1K node addresses, making it suitable for use with large networks. The address tables are self-learning, so that as nodes are added or removed, or moved from one segment to another, the switch automatically adds new node locations to the tables. An address-aging algorithm causes the least-used addresses to be deleted in favor of newer, more frequently used addresses. To reset the address buffer, power down the unit and then power it back up.

Auto-Negotiation and Speed Sensing

All of the switch's RJ45 Ethernet ports independently support auto-negotiation for speeds in the 10BaseT and 100BaseTX modes, with operation according to the IEEE 802.3u standard. This means that some nodes could be operating at 10 Mbps, while at the same time, other nodes are operating at 100 Mbps.

Auto-negotiation takes place when an RJ45 cable connection is made, and then each time a LINK is enabled. The Moxa EtherDevice switch advertises its capability for using either 10 Mbps or 100 Mbps transmission speeds, with the device at the other end of the cable expected to similarly advertise. The two devices will agree to operate at either 10 Mbps or 100 Mbps.

If a Moxa EtherDevice switch's RJ45 Ethernet port is connected to a non-negotiating device, it will default to 10 Mbps speed and half-duplex mode, as required by the IEEE 802.3u standard.

Specifications

Technology	
Standards	IEEE802.3, 802.3u, 802.3x
Processing Type	Store and Forward, with IEEE802.3x full duplex, non-blocking flow control
Address Table Size	1K unicast addresses
Interface	
RJ45 Ports	10/100BaseT(X) auto negotiation speed, F/H duplex mode, and auto MDI/MDI-X connection
LED Indicators	Power, 10/100 M

Power	
Input Voltage	12 to 48 VDC
Input Current	0.12 A @ 24 V
Power Consumption	5 W
Connection	Removable 3-contact terminal block
Overload Current Protection	1.1 A
Reverse Polarity Protection	Present
Mechanical	
Casing	IP30 protection, plastic housing
Dimensions	25 x 109 x 88 mm
Weight	135 g
Installation	DIN-rail mounting
Environmental Limits	
Operating Temperature	-10 to 60°C (14 to 140°F)
Storage Temperature	-40 to 70°C (-40 to 158°F)
Ambient Relative Humidity	5 to 95% (non-condensing)
Regulatory Approvals	
Safety	UL508
EMI	FCC Part 15, CISPR (EN55032) class A
EMS	EN61000-4-2 (ESD) , level 2 EN61000-4-3 (RS) , level 3 EN61000-4-4 (EFT) , level 3 EN61000-4-5 (Surge) , level 3 EN61000-4-6 (CS) , level 3
Shock	IEC 60068-2-27
Freefall	IEC 60068-2-32
Vibration	IEC 60068-2-6
WARRANTY	
Time Period	5 years
Details	www.moxa.com/warranty