

UC-8410A Hardware User Manual

Version 2.3, June 2022

www.moxa.com/products

MOXA®

© 2022 Moxa Inc. All rights reserved.

UC-8410A Hardware User Manual

The software described in this manual is furnished under a license agreement and may be used only in accordance with the terms of that agreement.

Copyright Notice

© 2022 Moxa Inc. All rights reserved.

Trademarks

The MOXA logo is a registered trademark of Moxa Inc.
All other trademarks or registered marks in this manual belong to their respective manufacturers.

Disclaimer

- Information in this document is subject to change without notice and does not represent a commitment on the part of Moxa.
- Moxa provides this document as is, without warranty of any kind, either expressed or implied, including, but not limited to, its particular purpose. Moxa reserves the right to make improvements and/or changes to this manual, or to the products and/or the programs described in this manual, at any time.
- Information provided in this manual is intended to be accurate and reliable. However, Moxa assumes no responsibility for its use, or for any infringements on the rights of third parties that may result from its use.
- This product might include unintentional technical or typographical errors. Changes are periodically made to the information herein to correct such errors, and these changes are incorporated into new editions of the publication.

Technical Support Contact Information

www.moxa.com/support

Table of Contents

1. Introduction	4
Overview	4
Package Checklist	4
Product Features	4
Specifications	5
2. Appearance and Dimensions	6
Appearance	6
Dimensions	7
LED Indicators	7
Diagnostic LEDs	8
Reset Button	8
Real-time Clock	9
3. Mounting Options	10
Installing the UC-8410A	10
Wall or Cabinet	10
DIN Rail	11
4. Hardware Connection Description	13
Wiring Requirements	13
Connecting the Power	13
Connecting to the Network	14
Connecting to a Serial Device	15
Connecting to the Console Port	15
Installing the SD Card and mSATA Card	16
USB	17
DI/DO	17
Digital Input Wiring	17
Digital Output Wiring	18
Installing the Wireless Modules (not available in the -NW module)	18
Installing the Wi-Fi Module	19
Installing the Cellular Module	22
Installing the SIM Card	26
A. Regulatory Approval Statements	27

1. Introduction

Thank you for purchasing the Moxa UC-8410A RISC-based dual-core ready-to-run embedded computer.

This manual introduces the hardware features of the computer and provides step-by-step instructions on installing and configuring the hardware.

Overview

The UC-8410A computer comes with various communication interfaces, which make it an ideal communication platform for industrial applications. The communication interfaces include eight RS-232/422/485 serial ports, three 10/100/1000 Mbps Ethernet ports, four digital input and four digital output channels, and a wireless communication slot (not available in the –NW model). In addition, the UC-8410A is provided with a mSATA slot for storage expansion, and 2 USB ports for additional memory (such as a USB flash drive). The computer is built using a NXP Cortex-A7 dual-core 1 GHz RISC CPU. This powerful computing engine supports several useful communications functions but will not generate too much heat. The computer's built-in 8 GB eMMC and 1 GB DDR3 SDRAM give you sufficient memory to run your application software while the SD slot and mSATA socket provide you the flexibility to expand the data storage capacity.

Package Checklist

Before installing the UC-8410A, verify that the following items are in the package:

- UC-8410A embedded computer
- Wall-mounting kit
- Power jack
- 3-pin terminal block for power
- CBL-4PINDB9F-100: 4-pin pin header to DB9 female console port cable, 100 cm
- Quick installation guide (printed)
- Warranty card



NOTE

Please notify your sales representative if any of the above items are missing or damaged.

Product Features

- NXP LS1021A Cortex-A7 1 GHz dual-core processor
- 8 GB eMMC with OS preinstalled
- 1 GB DDR3 SDRAM
- 8 x RS-232/422/485 serial ports
- 3 x 10/100/1000 Mbps Ethernet ports
- 1 x Mini-PCIe socket for wireless expansion (not available in the –NW model)
- -40 to 75°C system operating temperature
- Ready-to-run Debian 8/Debian 9

Specifications



NOTE

For the product specifications, refer to www.moxa.com.

2. Appearance and Dimensions

Appearance

Front View



NOTE

The -NW model is not provided with the antenna connectors and SIM card socket. However, all models come with a cover.

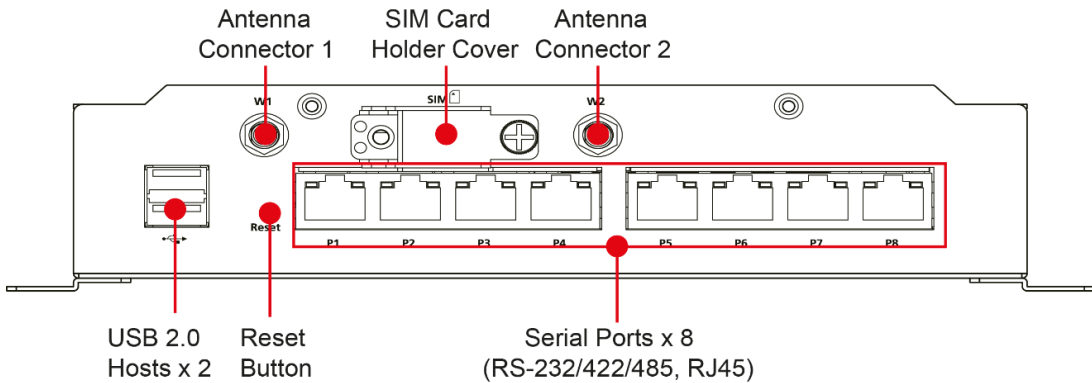

Rear View

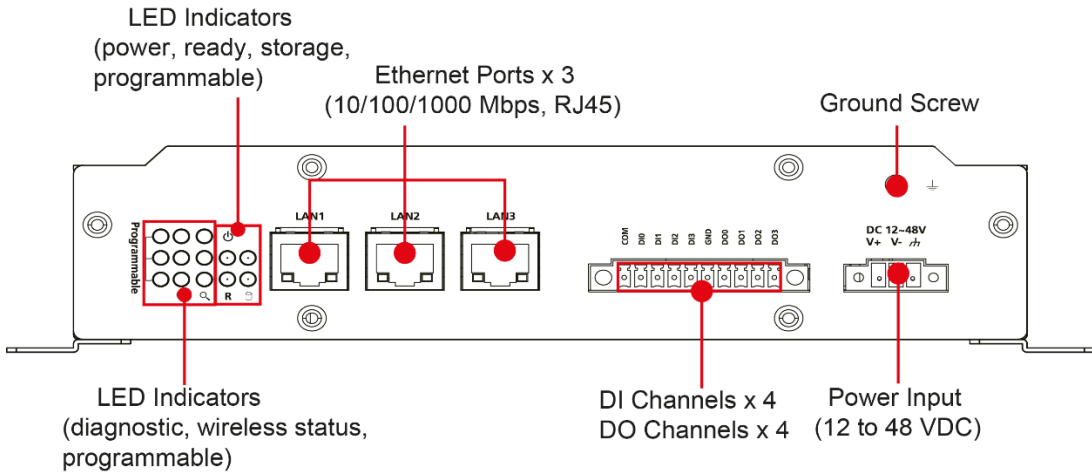

Left-Side View

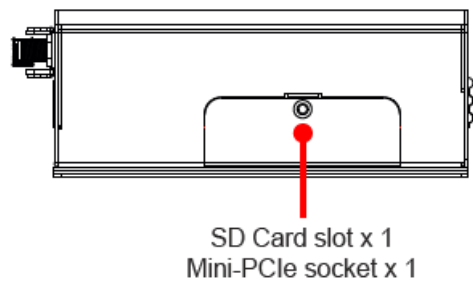

Dimensions

Unit: mm (inch)

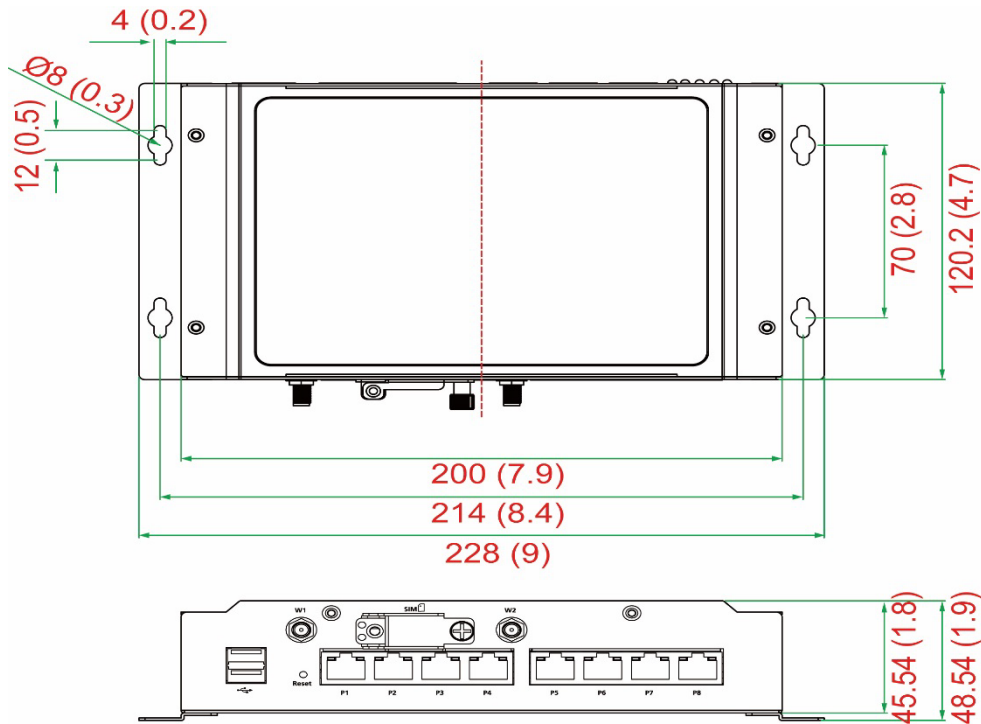

LED Indicators

Refer to the following table for information about the LEDs:

LED Name	Status	Function
Power	Green	Power is on
	Off	No power input or any other power error
Ready	Green	System is ready
	Off	OS boot up failure or other system initialization error
WAN	Yellow	Steady On: 1000 Mbps Ethernet link Blinking: Data transmission is in progress
	Green	Steady On: 100 Mbps Ethernet link Blinking: Data transmission is in progress
	Off	Speed at 10 Mbps or WAN is not connected
LAN	Yellow	Steady On: 1000 Mbps Ethernet link Blinking: Data transmission is in progress
	Green	Steady On: 100 Mbps Ethernet link Blinking: Data transmission is in progress
	Off	Speed at 10 Mbps or LAN is not connected
Serial	Green	Blinking: Data transmission is in progress
	Yellow	Blinking: Receiving Data
	Off	No operation
Storage	Yellow	Blinking: Access to SD card or mSATA module
	Off	The SD card or the mSATA module is not accessible.
Programmable	Green	Programmable
	Green	Programmable
	Green	Programmable

LED Name	Status	Function
Wireless	Green	The number of glowing LEDs indicate the wireless signal strength as follows: 3 Green: Excellent 2 Green: Good 1 Green: Poor Note: The wireless LEDs are disabled on the –NW model.
	Off	No wireless signal or wireless signal failure
Diagnostic	Green/Yellow/Red	Various combinations of the on/off/blinking statuses of the Green/Yellow/Red LEDs indicate different hardware diagnostic statuses. Refer to the Diagnostic LEDs section for details.

Diagnostic LEDs

The descriptions of the statuses indicated by the diagnostic LEDs are listed in the table below:

Priority	Green	Yellow	Red	Status Description
1	On	Off	Blinking	Self-diagnosis in progress
2	Off	Off	On	LAN1 Ethernet controller error
3	Blinking	Off	On	LAN2 Ethernet controller error
4	On	Off	On	LAN3 Ethernet controller error
5	Off	On	On	UART interface error—indicates an error in any one of the UART interfaces
6	Blinking	Blinking	Blinking	LED device issue
7	Off	Blinking	On	Button device issue
8	On	Blinking	Blinking	Ready for reset to factory default
9	Off	On	Blinking	CPU usage (over 90%)
10	Off	On	Off	RAM usage (over 90%)
11	Blinking	On	Off	Disk usage (over 90%)
12	Blinking	On	Blinking	File system corrupted
13	Blinking	Blinking	On	TPM device issue

Reset Button

The **Reset** button returns the UC-8410A to its factory default configuration and performs the system diagnostic function. Please check the table below for details:

Function	Button Operation
Self-diagnosis	The Red LED will start blinking once you press the Reset button. Keep the button pressed until the Green LED lights up for the first time and then release the button to enter the diagnostic mode. Refer to the Diagnostic LEDs section for details.
Resetting the computer to the factory default configuration	The Red LED will start blinking once you press the Reset button. Keep the button pressed until the green LED lights up for the second time and then release the button to enter the process of resetting the computer to the factory default.

We recommend that you only use this function if the software is not working properly, and you want to load the factory default settings. To reset an embedded system, always use the software reboot command `/>reboot` to protect the integrity of data being transmitted or processed.



ATTENTION

Reset button preserves user data

The **Reset** button will NOT format the user directory or erase the user data. Pressing the **Reset** button continuously for at least 5 seconds will only load the configuration file. For the Linux OS, all files in the `/etc`, `/home`, and `/tmp` directories will revert to their factory defaults, but other user data will still exist in the Flash ROM. For the Windows CE 6.0 OS, all registry configurations will revert to the factory default.

Real-time Clock

The UC-8410A's real-time clock is powered by a lithium battery. We strongly recommend that you do not replace the lithium battery without help from a qualified Moxa support engineer. If you need to change the battery, contact the Moxa RMA service team.



WARNING

There is a risk of explosion if the battery is replaced by an incorrect type of battery.

3. Mounting Options

Installing the UC-8410A

Wall or Cabinet

The two metal brackets included with the UC-8410A can be used to attach it to a wall or the inside of a cabinet. Use two screws per bracket to attach the brackets to the bottom panel of the UC-8410A.

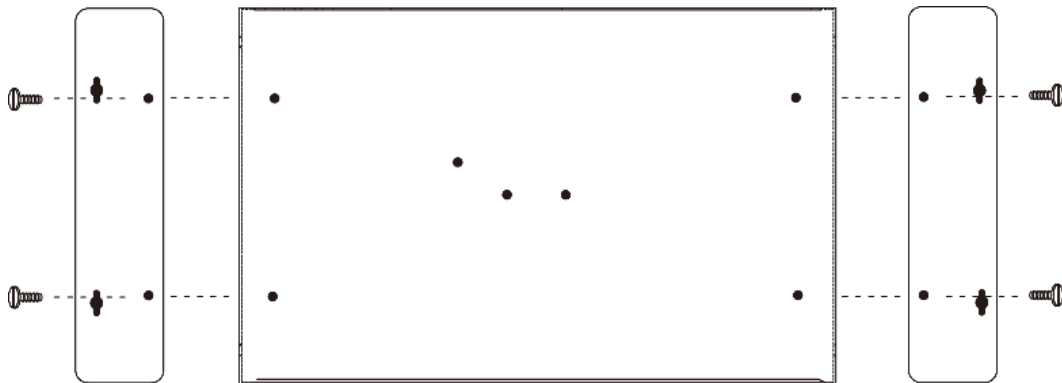

The four screws are included in the wall-mounting kit. Refer to the figure on the right for detailed specification of the screws.

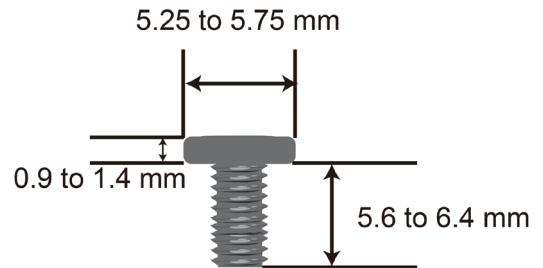

Next, use two screws per bracket to attach the UC-8410A to a wall or cabinet.



These four screws are NOT included in the wall-mounting kit and must be purchased separately. Refer to the detailed specifications on the right.

Head Type: round or pan
Head Diameter: >4.5 mm
Length: >4 mm
Thread Size: M3 x 0.5 mm

DIN Rail

The DIN-rail mounting kit includes a black plate, a silver DIN-rail mounting plate, and six screws. To install the computer on a DIN rail, do the following:

Find the two screw holes on the bottom side of the computer.

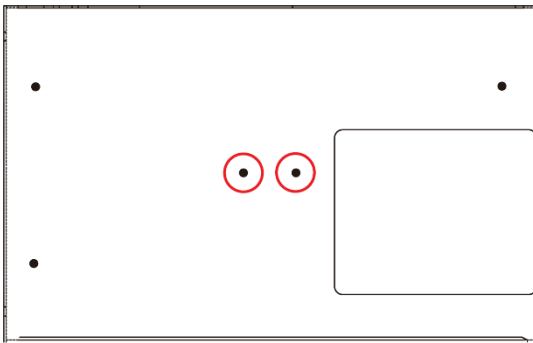

Use two screws to attach the black plate to the computer.

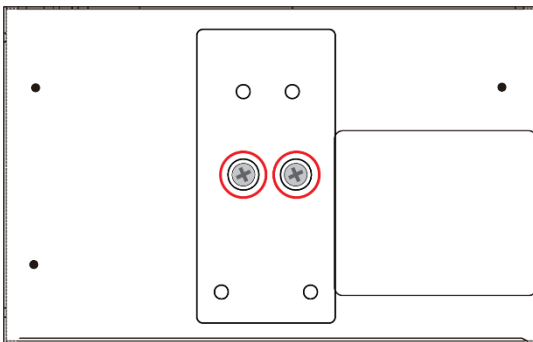

Use another four screws to attach the DIN-rail mounting plate as shown in the figure below:.

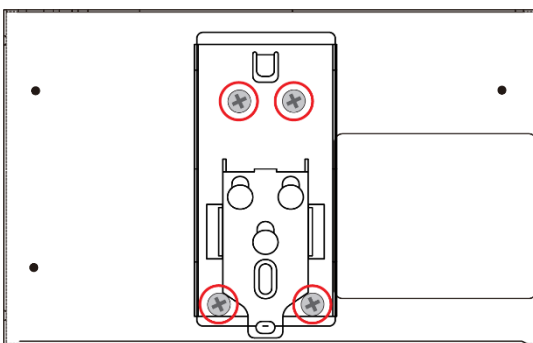

Refer to the figure on the right for the specifications of the mounting screws.

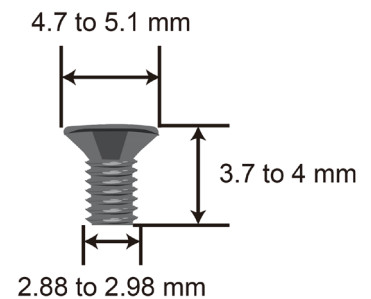

To install the computer on a DIN rail, follow these steps:

Step 1—Insert the upper lip of the mounting plate into the DIN rail.

Step 2—Press the UC-8410A computer towards the DIN rail until it snaps into place.

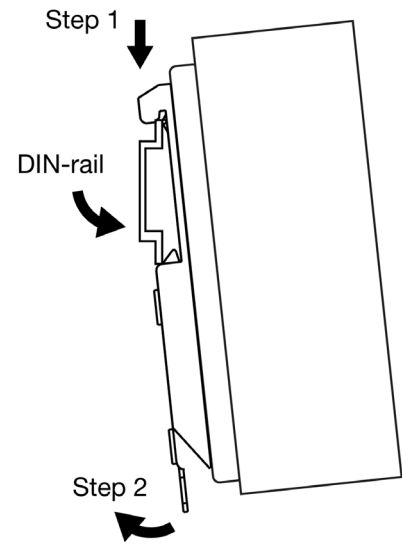

To remove the computer from the DIN rail, follow these steps:

Step 1—Pull down the latch on the DIN-rail mounting plate with a screwdriver.

Steps 2 & 3—Slightly pull the computer forward and lift it up to detach the computer from the DIN rail.

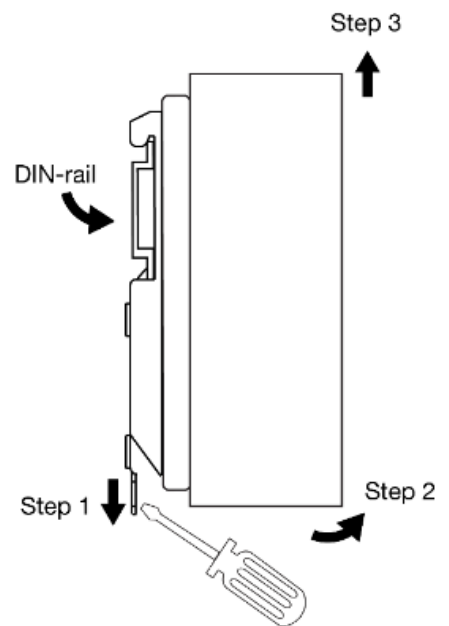

4. Hardware Connection Description

This chapter describes how to connect the UC-8410A to serial devices.

Wiring Requirements



ATTENTION

Safety First!

Be sure to disconnect the power cord before installing and/or wiring your UC-8410A.

Wiring Caution!

Calculate the maximum possible current in each power wire and common wire. Observe all electrical codes that dictate the maximum current allowed for each wire size. If the current goes above the maximum ratings, the wiring could overheat, causing serious damage to your equipment.

Temperature Caution!

Be careful when handling the UC-8410A. When plugged in, the UC-8410A's internal components generate heat, and the outer casing may feel hot to the touch.

You should also observe the following common wiring rules:

- Use separate paths to route wiring for power and devices. If power wiring and device wiring paths must cross, make sure the wires are perpendicular at the intersection point.



NOTE

Do not run signal or communication wiring and power wiring in the same wire conduit. To avoid interference, wires with different signal characteristics should be routed separately.

- You can use the type of signal transmitted through a wire to determine which wires should be kept separate. The rule of thumb is that wiring that shares similar electrical characteristics can be bundled together.
- Keep input wiring and output wiring separate.
- We strongly recommend that you label wiring to all devices in the system for easy identification.

Connecting the Power

The UC-8410A has a 3-pin terminal block for a 12 to 48 VDC power input.

The following figures show how the power input interface connects to an external power source. If the power is properly supplied, the **Ready** LED will illuminate a solid Green color after 30 to 60 seconds have passed.

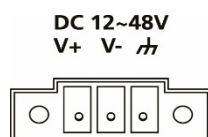



ATTENTION

The power for this product is intended to be supplied by a Listed Power Supply Unit that is rated to deliver 12 to 48 VDC at a minimum of 1010 mA for 12 VDC, and 240 mA for 48 VDC.

Grounding the UC-8410A

Grounding and wire routing help limit the effects of noise due to electromagnetic interference (EMI). Run the ground connection from the ground screw to the grounding surface prior to connecting devices.



ATTENTION

This product is intended to be mounted to a well-grounded mounting surface, such as a metal panel.

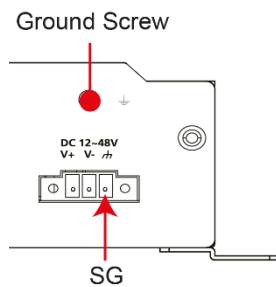

SG: The *Shielded Ground* (sometimes called Protected Ground) contact is the right most contact of the 3-pin power terminal block connector when viewed from the angle shown here. Connect the SG wire to an appropriate grounded metal surface. An additional ground connector is provided just above the power block, which you can use for additional grounding protection.



ATTENTION

A shielded-type power cord is required to meet FCC emission limits and to prevent interference to nearby radio and television reception. It is essential that only the power cord supplied with the unit is used to supply power.

You are cautioned that changes or modifications not expressly approved by the party responsible for compliance could void your authority to operate the equipment.

Connecting to the Network

Connect one end of the Ethernet cable to one of the UC-8410A's 10/100/1000 Mbps Ethernet ports (8-pin RJ45) and the other end of the cable to the Ethernet network. If the cable is properly connected, the UC-8410A will indicate a valid connection to the Ethernet in the following ways:

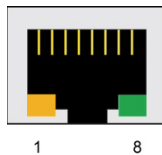

The lower right corner LED indicator maintains a solid green color when the cable is properly connected to a 100 Mbps Ethernet network. The LED will flash on and off when Ethernet packets are being transmitted or received.

The lower left corner LED indicator maintains a solid orange color when the cable is properly connected to a 10 Mbps Ethernet network. The LED will flash on and off when Ethernet packets are being transmitted or received.

PIN	10/100 Mbps	1000 Mbps
1	ETx+	TRD(0)+
2	ETx-	TRD(0)-
3	ERx+	TRD(1)+
4	-	TRD(2)+
5	-	TRD(2)-
6	ERx-	TRD(1)-
7	-	TRD(3)+
8	-	TRD(3)-

Connecting to a Serial Device

Use properly wired serial cables to connect the UC-8410A to serial devices. The UC-8410A's serial ports (P1 to P8) use 8-pin RJ45 connectors. The ports can be configured by software for RS-232, RS-422, or 2-wire RS-485. The precise pin assignments are shown in the following table:

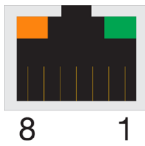

Pin	RS-232	RS-422/ RS-485-4w	RS-485-2w
1	DSR	-	-
2	RTS	TXD+	-
3	GND	GND	GND
4	TXD	TXD-	-
5	RXD	RXD+	Data+
6	DCD	RXD-	Data-
7	CTS	-	-
8	DTR	-	-

Connecting to the Console Port

The UC-8410A's console port is a 4-pin pin header RS-232 port. Refer to the following figure for the pin assignments of the console port cable:

Serial Console Port and Pinouts



Pin	Signal
1	TXD
2	RxD
3	NC
4	GND

Serial Console Cable



The console port is located below the mSATA/SD socket. Use a screwdriver to remove the two screws holding the cover to the embedded computer's housing.

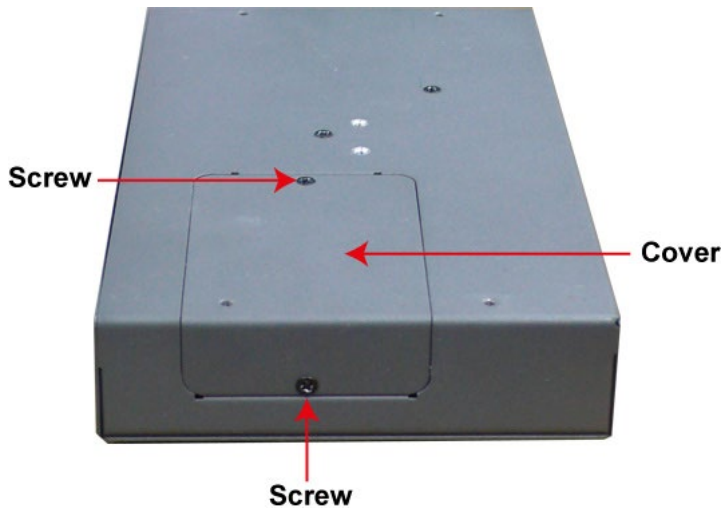

Refer to the following figure for the location of the console port.

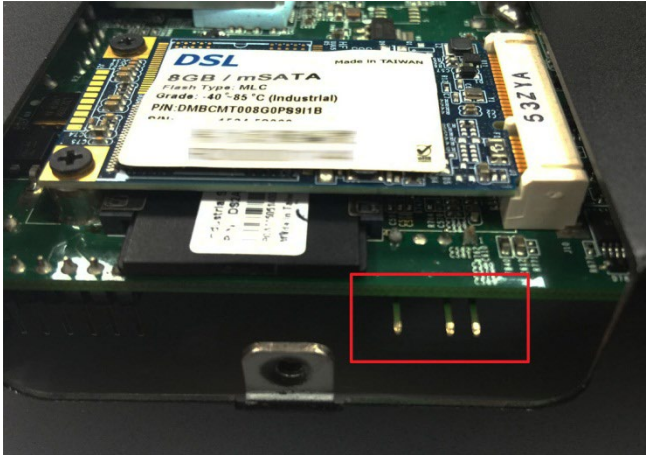

Installing the SD Card and mSATA Card

The UC-8410A comes with a SD card slot and a mSATA socket for storage expansion. To replace or install the SD card, or to install a mSATA card, follow these steps:

1. Use a screwdriver to remove the screws on the rear and side panels of the cover over the mSATA socket.



2. Remove the cover to access the SD-card slot and the mSATA socket.



3. Push the SD card in gently to release it and remove the SD card to insert a new one in the socket.
4. Insert the mSATA card into the socket and fasten the screws.



NOTE

The mSATA card is NOT included in the product package and must be purchased separately. All standard mSATA card types have been tested with the UC-8410A computer and have been found to work normally.

USB

The UC-8410A has 2 USB 2.0 hosts for external storage expansion. The USB hosts are located on the front panel.

DI/DO

The UC-8410A has 4 channels for digital outputs and 4 channels digital inputs. The I/O pinouts are shown in the following figures:

Digital Input Wiring

Dry Contact

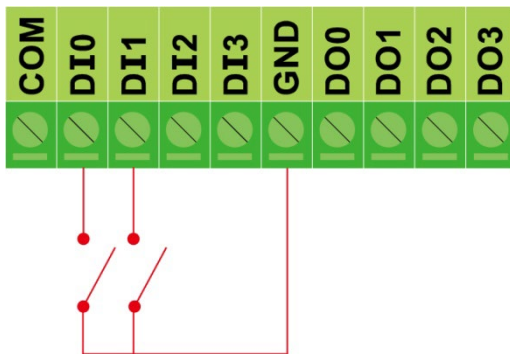

Wet Contact

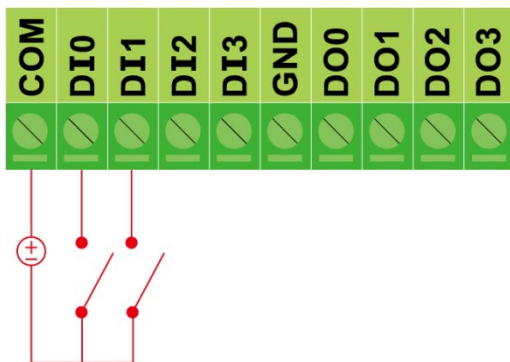

NOTE

If you are using wet contacts, you must connect the "COM" pin to power.

Digital Output Wiring

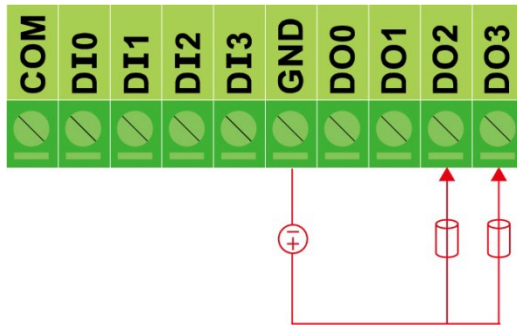

Installing the Wireless Modules (not available in the -NW module)

The UC-8410A comes with one internal socket that allows you to install either a Wi-Fi module or a cellular module.

To install a wireless module you must first remove the four screws on the top panel, two screws on the front panel, and two screws on the rear panel, and remove the top cover of the UC-8410A. See the following figures for details on the location of the screws:

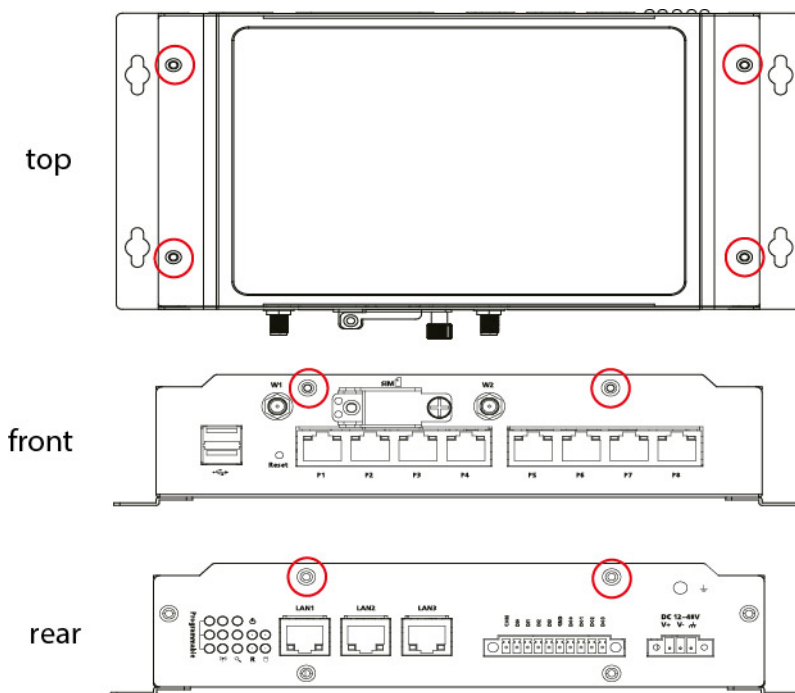

NOTE

The top cover comes loose only after you have removed all eight screws as indicated in the diagrams.

Installing the Wi-Fi Module

The Wi-Fi module package includes 1 Wi-Fi module, 2 Wi-Fi antenna cables and connectors, 1 thermal pad, 2 black screws, 2 locking washers, and 2 nuts.

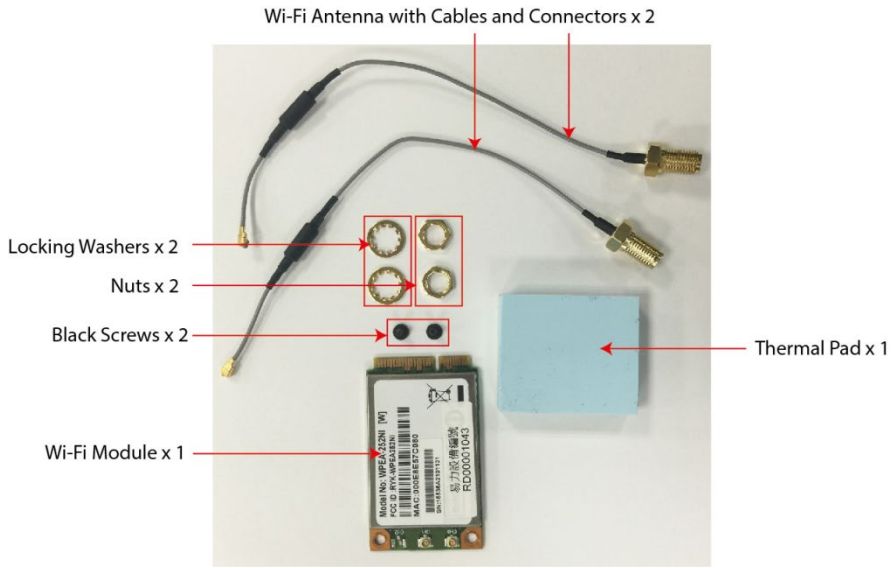

Follow these steps to install the Wi-Fi module.

1. Find the location of the module socket.

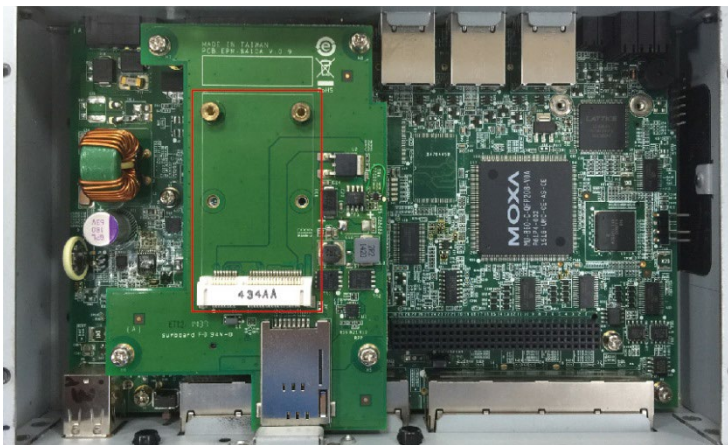

2. Insert the module in the socket and fasten the two black screws on to the module.

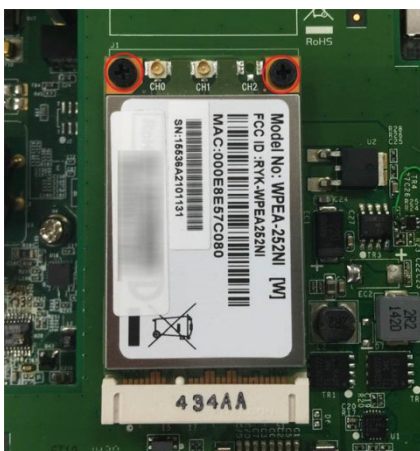

3. Attach one end of the Wi-Fi cable to the connector marked CH0 and connect the other end of the cable to the W1 connector aperture on the front panel of the computer. Remove the black antenna hole protection cover before you do so.

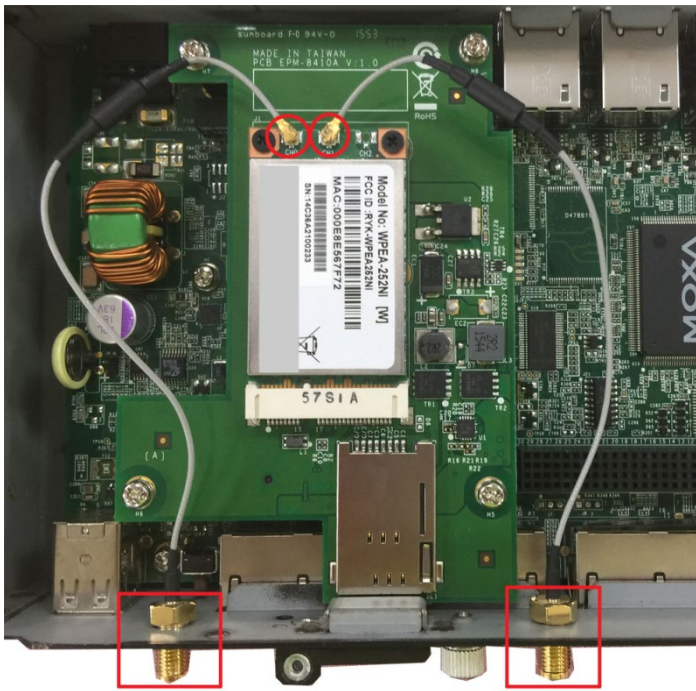

4. Pass the antenna mount's threaded connection ring through the mounting hole, hold the locking washer against the front panel and secure the antenna connector by tightening the nut onto the threaded protection ring.



Use the method described in steps 3 and 4 to connect the second antenna cable. Attach one end of the Wi-Fi cable on the connector marked CH1, and then connect the other end of the cable on the W2 aperture on the front panel of the computer. When finished, connect the antenna.

5. Place the thermal pad on the module and check to make sure the internal antenna wire is securely connected to the Wi-Fi module.



6. Connect the Wi-Fi antenna to the computer via the connector provided on the front panel.



7. Reattach the cover on to the computer and fasten the screws to secure it.

Installing the Cellular Module

The package includes 1 cellular module, 2 cellular/GPS antenna cables and connectors, 2 thermal pads, 2 screws, 2 locking washers, and 2 nuts.

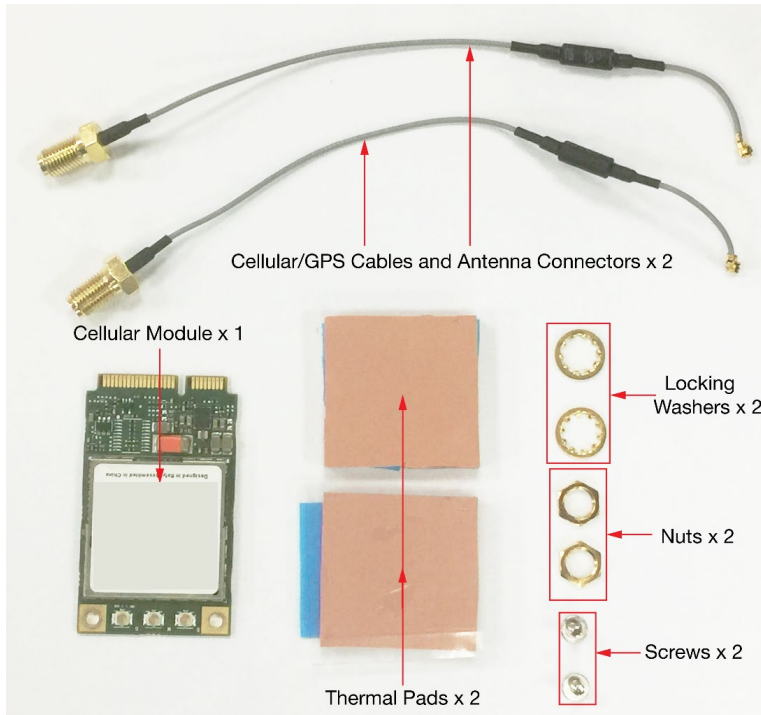

Follow these steps to install the cellular module:

1. Find the location of the module socket.

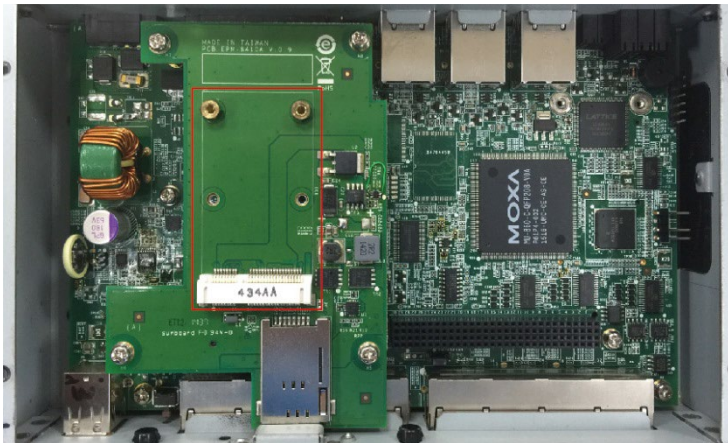

2. Stick one of the thermal pads on the module socket.
Remove the plastic cover on one side of the thermal pad and the blue cover on the other side before sticking the thermal pad to the socket.

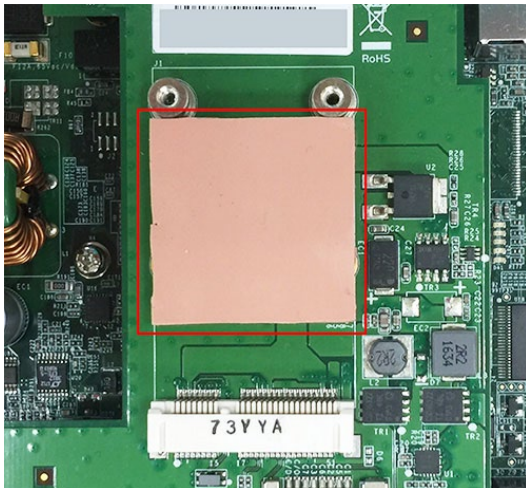

3. Insert the module into the socket and fasten the two screws to secure the module to the socket.

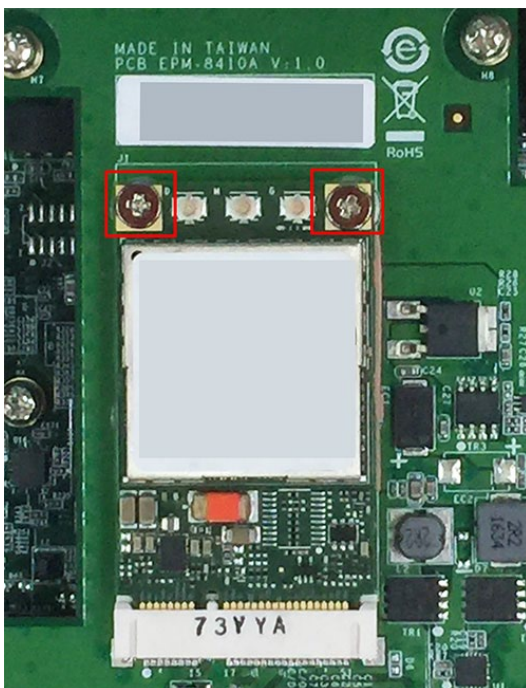

- Find the three cable connectors below the module. Note that G is for the GPS antenna, and N (in the middle) is for the cellular antenna.

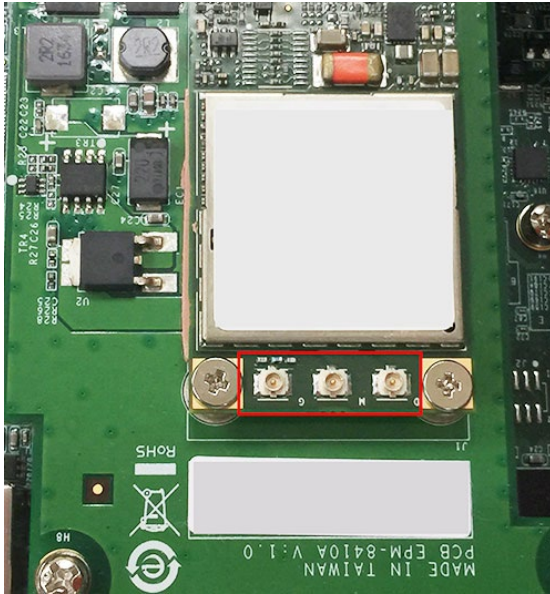

- Attach one end of the cellular antenna cable to the connector marked N and connect the other end of the cable to the W1 aperture on the front panel of the computer. Use the same method to connect the GPS cable and its connector to the W2 aperture on the front panel of the computer. Remove the black antenna hole protection cover before you do so.

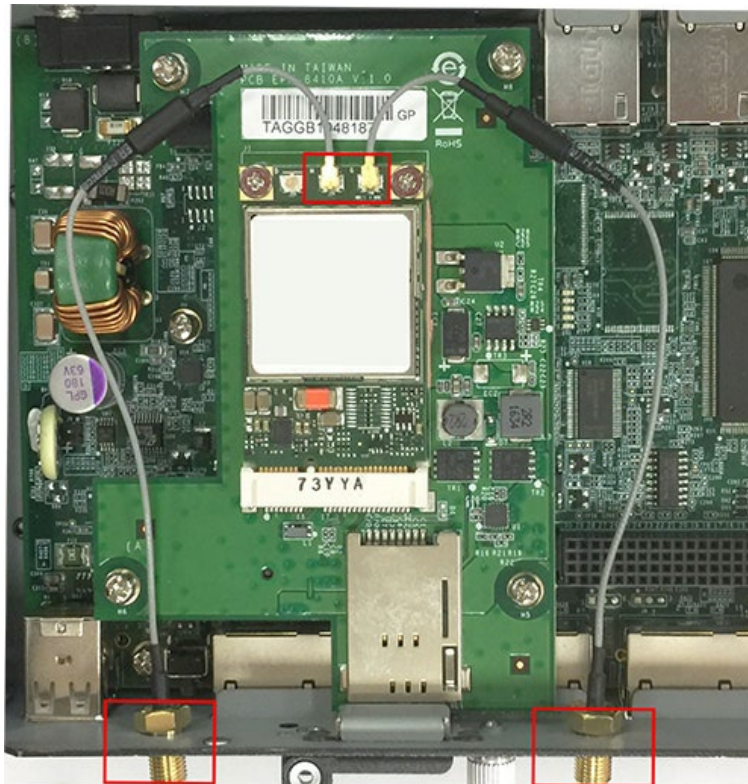

- Pass the antenna mount's threaded connection ring through the mounting hole while keeping the locking washer against the front panel.

- Secure the antenna connector by tightening the nut onto the threaded protection ring.



- Stick the other thermal pad on to the module and check to make sure the internal antenna wires are securely connected to the cellular module.

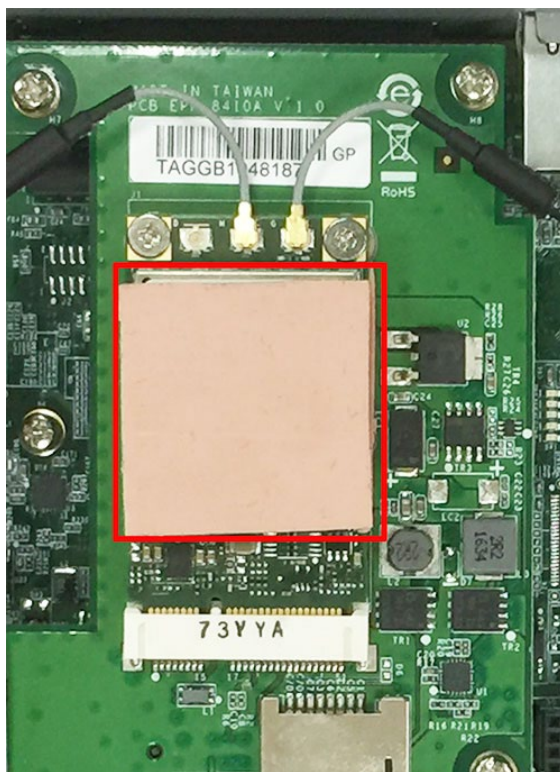

- Connect the cellular antenna to the computer via the connectors on the front panel.



- Reattach the cover on to the computer and fasten the screws to secure it in place.

Installing the SIM Card

Follow these steps to install the SIM card for the cellular module.

1. Unfasten the screw on the SIM card holder cover located on the front panel of the computer.

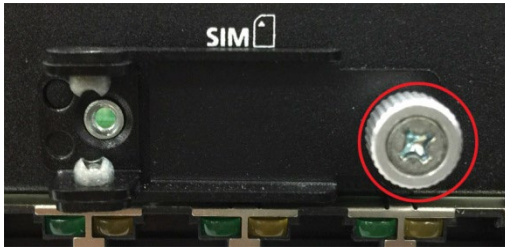

2. Insert the SIM card into the slot. Make sure you insert the card in the direction indicated above the card slot.



3. Close the cover and secure it with a screw.

A. Regulatory Approval Statements



This device complies with part 15 of the FCC Rules. Operation is subject to the following two conditions: (1) This device may not cause harmful interference, and (2) this device must accept any interference received, including interference that may cause undesired operation.